

Project

Curiosities of Civil Aviation Scientifically Explained for Passengers - Insight and Entertainment

Author: Raschiq Moschtaq

Supervisor: Prof. Dr.-Ing. Dieter Scholz, MSME
Submitted: 05.07.2018

*Faculty of Engineering and Computer Science
Department of Automotive and Aeronautical Engineering*

© This work is protected by copyright

The work is licensed under a Creative Commons Attribution-NonCommercial-ShareAlike 4.0 International License: CC BY-NC-SA

<http://creativecommons.org/licenses/by-nc-sa/4.0>



Any further request may be directed to:

Prof. Dr.-Ing. Dieter Scholz, MSME

E-Mail see: <http://www.ProfScholz.de>

This work is part of:

Digital Library - Projects & Theses - Prof. Dr. Scholz

<http://library.ProfScholz.de>

Published by

Aircraft Design and Systems Group (AERO)

Department of Automotive and Aeronautical Engineering

Hamburg University of Applied Science

Abstract

The aim of this project is to uncover some selected peculiarities and secrets of aviation and to explain them clearly to the reader. The points listed are limited solely to commercial passenger aviation, but cover various independent topics such as the cabin, the aircraft systems, the airline and many more. The depth of the elaboration of the respective topic depends significantly on the complexity of the same. Depending on the situation, visualizations in the form of figures, tables and graphics are used, and the simplest basic physical-technical knowledge is required. The explanation takes place in a scientific-theoretical and nevertheless entertaining manner. In total, 13 curiosities are analysed and subsequently assessed. The individual points which this thesis deals with were selected in such a way that in practice they arouse interest, but in part also incomprehension, and are usually not self-explanatory. The elaboration starts exactly at this point and breaks down the respective aspects. Starting with a basic investigation of the lift force, a decision is made in the further proceeding whether to attach winglets. This is followed by various topics, including aircraft windows, the primary structure as a Farady cage, but also topics concerning the cabin as the cabin air and oxygenmasks. Later, emergency procedures such as engine failure and fuel dumping are analyzed. The insight into potential future materials in aviation industry is followed by an outlook on autonomous flying after showing how dangerous the current trend towards longer working hours for cockpit staff is.

Curiosities of Civil Aviation Scientifically Explained for Passengers – Insight and Entertainment

Task for a *Project*

Background

In advanced regions of the world, flying has become a matter of course, making aviation an ever-growing industry. Although aviation is an almost essential part of our lives, the general public still often lacks a fundamental understanding of the physical and operational characteristics of aviation. In reality, despite the high complexity of aviation, efforts are being made to ensure a pleasant and thus smooth flight for the paying passenger, which denies many people an insight behind the facade of aircraft and aviation-specific processes. Aviation is so close to us, yet so far away.

Task

The task is inspired by the article "The 31 biggest secrets of air travel" published in "The Telegraph" on 2017-09-09. The investigation should deal with the following aspects:

- Aerodynamic Lift
- Winglets
- Aircraft Windows
- Lightning Strikes
- Cabin Doors
- Cabin Air
- Mobile Devices
- Oxygen Masks
- Engine Failure
- Fuel Dumping
- Aircraft Structure and Materials
- Fatigue in the Cockpit
- Autonomous Flight

The report has to be written in English based on German or international standards on report writing.

Content

| | Seite |
|--|-----------|
| Content..... | 5 |
| List of Figures | 7 |
| List of Tables..... | 9 |
| List of Symbols | 10 |
| List of Abbreviations..... | 12 |
| List of Terms | 13 |
| 1 Introduction | 14 |
| 1.1 Motivation and Objectives | 14 |
| 1.2 Definition of Terms | 15 |
| 1.3 Literature | 16 |
| 1.4 Structure of the Paper | 16 |
| 2 Aerodynamics: Lift..... | 18 |
| 2.1 Bernoulli cannot adequately explain the Lift | 19 |
| 2.2 The Principle of Air Force..... | 21 |
| 2.3 A Sufficiently Correct Approach | 22 |
| 3 Aerodynamics: Winglets | 27 |
| 3.1 Aerodynamic Fundamentals..... | 27 |
| 3.2 Examination of the Wing with Winglet | 29 |
| 3.3 Winglets vs. Wingspan Enlargement | 36 |
| 4 Aircraft: Windows..... | 39 |
| 4.1 The Shape | 39 |
| 4.2 The Hole in the Cabin Windows | 42 |
| 5 Aircraft: Faraday Cage..... | 43 |
| 6 Aircraft: Doors | 45 |
| 7 Aircraft: Flight Mode..... | 48 |
| 8 Cabin: Oxygenmasks | 49 |
| 8.1 Emergency: Pressure Drop | 49 |
| 8.2 The Functionality of Oxygenmasks | 50 |
| 9 Cabin: Air | 52 |
| 9.1 From Bleed Air to Breathing Air | 52 |
| 9.2 Engine Oil..... | 55 |
| 9.3 Countermeasures | 55 |

| | | |
|-----------|--|-----|
| 10 | Scenario: Engine Failure | 57 |
| 10.1 | Extended-range Twin-engine Operational Performance Standards (ETOPS) | 57 |
| 10.2 | Emergency in Cruising Flight | 58 |
| 10.3 | Emergency at Departure | 58 |
| 10.4 | Two-sided Engine Failure | 59 |
| 11 | Scenario: Fuel Dumping | 60 |
| 12 | Aircraft Structure | 63 |
| 12.1 | Fiber-reinforced composites in aircraft construction | 64 |
| 12.2 | Back to the Future: Aluminium..... | 68 |
| 13 | Cockpit: Fatigue | 72 |
| 13.1 | Facts and Figures..... | 72 |
| 13.2 | Real Problems and Supposed Measures | 76 |
| 14 | Autonomous Flight | 79 |
| 14.1 | The Autopilot | 79 |
| 14.2 | Definitions | 82 |
| 14.3 | Regulations..... | 83 |
| 14.4 | Technical Feasibility | 84 |
| 14.5 | Most Frequent Causes of Accidents in Regular Flights | 84 |
| 14.6 | Safety..... | 84 |
| 14.7 | Passenger's Perception | 85 |
| 14.8 | Costs – An Estimation..... | 85 |
| 14.9 | Bottom Line..... | 86 |
| 15 | Summary | 877 |
| 16 | Outlook | 888 |
| | List of References | 89 |

List of Figures

| | | |
|--------------------|--|----|
| Figure 2.1 | Simplified sketch of the airflow around an airfoil | 19 |
| Figure 2.2 | Real flow around a wing (Babinsky 2005) | 20 |
| Figure 2.3 | Sketch of a streaming curved (top) and uncurved (bottom) paper..... | 20 |
| Figure 2.4 | Simplified sketch displaying the deflection of air particles by an airfoil ... | 21 |
| Figure 2.5 | Simplified dependency between lift and angle of attack | 22 |
| Figure 2.6 | Visualization of a fluid particle..... | 22 |
| Figure 2.7 | Illustration of an along a streamline accelerated fluid particle | 23 |
| Figure 2.8 | Schematically illustrated connection between pressure and distance on the streamline | 23 |
| Figure 2.9 | Illustration of an along a curved streamline flowing fluid particle..... | 24 |
| Figure 2.10 | Real flow around a wing (Babinsky 2005) | 24 |
| Figure 2.11 | Sketch: flow around an airfoil..... | 25 |
| Figure 3.1 | Wake vortices caused by pressurization (based on Eberle 1997)..... | 27 |
| Figure 3.2 | Ideal elliptical lift distribution with constant downwash | 28 |
| Figure 3.3 | Lift distribution over wing span white: without winglet, yellow: with winglet (Kaempf 2013) | 30 |
| Figure 3.4 | Forces acting on the winglet (simplified) | 30 |
| Figure 3.5 | Moment curve plotted over span winglet: blue, no winglet: green..... | 31 |
| Figure 3.6 | Estimation of parameters on underlying real conditions (Scholz 2012)..... | 33 |
| Figure 3.7 | Simple geometric drawing of the span enlargement by winglets (Scholz 2012) | 34 |
| Figure 3.8 | Sample values for k_{WL} (Scholz 2012)..... | 34 |
| Figure 3.9 | Diagram of the relative drag reduction and efficiency of winglets for some aircraft types (Scholz 2012) | 35 |
| Figure 3.10 | Lift distribution over span not extended: green, extended wing: yellow.... | 36 |
| Figure 3.11 | Moment distribution over span not extended: green, extended wing: yellow | 36 |
| Figure 4.1 | Fragment of the fuselage of Flight BA781 with the fuselage roof windows (based on Science Museum London 2009)..... | 39 |
| Figure 4.2 | Schematically represented stress curve over the cross-section of a sample subjected to tensile loading Tensile force F , σ_N : nominal stress, σ_k : notch stress (based on Neuber 1937) | 40 |
| Figure 4.3 | FEM visualized stress increases depending on the notch shape (Scherrer 2004) | 40 |
| Figure 4.4 | Simplified illustration of the force flow in a rectangular (left) and round (right) hole | 41 |
| Figure 4.5 | Stress increase as a function of the distance between the two stress concentrations (Scherrer 2004) | 41 |
| Figure 6.1 | Exaggerated illustration of the extent of a pressurized cabin with increasing height (Stefan 1966)..... | 45 |
| Figure 8.1 | Dependence of pressure on height (displayed in logarithmic form)..... | 49 |

| | | |
|--------------------|--|----|
| Figure 8.2 | All maneuvers of the British Boeing 787-800 graphically summarized (BFU 2012) | 51 |
| Figure 9.1 | Graphic: Inner life of an engine (Scholz 2017) | 53 |
| Figure 9.2 | Processes in the compressor of the engine (Scholz 2017) | 53 |
| Figure 9.3 | Temperature control of the cabin air (Scholz 2017) | 54 |
| Figure 9.4 | Engine oil from Exxon (Scholz 2017) | 55 |
| Figure 10.1 | Comparison between ETOPS and Non-ETOPS flights (based on FAA 2007) | 57 |
| Figure 11.1 | FUEL-Page on the ECAM of an A380 before a jetting operation (De Cespigny 2012) | 61 |
| Figure 12.1 | Entry of the FRP into load-bearing structures of commercial aircraft (based on Rieke 2013) | 65 |
| Figure 12.2 | Mass distribution of a typical medium- and long-haul aircraft in relation to the manufacturer's empty masses | 65 |
| Figure 12.3 | Mechanical characteristics for Airware 2050 sheets of different thicknesses (Constellium 2017) | 69 |
| Figure 12.4 | Comparison of the properties of Airware 2050 with a conventional aluminium-copper plate of 75mm thickness (Constellium 2017)..... | 69 |
| Figure 12.5 | 3D printed holder for the A350 XWB (Schmidt 2016) | 70 |
| Figure 13.1 | Departures and flight hours from 1970 to 2005 (Niederl 2007) | 72 |
| Figure 13.2 | Pilots' opinions on the main problems of flight duty time regulation (based on VC 2011)..... | 76 |
| Figure 14.1 | Rotation axes and control surfaces (Harris 2007)..... | 80 |
| Figure 14.2 | Functional principle of the loops | 81 |

List of Tables

| | | |
|-------------------|--|----|
| Table 3.1 | Comparison of the advantages and disadvantages of winglets | 31 |
| Table 3.2 | Aerodrome Reference Code (ICAO 1990-2007)..... | 38 |
| Table 14.2 | Evaluation matrix: autonomous flight | 86 |

List of Symbols

| | |
|------|----------------------------------|
| A | Aspect Ratio |
| a | Acceleration |
| b | Wing Span |
| C | Coefficient (Drag, Lift, Moment) |
| D | Drag (Force) |
| d | Diameter |
| E | Glide Ratio |
| e | Oswaldfactor |
| F | Force |
| FL | Flight Level |
| g | Earth Acceleration |
| h | Height |
| k | Factor |
| L | Lift (Force) |
| l | Length |
| M | Bending Moment |
| M | Mach Number |
| m | Mass |
| p | Pressure |
| R | Radius |
| r | Radius |
| s | Streamline |
| th | Thickness |
| v | Velocity |
| x | Coordinate |
| y | Coordinate |

Greek Symbols

| | |
|---------------|--------------------|
| α | Angle |
| Δ | Delta (Difference) |
| ε | Glide Ratio |
| γ | Glide Angle |
| ρ | Density |
| σ | Stress |

Indices

| | |
|------|----------------|
| ATM | Atmosphere |
| D | Drag |
| Di | Induced Drag |
| D0 | Zero-Lift Drag |
| eff | Effective |
| F | Fuselage |
| K | Notch |
| L | Lift |
| M | Moment |
| max | Maximum |
| N | Nominal |
| res | Resulting |
| st | Static |
| theo | Theory |
| tot | Total |
| WL | Winglet |

List of Abbreviations

| | |
|--------|--|
| ALM | Additive Layer Manufacturing |
| AP | Autopilot |
| APU | Auxiliary Power Unit |
| ATC | Air Traffic Control |
| BFU | Federal Bureau of Aircraft Accident Investigation |
| CFRP | Carbon Fiber-reinforced Plastic |
| CSSU | Civil Safety and Security Unit |
| DFS | German Air Traffic Control |
| DLR | German Aerospace Center |
| DIN | German Institute for Standardization |
| EASA | European Aviation Safety Academy |
| ECG | Electrocardiogram |
| EEG | Electroencephalography |
| EOG | Electrooculogram |
| ETOPS | Extended-range Twin-engine Operational Performance Standards |
| FAA | Federal Aviation Administration |
| FAR | Federal Aviation Regulations |
| FD | Flight Director |
| FEM | Finite Element Method |
| FL | Flight Level |
| FRP | Fiber-reinforced Plastic |
| ICAO | International Civil Aviation Organization |
| IT | Information Technology |
| LBA | German Federal Aviation Authority |
| JAR | Joint Aviation Requirements |
| MEW | Manufacturer's Empty Weight |
| MLW | Maximum Landing Weight |
| MTOW | Maximum Take-off Weight |
| NASA | National Aeronautics and Space Administration |
| NDT | Non-destructive Testing |
| NHTSA | National Highway Traffic Safety Administration |
| Pan Am | Pan American World Airways |
| SUST | Swiss Accident Investigation Board |
| TCP | Tricresyl Phosphate |
| TUC | Time of Useful Consciousness |
| WOCL | Window Of Circadian Low |

List of Terms

Lift

Dynamic lift is a key figure in fluid mechanics. It is the proportion of the force acting on a body flowed around, which is perpendicular to the direction of flow. The development of lift by inflow is explained by the fluid dynamics methodology. Uplift occurs when the air flows around suitably shaped bodies, e.g. wings. Here the air is redirected downwards, i.e. accelerated. The downward force on the air corresponds as counter force to the upward force on the wing, the lift. Lifting forces can also act in the direction of the ground and are then referred to as *downwash*. (Anderson 2001).

Drag

Drag is the physical figure that describes the force in fluid dynamics that opposes the fluid as a medium to a movement. A body moving relative to a gaseous or liquid medium experiences a flow drag, a force acting against the relative velocity. On the surface of a flowing body the flow causes locally different shear stress and pressure (*normal stress*). If pressure and shear stress are integrated over the entire surface, the resulting force that the flow exerts on the body is obtained. This force has a certain direction in space. The force component in the direction of flow is the drag force. (Anderson 2001).

Pressure Cabin

In the aerospace industry, a pressurized cabin is a pressure-resistant design of passenger cabin, cockpit and cargo hold for aircraft or spaceships flying at higher altitudes that enables people and animals to stay in life-threatening conditions. This is achieved by maintaining an increased air pressure in the pressurized cabin compared to the environment. A pressurized cabin requires a considerably higher design effort. The cabin pressure must be extensively regulated in order to avoid underpressure or overpressure in the cabin. (Brain 2011).

Fatigue

Fatigue is defined as significant tiredness, exhausted reserves of energy or an increased need for rest, disproportionate to all recent activities. Physical fatigue is the transient inability of a muscles to maintain optimal physical performance, and is made more severe by intense physical exercise. Mental fatigue is a transient decrease in maximal cognitive performance resulting from prolonged periods of cognitive activity. (Hawley 1997).

1 Introduction

1.1 Motivation and Objectives

Flying has become a matter of course for many people, making aviation closer than ever before. However, even today there is still a lot of cluelessness when it comes to very specific things in aviation. However, not only a lack of knowledge, but also fundamental misconceptions are common. Although almost everyone has flown before, others even fly regularly, there is hardly anyone who questions the characteristics of aviation. Procedures during the flight fascinate people, conditions and operation of the aircraft stimulate the curiosity, and yet very few people know neither processes before and after the flight, the physics of flying, the work of airlines and pilots nor the functionality of the cabin. Nowadays, efforts are being made to make the passenger's flight as comfortable as possible, including direct transfer from the airport gate over the gate bridge to the cabin seat. Sometimes the passenger does not even see the aircraft from the outside during this process. Fuelling the aircraft, loading the cargo hold, the push-back vehicle, the faces of the pilots and the work of air traffic controllers are things that passengers only notice in exceptional cases. The lack of information on aviation is a not insignificant trigger for rumours, superficial knowledge and false assumptions. This paper is intended to clean up all of this. In the following, many, but not all, features of passenger aviation are taken up, their truthfulness checked, broken down and assessed. The reader should get a sufficiently comprehensive insight into aviation, get to know the aircraft cabin better and become familiar with other peculiarities of both the flight and the aircraft. The individual points are largely inspired by the article "The 31 biggest secrets of air travel", which was published in the Telegraph on 9th September 2017. This deals with 31 particularities of commercial aviation which are unknown to most passengers. However, each topic was worked out independently of the publications of the aforementioned magazine, so that the mentioned article only contributed to the selection of some topics, but not their elaboration. The present draft provides a fundamental understanding of aviation. Among other things, it breaks down the principle of lift and the effect of winglets on wings on the basis of basic physical conditions, examines fundamentally different scenarios from fuel discharge processes to pressure drop in the cabin to engine failures and finally takes a look at the future of autonomous flights.

1.2 Definition of Terms

Aviation

Aviation is the transport of persons or goods through the earth's atmosphere without connection to the earth's surface. The term covers all persons, companies, activities and subareas (including on the ground) relating to the operation of aircraft. There are several categories within aviation. The two most important ones are civil and military aviation. Civil aviation, in turn, is divided into commercial and general aviation. Commercial aviation is regular, public and commercial air traffic or charter and occasional traffic. General aviation includes private air sports, commercial business flights but also flights with a sovereign mandate, for example those of the police or air rescue. On the other hand, military aviation concerns only flight operations with military aircraft or for military purposes.

Aircraft

An aircraft is a plane that is heavier than air and generates the dynamic lift required for its flight with non-rotating lifting surfaces. The International Civil Aviation Organization defines the term aircraft in ICAO (2017, pp.1-2) as follows:

“Aeroplane. A power-driven heavier-than-air aircraft, deriving its lift in flight chiefly from aerodynamic reactions on surfaces which remain fixed under given conditions of flight.”

In other words, when a legal text refers to aircraft, it only refers to motor planes, but not to gliders, motor gliders and microlight aircraft. In airplanes the lift - during the forward movement of the aircraft - is generated by deflecting the necessary airflow on the wings (with a suitable airfoil and angle of attack). Traditionally, an aircraft is divided into three main groups: airframe, engine and equipment.

Curiosity

Curiosity is something different from the ordinary. It therefore not only describes a characteristic of an object that is rather unusual, but also includes the desire to learn or know about anything.

1.3 Literature

The certain bullet points are mainly chosen independently from each other. Some points within the report have been taken from the online published article of the Telegraph (2017) "The 31 biggest secrets of air travel" and analysed in an expanded form inspired by it. This article is a summary of various publications written by various authors, which however remain untouched and unmentioned in this project work.

The paper is also highly influenced through the lecture notes and various other publications by Scholz (Scholz 2012, Scholz 2017, Scholz 2018). Especially in the topics winglets and cabin air Scholz is intensely referenced to as literature.

In the field of pilot fatigue, the association cockpit (VC 2011) and German Aerospace Center (DLR 2008) provide important evidence that can be confirmed among others by Caldwell's analyses (Caldwell 2004, Caldwell 20012).

Not least, the report by Wensorra and Roennebeck (Wensorra 2018) from the HAW-Hamburg made an important contribution to the field of autonomous flying.

Further literature that has had a profound influence on the creation of this report are indicated in the appropriate passages.

1.4 Structure of the Paper

The paper deals with 13 topics. The main part of this document contains explanations of the following:

- Chapter 2** critically examines prevailing attempts to explain the phenomenon of lift and finally explains lift with sufficient accuracy.
- Chapter 3** evaluates the attachment of winglets to aircraft wings, provides a comparison with an equivalent span enlargement and shows an estimation method for the modified Oswald-factor.
- Chapter 4** takes a look at the construction of aircraft windows. Of particular interest is the shape of these and the small hole in them.
- Chapter 5** explains the fuselage structure as a Faraday cage.

- Chapter 6** questions whether a door can be opened during the flight and uses an example calculation to do so.
- Chapter 7** takes up the well-known myth of the flight-mode of mobile devices and reviews it for validity.
- Chapter 8** investigates the functionality of oxygen masks. An example will also show how concerned the passenger should be about the limited oxygen capacity.
- Chapter 9** is about the newly discovered fact that cabin air is toxic to a health-critical level. Furthermore, consequences and measures are mentioned.
- Chapter 10** deals with the horror scenario of an engine failure. The main question is to what extent such an engine failure poses danger to passengers.
- Chapter 11** informs about the process, the consequences and the alternatives of fuel dumping.
- Chapter 12** provides an insight into the structure of aircraft. However, even goes one step further and analyzes potential future materials.
- Chapter 13** provides well-founded knowledge about the workload of pilots and the resulting fatigue in the cockpits of passenger jets.
- Chapter 13** opens the discussion on autonomous flying. On the basis of some simple thinking paths, it even dares to judge the potential of autonomous flying in the conclusion.

Since there is usually no connection between the individual sections, they are subject to their own structure, which is built considering the best explanation path. Mostly, this is achieved by dividing the section into further subsections.

2 Aerodynamics: Lift

The fact that aircraft with their structural weight weighing several tons and the cargo on board can take off still concerns the general public as well as science. The key word here is *lift*. It is a term that makes sense to everyone and with which everyone justifies the flying of airworthy devices - but what is lift in the first place and what causes it?

The answer to this question seems to be as banal as it was clarified by a number of books decades ago. The Wright brothers took advantage of the phenomenon as early as the 19th century when they glided through the air with self-designed aircraft and later undertook a controlled flight with an airplane powered by an engine. Otto Lilienthal probably made the biggest sacrifice in order to investigate the uplift on the basis of the flight principle "heavier than air", namely his own life after a fall from 15 m height. Many resources are still used today for researching this phenomenon, with a special focus on the optimization of wings in order to generate the maximum lift that can be achieved in practice. But it is all the more frightening that in the currently supposed enlightenment there is still a lot of ambiguity and incomprehension, not only in the ranks of the general public, but also in science and literature. Sadly, it is difficult to find a plausible explanation that correctly explains the causes and effects of the uplift. Apart from the lack of correct explanations, the scientific ranks and, to a particularly high degree, the general public is even characterized by false attempts at explanation.

These supposedly correct explanations I would like to take up below and check for plausibility and finally dare an own test, which based on basic physical knowledge explains the lift at airplane wings.

So, the issue of lift has not been resolved to the extent we expect. NASA and Boeing engineer Philippe Spalart, who made a major contribution to aerodynamics with the Spalart-Allmarasmodel¹, described the problem with these words:

„It's easy to explain how a rocket works, but explaining how a wing works takes a rocket scientist.”²

¹ The Spalart-Allmaras model describes the movement of a turbulent flow with regard to its viscosity. It is used in aviation in the case of a wall-bound flow and could prove itself in its application with regard to the results.

² The quote was taken from a lecture by Doug McLean entitled "Common Misconceptions in Aerodynamics"

2.1 Bernoulli Cannot Adequately Explain the Lift

I would like to start with the most widely used theory, which is based on the Bernoulli effect. Simplifying, an incompressible fluid is assumed. Since the *Bernoulli Equation* can be seen in Section 2.3, a detailed derivation is not supposed to be included here. The Bernoulli Equation states that the specific energy of the fluid particles is constant along a streamline in the stationary flow of viscosity-free and incompressible fluids. From this it can be concluded that the pressure is always constant along a streamline.

$$p_{tot} = p_{st} + \frac{\rho}{2}v^2 + \rho gh \quad (2.1)$$

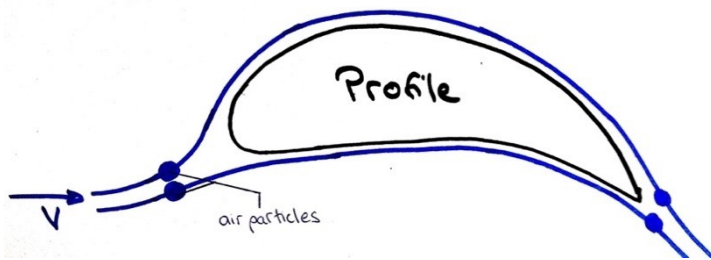

Figure 2.1 Simplified sketch of the airflow around an airfoil

If we now imagine two air particles with finite dimensions, Figure 2.1 shows their travelled distance along their respective streamline. At the airfoil nose, the two particles separate from each other, flow up and down along the airfoil and, according to the theory, finally come together again at the end of the airfoil at the same time. The airfoil is curved and has a certain airfoil thickness, so it is easy to understand that the distance the particle travels at the top is greater than the distance at the bottom curve of the airfoil. It is now concluded that the particle flows at the top with higher speed than the lower one, since it has to cover more distance in the same time. This is where Bernoulli comes in. This states that high kinetic energy causes high dynamic pressure. However, because the total pressure is unchanged, the static pressure is reduced. This means that due to the high speed of the particles above and the comparatively low velocity of the particles below, immediately below the airfoil a high-pressure area and above the wing a low-pressure area prevails. The sum of all pressures acting on a surface results in a force, the lift force, which is always perpendicular to the direction of flow.

Well, the theory sounds plausible at first, yet it confuses cause and effect. Basically, the theory correctly states, lift can only be produced by pressure difference and even classifies high and low-pressure areas locally correctly. In its search for the cause of the different pressure areas, it uses velocity because, as Bernoulli proved, it significantly determines static pressure. The theory thus claims that speed is the decisive physical variable that makes lift possible. However, the reason for the higher particle velocity above the airfoil is based on completely wrong assumptions. In fact, it is fundamentally wrong that the particles meet again at the end

of the airfoil at the same time and thus the causality of the higher fluid velocity above the airfoil is completely due.

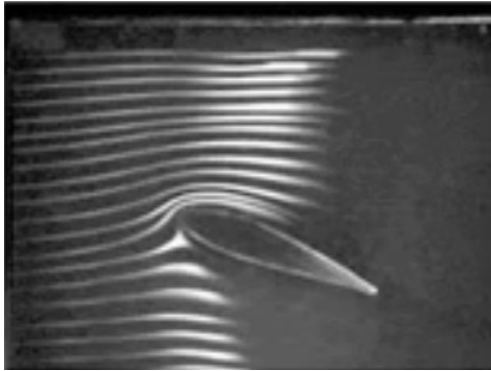

Figure 2.2 Real flow around a wing (Babinsky 2005)

Nevertheless, wind tunnel images like Figure 2.2 show that the fluid above the airfoil does indeed flow faster, even much faster than the theory assumes.

The theory presented here can therefore be rejected. Although it recognizes the connection between pressure difference and lift, it cannot explain why the high velocity, which in turn is wrongly assumed to be the decisive cause of the pressure difference.

The following simple experiment proves that the speed is not the decisive variable that generates lift:

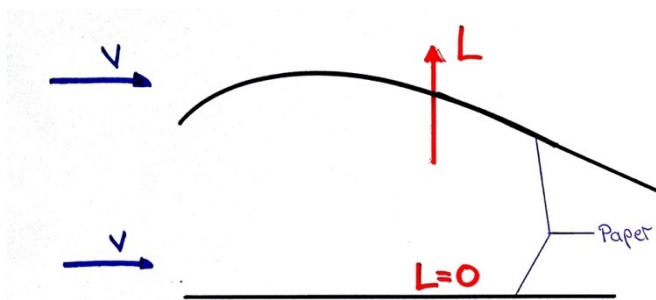

Figure 2.3 Sketch of a streaming curved (top) and uncurved (bottom) paper

By blowing over the top of a curved paper as shown in Figure 2.3 in the first attempt, you notice that the paper deflects upwards. In the second pass, a straight piece of paper is blown along the top. Although in both cases the particle velocity above the paper is greater than below, the uncurved paper does not deflect. So, one can conclude, instead of speed, curvature is decisive for lift.

2.2 The Principle of Air Force

Another, admittedly not widespread, approach to explain the flying of an aircraft is based on the air force generated by the inflow, which pushes the wing upwards. The principle is simple and intuitively understandable.

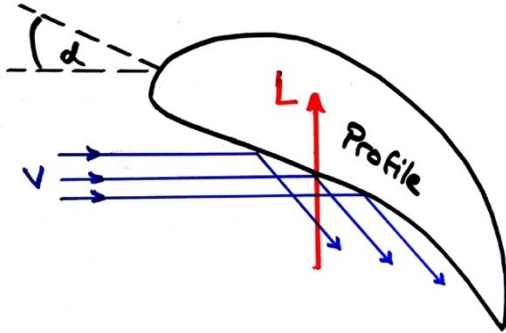

Figure 2.4 Simplified sketch displaying the deflection of air particles by an airfoil

We can imagine the inflowing air in the form of countless air particles that hit the airfoil at high speed. On impact, these are deflected with the underside of the airfoil, i.e. they experience a downward force. According to the third Newton law, the particles then exert a force on the airfoil that is equal in amount and opposite in its direction. This reactionary force of air onto the airfoil is accordingly the lift force pushing the airfoil upwards.

This approach is basically correct, because in reality indeed the air exerts a force pushing the wing upwards. However, the latter lacks many unconsidered connections.

First, one determines that here the pressure difference caused by curvature remains completely unconsidered as the decisive cause. In reality, the lift is primarily caused by this. The force that the air particles exert on the wing exists, but its dimension is far too small to lift an aircraft. It is also noticeable that the particles only press the wing upwards as long as it has an angle of attack α . However, investigations showed that there is lift on a wing, even though the angle of attack is $\alpha \leq 0^\circ$. Figure 2.5 shows the latter schematically.

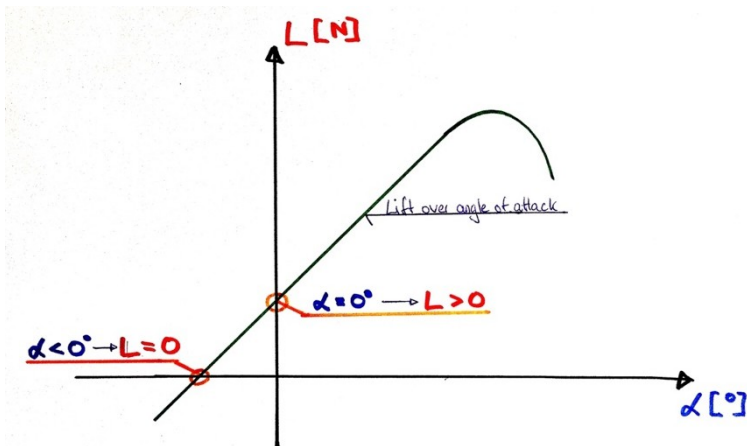

Figure 2.5 Simplified dependency between lift and angle of attack

So even that attempt at explanation cannot satisfactorily explain the upswing.

In the following, a sufficiently complete approach should explain the lift, which is first developed with the help of physical principles.

2.3 A Sufficiently Correct Approach

First of all, simplifications are made. Since air has a low mass and a low coefficient of friction, gravitational forces and frictional forces are neglected. An incompressible flow is also assumed. Figure 2.6 shows an unaccelerated infinitesimal small air particle in space with the pressure forces acting on it.

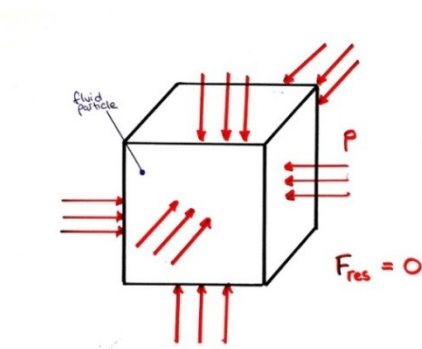

Figure 2.6 Visualization of a fluid particle under pressure on all sides

In the case of an unaccelerated particle, all compressive forces are just equal in amount, so that the resulting force F_{res} acting on the particle is zero. However, if the pressure varies, the particle experiences a force, then an acceleration.

In the next step, a particle flowing on its streamline at velocity v is observed (Figure 2.7). In this case we assume that the particle becomes faster from left to right, i.e. it experiences a positive acceleration.

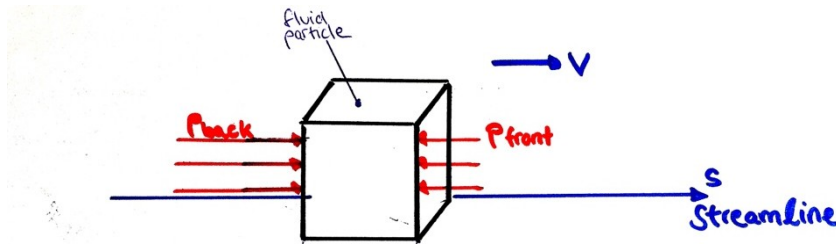

Figure 2.7 Illustration of an along a streamline accelerated fluid particle

Newton's second law explains the relationship between acceleration and force as follows:

$$F = m \cdot a \quad (2.2)$$

So, if the particle is accelerated, this means in reverse that a force F acts on it. The accelerating force F is just the sum of the compressive forces p_{back} and p_{front} .

Consequently: $p_{\text{front}} < p_{\text{back}}$.

This leads to the following conclusion:

- pressure increases along streamline \rightarrow speed decreases
- pressure drops along streamline \rightarrow speed increases

So, there is a direct dependence between speed and pressure. This relationship is defined by the Bernoulli Equation (2.1.1). It can be seen that the Bernoulli effect is easy to understand with Newton's second law. The latter can be displayed schematically for the fluid particles under consideration.

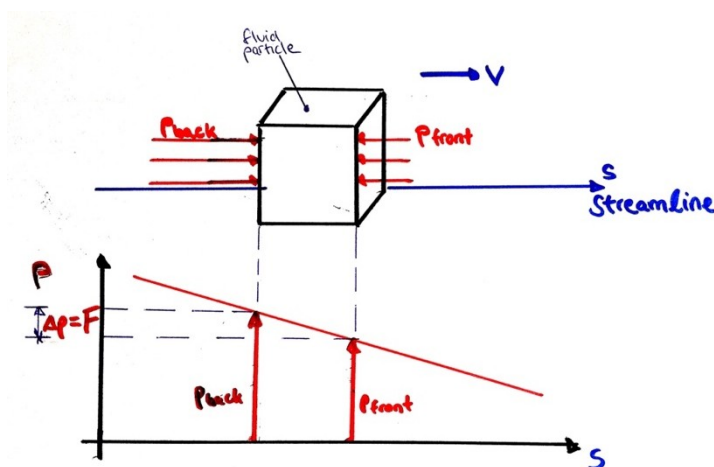

Figure 2.8 Schematically illustrated connection between pressure and distance on the streamline

Now a fluid particle is to be observed on a curved streamline.

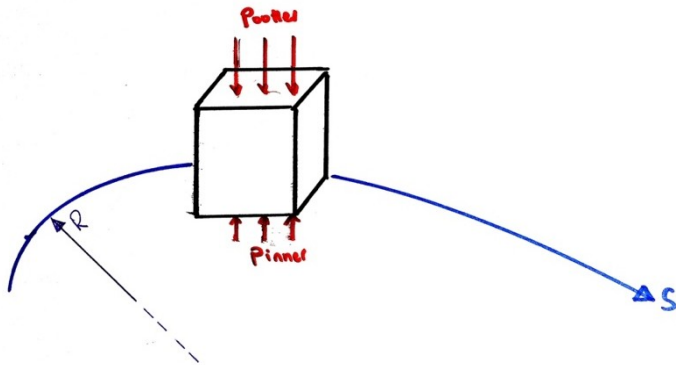

Figure 2.9 Illustration of an along a curved streamline flowing fluid particle

Assuming that the particle is unaccelerated in the horizontal direction, it is valid:

$$p_{front} + p_{back} = 0$$

In order for the particle to flow along its curved path, however, there must be an acceleration that keeps it on the downward curved path. We are talking about *centripetal acceleration*. This centripetal acceleration or force, which always acts towards the centre of curvature, can be explained by the fact that the pressure p_{outter} acting on the particle from above is greater than p_{inner} . According to this, it is:

$$p_{outter} + p_{inner} \neq 0$$

The key discovery with which lift can be understood is accordingly:

The total pressure decreases in the direction of the center of curvature

In the next step, the phenomenon of lift will be represented by means of an airfoil.

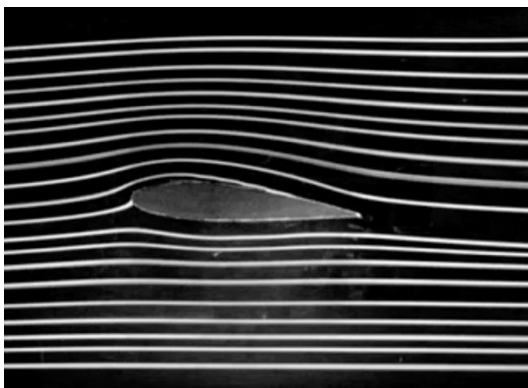

Figure 2.10 Real flow around a wing (Babinsky 2005)

Figure 2.10 shows a snapshot of a flowed wing in a wind tunnel. The facts can be reduced to a sketch in order to draw easy conclusions from the one below.

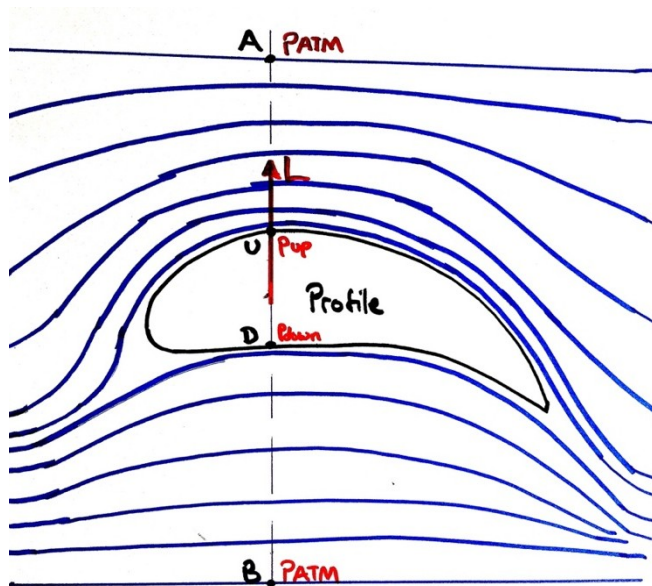

Figure 2.11 Sketch: flow around an airfoil

Figure 2.11 shows that the atmospheric pressure p_{ATM} prevails far enough above and below the wing at points A and B and p_{up} and p_{down} at points U and D immediately above and below the wing. The streamlines above are curved downwards. Since the pressure decreases in the direction of the center of the streamlines, as already derived, a lower pressure p_{up} prevails at point U than at point A with the pressure p_{ATM} . Immediately above the wing there is therefore a low-pressure area. The streamlines below the wing also show a slight downward curvature. So, the pressure decreases downwards. Point B is closer to the centre of curvature than point D, so p_{down} is larger than p_{ATM} and thus the area below the wing is a high-pressure area. It is concluded:

$$p_{up} < p_{ATM} \text{ and } p_{down} > p_{ATM}$$

therefore:

$$L = p_{up} + p_{down} \quad (2.3)$$

with

$$p_{up} < p_{down}$$

In this way, the wing is pushed upwards by the lift force L .

The greater the angle of attack and the curvature of the airfoil, the greater the lift, because both variables determine the pressure area. In practice, this is challenging for engineers because a larger radius of curvature in turn results in a lower centripetal force which, as we know, holds the particles along the airfoil contour. If the centripetal force is not sufficiently high, the flow is disrupted. This is the so-called *stall*, in which the lift value drops abruptly. In real flight, the occurrence of a stall can have devastating consequences.

So, it becomes clear, trivial explanations do not do sufficient justice to the appearance of lift. Lift must be understood as an extremely complex cause of flying, and as such it must be optimized with a high degree of sensitivity from an engineering point of view.

The development of the explanation for lift was deliberately not made via the path of circulation and the starting vortex, etc., since this quantity is rather suitable for calculating various phenomena and is difficult to understand.

3 Aerodynamics: Winglets

Winglets or *sharklets* are mostly vertically mounted, extended outer wings at the ends of the wings of aircraft. They provide better lateral stability, reduce induced drag and thus improve the glide angle and climb rate at low speed (Schlichting 2001).

As in almost all commercial sectors, aviation is also concerned with reducing operating costs. Fuel consumption plays an important role in times of rising kerosene prices. The engineers' final intention when attaching winglets to wings is to save fuel by reducing induced drag.

But how efficient are winglets overall and can't the same efficiency be achieved by extending the wing span equivalently?

At this stage it is important to understand some basics.

3.1 Aerodynamic Fundamentals

Induced Drag

The drag of an aircraft can be divided into individual components. One of these is the so-called *induced drag*. The wing generates lift when the air flows in and deflects the inflowing fluid particles downwards as a result; this is referred to as *downwash*. During this process, the horizontal component of the velocity of the particles is reduced, thus causing a resistance force. However, the aforesaid force due to drag is only a part of the induced drag. The other, often smaller part results from the pressure pressurization at the wing ends (Anderson 2001). As it is well known, there is a relative under-pressure area in flight above the wing and underneath a relative over-pressure area. Due to a balancing flow of the particles from the high to the low-pressure area, counter-rotating boundary vortices, also called *wake vortices* (Figure 3.1) are formed at the ends of the wing, which make no contribution to the lift, even reduce it.

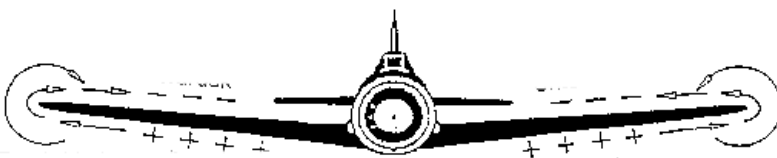

Figure 3.1 Wake vortices caused by pressurization (based on Eberle 1997)

Contrary to what is often assumed, the induced drag of aircraft does not only occur at the wing ends, but at the entire wing (McLean 2005).

The induced drag is added to the surface drag and the pressure drag to form the total drag. However, the friction drag can be neglected due to the small order of magnitude, so that the total drag coefficient C_D results in:

$$C_D = C_{D0} + C_{Di} \quad (3.1)$$

The coefficient of induced drag applies to

$$C_{Di} = \frac{C_L^2}{\pi A} \quad (3.2)$$

However, this only applies to the ideal case of an elliptical uplift distribution! Such an ideal elliptical lift distribution, in which the downwash is a constant value, can be displayed schematically as follows:

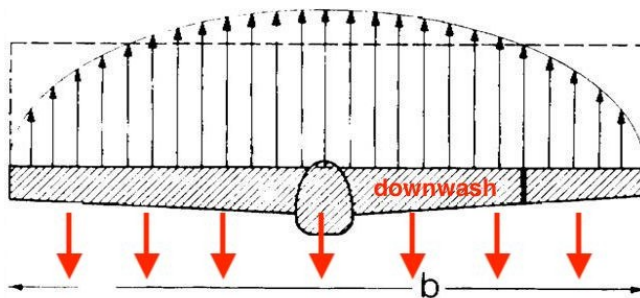

Figure 3.2 Ideal elliptical lift distribution with constant downwash

Oswald Factor e

The Oswald factor is also referred to as wing efficiency or span efficiency. It can be regarded as a form efficiency factor and can practically never reach the value 1. The higher the Oswald factor, the better the geometry of the wing. In the ideal case of the ellipse, the Oswald factor is one. It is usually in the range of 0.6 to 0.9. Taking the Oswald factor into account, the coefficient of the induced drag then results to:

$$C_{Di} = \frac{C_L^2}{\pi A e} \quad (3.3)$$

3.2 Examination of the Wing with Winglet

Mayer (2007, pp.34-35) concludes:

„Der einfachste Weg zur Reduktion des induzierten Widerstandes ist die Verlängerung der Tragfläche eines Flugzeuges ...“ „Praktisch wird so durch zusätzliche Spannweite mehr Auftrieb erzeugt. Wie bereits gezeigt, entsteht durch den induzierten Widerstand und den damit verbundenen Randwirbel eine Abnahme des Auftriebs in Richtung Flügelende, welche massiv von der theoretischen elliptischen Auftriebsverteilung abweicht. Das Ziel ist es also, entweder den Wirbel zu reduzieren und so den Einfluss auf die Auftriebsverteilung zu minimieren, oder durch mehr Tragfläche und somit mehr Auftrieb, den Verlust an Auftrieb durch den induzierten Widerstand zu kompensieren. Die Lösung des Problems ist das Winglet ...“³

The winglet contributes to the splitting of the original vortex and at the same time acts as a barrier to maintain the lift distribution of the wing. Detailed calculations can be made on the basis of the *Trefftz-plane* theory (Kroo 2007). It can be gathered from these that the induced drag can be reduced by increasing the vertical height of the uplift system and extending its span. According to the theory, the box-wing constellation provides the smallest induced drag.

The aerodynamic effects of the winglets are summarized as follows:

- Wake vortices are broken down
- Shifting of the vortex and occurrence at the tip of the winglets
- Smaller vortex
 - lower rotational speed and kinetic energy
 - less kinetic energy is withdrawn from the system
- The smaller loss of kinetic energy is reflected in the reduced induced drag

The following schematically visualized lift distribution over the wingspan of the wing results:

³

Translation by the author:

The simplest way to reduce induced drag is to extend the wing area of an aircraft In practice, more lift is generated by an additional span. As already shown, the induced drag and the associated vortices cause a decrease of lift towards the wingtip, which deviates massively from the theoretically elliptical lift distribution. So, the goal is either to reduce the vortex and thus minimize the influence on the lift distribution, or to compensate the loss of lift due to induced drag by more bearing surface and thus more lift. The solution to the problem is the winglet...

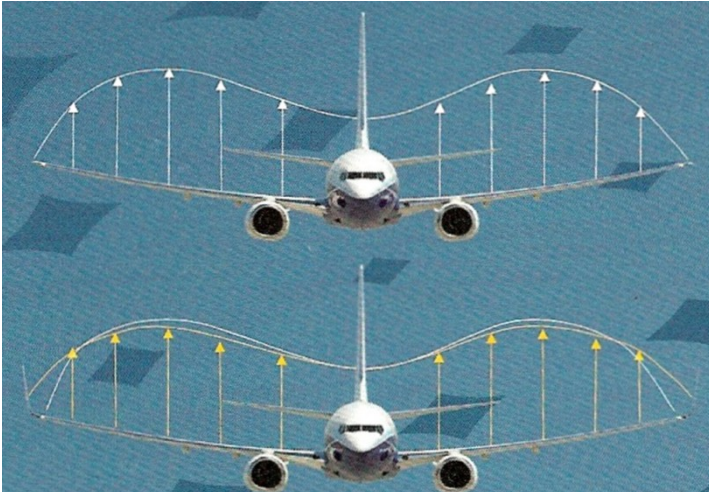

Figure 3.3 Lift distribution over wing span [white: without winglet, yellow: with winglet] (Kaempf 2013)

Of course, the winglet changes the lift distribution. Lift no longer reaches zero at the wingtip, but at the end of the vertical winglet (Figure 3.3). Under the same conditions, the wing with winglets thus generates a higher lift value through more wing area. Strictly speaking, the winglet generates more lift at the end of the wing, which has a positive effect on the lateral stability of the aircraft. Furthermore, the induced drag is reduced, which in combination with the increased lift leads to a significantly improved *glide ratio* ("L over D").

The additional lateral force and the additional lever arm increase the bending moment by a constant summand.

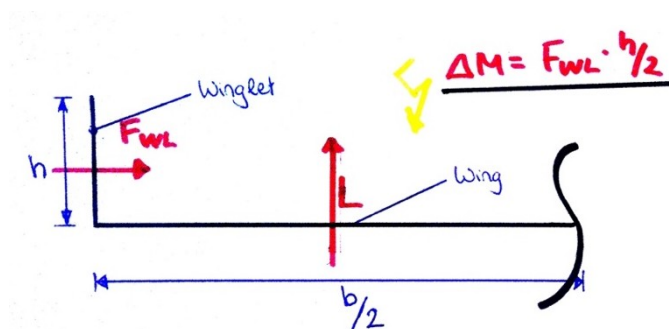

Figure 3.4 Forces acting on the winglet (simplified)

To illustrate the moment curve, it is more vivid to apply the span of the winglet and the wing on the same axis.

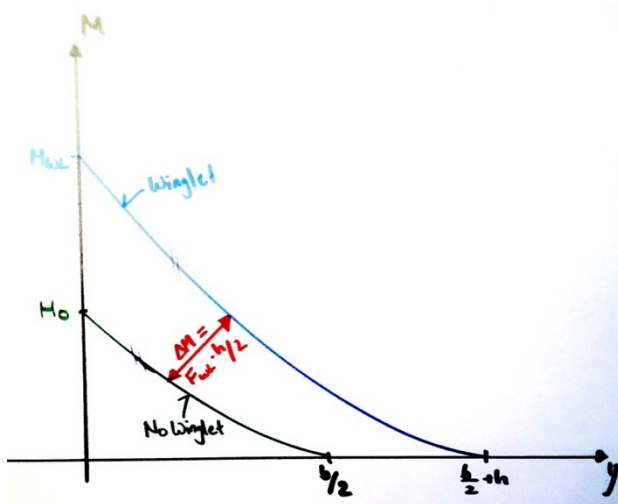

Figure 3.5 Moment curve plotted over span [winglet: blue, no winglet: green]

It can be seen that the bending moment at any point of the wing is greater than before and an additional axial load occurs.

Advantages and Disadvantages of Winglets in Real Flight Operations

In a nutshell, the following aspects of winglets can be mentioned in practice:

Table 3.1 Comparison of the advantages and disadvantages of winglets

| Advantages | Disadvantages |
|---|--|
| <ul style="list-style-type: none"> • reduction of wake vortices <ul style="list-style-type: none"> ○ greater take-off and landing frequency ○ better use of airports • lower kerosene consumption <ul style="list-style-type: none"> ○ longer range ○ higher maximum payload • higher ceiling height <ul style="list-style-type: none"> ○ more efficient work of the engines ○ lower engine maintenance costs • shorter take-off distances <ul style="list-style-type: none"> ○ reduced noise emissions • higher climb speeds • improved flight and flow characteristics <ul style="list-style-type: none"> ○ shift of the point of a stall • modern and aesthetic design | <ul style="list-style-type: none"> • Zero lift drag increases • Aircraft weight increases <ul style="list-style-type: none"> ○ by winglet mass ○ additional axial force ○ danger of flutter increases • Landings with crosswind made more difficult • Additional costs for aircraft manufacturers and airlines |

Influence of Winglets on the Oswald Factor

For an elliptical circulation distribution, the Oswald factor $e = 1$ can be set. Real wings practically never reach that value, with or without winglet. The Oswald factor can be understood as a form-efficiency factor. We could conclude from considerations above that winglets have a positive effect on the lift distribution, increasing the shape efficiency of the wing. Scholz (2012) succeeded in estimating the Oswald factor sufficiently precisely in the phase of pre-designing the wing on the basis of fewer geometric parameters. The following explanations and visualizations are taken from the aforementioned report.

In general, the following relationship applies to non-planar (NP) wing constellation:

$$e_{NP} = e \cdot k_{e,NP} \quad (3.4)$$

The Oswald factor e is corrected using $k_{e,NP}$. In case of the winglet (WL) it is:

$$k_{e,NP} = k_{e,WL}$$

and

$$e = e_{theo} k_{e,F} k_{e,D0} k_{e,M} \quad , \quad (3.5)$$

so that the Winglet-Oswald factor results in:

$$e_{WL} = e_{theo} k_{e,F} k_{e,D0} k_{e,M} k_{e,WL} \quad (3.6)$$

Thereby the factors are:

- e_{theo} the theoretical Oswald factor
- $k_{e,F}$ the correction factor for loss caused by the fuselage
- $k_{e,D0}$ the correction factor for viscous drag by lift
- $k_{e,M}$ the correction factor for compressibility effects

These can of course be calculated or estimated using the Scholz' and Nita's method. For the parameter $k_{e,D0}$, Scholz provides the following list from which the respective value can be taken.

| Aircraft category | d_F / b | $k_{e,F}$ | k_{e,D_0} |
|-------------------|-----------|-----------|-------------|
| All | 0.114 | 0.974 | - |
| Jet | 0.116 | 0.973 | 0.873 |
| Business Jet | 0.120 | 0.971 | 0.864 |
| Turboprop | 0.102 | 0.979 | 0.804 |
| General Aviation | 0.119 | 0.971 | 0.804 |

Figure 3.6 Estimation of parameters on underlying real conditions (Scholz 2012)

The remaining values can be estimated by inserting geometry values as follows:

$$k_{e,F} = 1 - 2 \left(\frac{d_F}{b} \right)^2 \quad (3.7)$$

$$k_{e,M} = a_e \left(\frac{M}{M_{comp}} - 1 \right)^{b_e} + c_e \quad (3.8)$$

with

$$a_e < 0 \quad ; \quad c_e = 1$$

The resulting values are:

$$\begin{aligned} a_e &= -0,00152 \\ b_e &= 10,82 \\ c_e &= 1 \\ M_{comp} &= 0,3 \end{aligned}$$

The parameter e_{theo} is developed on the basis of the equation of Hoerner (1965). The latter is represented by a function and linearized. The derivation of the equation is dispensed with. After shifting the function by $\Delta\lambda$ according to the NASA minimum it results to:

$$e_{theo} = \frac{1}{1+f(\lambda-\Delta\lambda)A} \quad , \quad (3.9)$$

with

$$\Delta\lambda = -0,357 + 0,45e^{-0,0357\varphi_{25}} \quad , \quad (3.10)$$

and

$$f(\lambda - \Delta\lambda) = 0,0524(\lambda - \Delta\lambda)^4 - 0,15(\lambda - \Delta\lambda)^3 + 0,1659(\lambda - \Delta\lambda)^2 - 0,0706(\lambda - \Delta\lambda) + 0,0119 \quad (3.11)$$

The Oswald factor e_{WL} influenced by a winglet is calculated as:

$$e_{WL} = k_{e,WL}e = \left(\frac{A_{eff}}{A}\right)e = \left(\frac{b_{eff}}{b}\right)^2 e = \left(1 + \frac{2h}{b}\right)^2 e \quad (3.12)$$

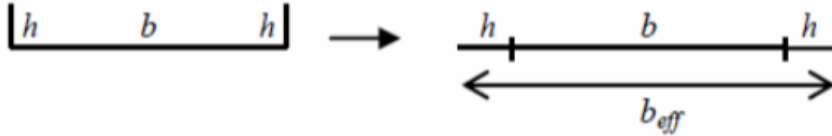

Figure 3.7 Simple geometric drawing of the span enlargement by winglets (Scholz 2012)

However, the geometry by which the efficiency factor $k_{e,WL}$ was developed as a result of winglets is very simplified as per Figure 3.7, which results in a deviating value. The error is corrected by the correction factor $k_{WL} > 1$. According to literature, different values may apply to the latter. Assuming that the winglet with its height h delivers exactly the same effect as a wing extension of the same length, $k_{WL} = 1$ is valid, but since this is not the case in reality, a different winglet-ratio k_{WL} must be used. Consequently, the above correction is made on $k_{e,WL}$:

$$k_{e,WL} = \left(1 + \frac{2}{k_{WL}} \frac{h}{b}\right)^2 = \frac{A_{eff}}{A} = \left(\frac{b_{eff}}{b}\right)^2, \quad (3.13)$$

Deviating correction factors k_{WL} are observed for real wings. Some examples are shown in Figure 3.8.

| Approach / Source | Reference | k_{WL} |
|--------------------------|--------------------------|----------|
| Geometry | - | 1.00 |
| Howe | Howe 2000 | 2.00 |
| Kroo | Kroo 2005 | 2.13 |
| Whitcomb | Whitcomb 1976 | 2.20 |
| Dubs, Zimmer | Dubs 1975, Müller 2003 | 2.45 |
| Real aircraft average | Boeing 2002, Airbus 2012 | 2.83 |
| 767-400 raked tip | Boeing 2002 | 1.58 |
| 747-400 tip plus winglet | Boeing 2002 | 2.92 |
| 737-800 blended winglet | Boeing 2002 | 3.08 |
| KC-135 winglet | Boeing 2002 | 2.65 |
| MD-11 extended winglet | Boeing 2002 | 3.62 |
| A320 NEO | Airbus 2012 | 3.29 |

Figure 3.8 Sample values for k_{WL} (Scholz 2012)

The insertion of all determined values into the equations shown finally provides an estimated value for the Oswald factor. With this method, much can be said about the respective Oswald factor, the induced drag and the lift as well as about the flight behaviour even before the air-

craft is designed. No aerodynamic, structural or other parameters are necessary to get a sufficiently accurate idea of the efficiency of the wing.

Efficiency of Winglets

In an in-depth essay by Scholz (2018) on winglets he introduces the term "Intrinsic Aerodynamic Efficiency of Winglets" and defines it simply as such:

$$\text{Intrinsic Aerodynamic Efficiency} = 1/k_{WL}$$

The aim is to compare the efficiency of the winglet $1/k_{WL}$ with the relative drag decrease $|\Delta D/D|$. For this Scholz calculates the respective values within the scope of his paper and displays them graphically.

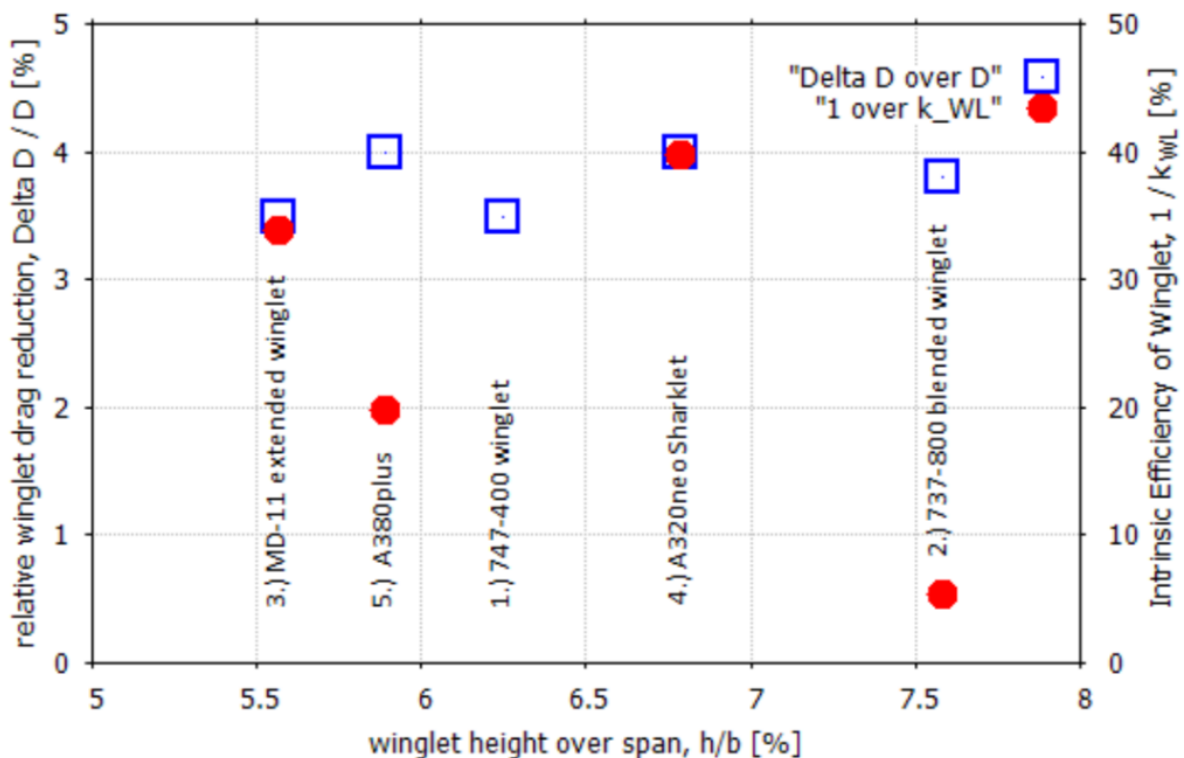

Figure 3.9 Diagram of the relative drag reduction and efficiency of winglets for some aircraft types (Scholz 2012)

Scholz (2018) proceeds in such a way that in order to obtain the pure winglet effect, in his calculations of efficiency $1/k_{WL}$ he eliminates the effect of the span enlargement (which always applies to winglets). Its aim is therefore to indicate the efficiency of winglets with $1/k_{WL}$, regardless of their aerodynamic effects due to horizontal wing extension.

It can be seen that all types considered show a similar reduction in drag of 3.8% on average (Figure 3.9). However, winglets for aircraft types vary in efficiency, the value varies greatly depending on the type. The efficiency of the winglets on the B747 drops below zero. In other

words: The aircraft would be better off not having winglets at all. All other aircraft show a positive efficiency less than one. This means their winglets are beneficial, but a horizontal wing extension would be better for all aircraft.

3.3 Winglets vs. Wingspan Enlargement

Finally, a wing with a span-widened extension is to be considered additionally and compared with the pure winglet wing. The lift and moment distribution with a "longer" wing are then self-explanatory and simplified below.

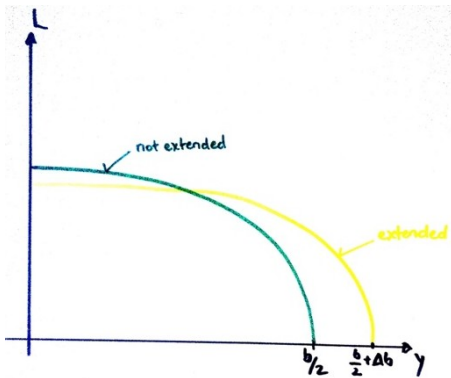

Figure 3.10 Lift distribution over span
not extended: green, extended wing: yellow

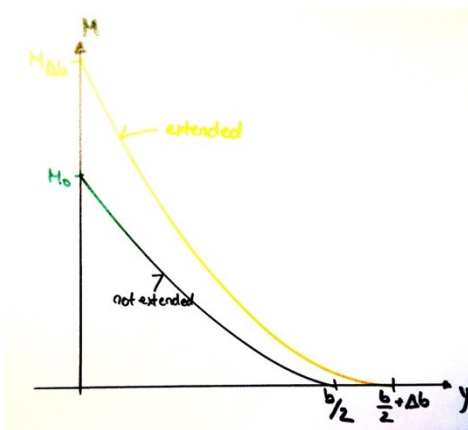

Figure 3.11 Moment distribution over span [not extended: green, extended wing: yellow]

Both variants have a higher lift and a reduced induced drag compared to the basic wing under the same conditions, resulting in a higher glide ratio $E = L/D$. The bending moment at the root of the wing with winglet is lower compared to the extended wing. This is so because the winglet is less efficient than the wing extension. For the same reduction in induced drag, the bending moment would be the same. However, in the winglet wing a part stresses the wing

structure in the form of an axial load, however the axial loads on the wing do not dimension the wing. Both, winglets and span extension, result in weight gain, which in turn increases overall drag due to the necessity of increased lift.

In literature there are also comparisons between winglets and the wingspan extension. Some authors, who tried to develop rules of thumb in the form of a ratio of winglet height to length-equivalent span extensions, at which both achieve the same efficiency, should be mentioned here. A ratio of 2 must be interpreted in such a way that the winglet must be twice as long as the span extension in order to have the same effect. In this case k_{WL} would be 2 and the "Intrinsic Aerodynamic Efficiency of the Winglets" would be 0.5.

Larson 2001:

Same drag reduction at half of the mass and a winglet ratio of 1.5.

Jones 1980:

Same drag reduction with the same mass and a winglet ratio of 1.5.

McLean 2005:

Same drag reduction with same mass and a winglet ratio of 2.

McLean's rule of thumb is very close to reality.

The decisive reason why winglets are still preferred to an equivalent span extension in reality is the manoeuvrability of the aircraft at the airport. Horizontal extensions of the wings would require more space at airports, which is not available in practice.

Furthermore, aircraft models are approved according to certain classes. If the wingspan of the aircraft exceeds the permitted wingspan for the respective class, the aircraft would not qualify for daily use.

Table 3.2 Aerodrome Reference Code (ICAO 1990)

| Code Letter | Wingspan |
|-------------|----------------|
| A | < 15 m |
| B | 15 m to < 24 m |
| C | 24 m to < 36 m |
| D | 36 m to < 52 m |
| E | 52 m to < 65 m |
| F | 65 m to < 80 m |

4 Aircraft: Windows

4.1 The Shape

The type de Havilland DH-106 Comet 1 was the first mass-produced jetliner in the world. About five years after the plane's first flight, a plane of the same type crashed near the island of Elba in the Mediterranean Sea (Nelson 1993, p.20). All 35 passengers of British-Overseas-Airways-Corporation flight BA781 lost their lives. After the wreckage was found, extensive and long-lasting investigations were carried out. The tests showed that the accident was caused by loss of the pressurized cabin. As probably already known, an artificially maintained overpressure is generated in the cabin at great heights. The pressure drop was caused by a weak spot in a window. The smallest cracks that had led to material fatigue could be detected under the microscope. In response to the incident, the airline carried out necessary conversions on the de Havilland DH-106 Comet 1, including the adjustment of the windows from a rectangular to an oval shape.

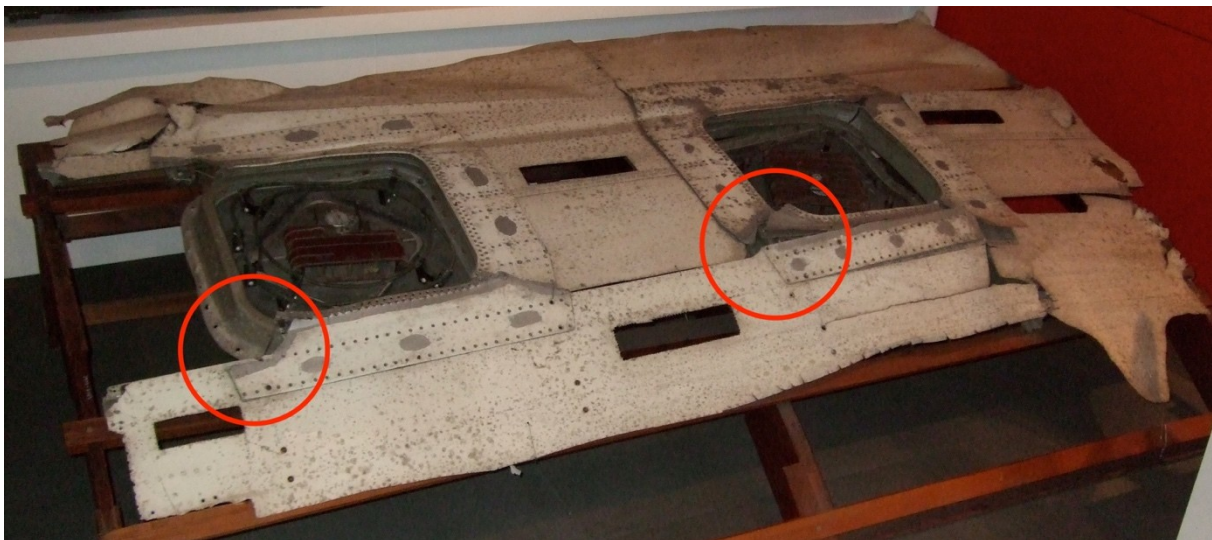

Figure 4.1 Fragment of the fuselage of Flight BA781 with the fuselage roof windows (based on Science Museum London 2009)

This case gives reason to investigate the shape of aircraft windows. Due to the high pressure inside the cabin, the fuselage structure is always subjected to tension in the circumferential direction. An airplane window is generally nothing more than a hole in the structure. This hole causes the structure to be exposed to higher loads at this point. This is known as the *notch effect*.

Notch Effect

The notching effect is described by two factors:

- The local *stress concentration*, often called stress increase.

- The *support effect*. This refers to the fact that the material and the present decay method of the stress concentration counteract the stress peaks.

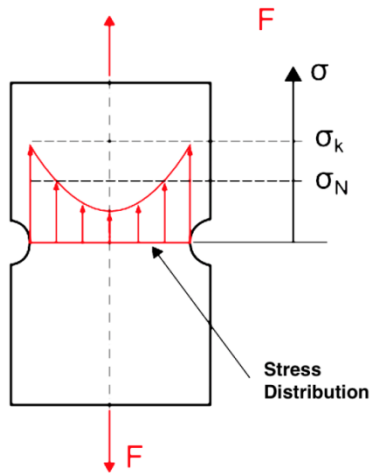

Figure 4.2 Schematically represented stress curve over the cross-section of a sample subjected to tensile loading [Tensile force F , σ_N : nominal stress, σ_k : notch stress] (based on Neuber 1937)

A higher stress is found in the immediate proximity of the notches than at a great distance from them (Figure 4.2); this is referred to as *stress peaks* caused by the notching effect (Neuber 1937). A rectangular airplane window would have four corners, which in turn always had a notch effect on the structure. The stress increases would be immensely high at the corners of the window (Figure 4.3).

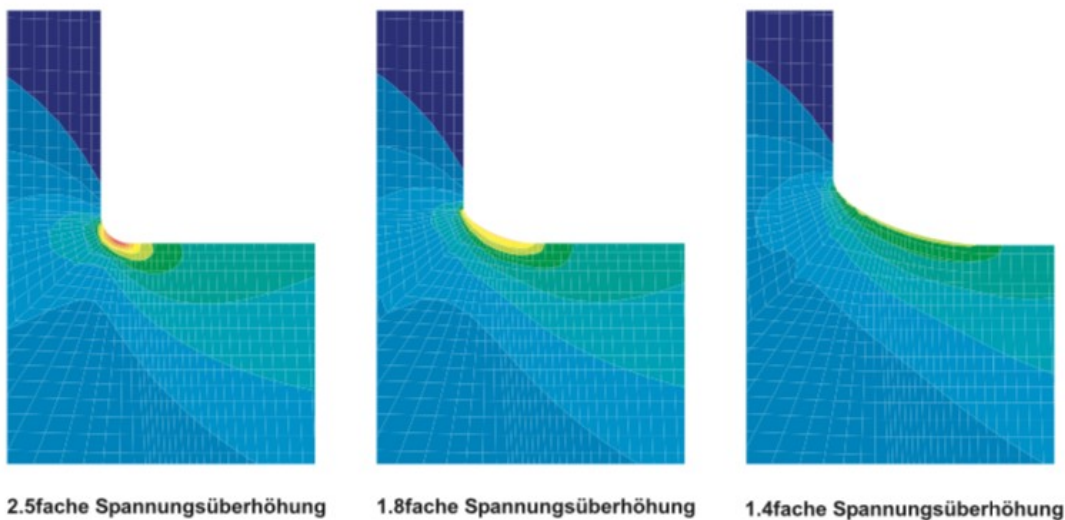

Figure 4.3 FEM visualized stress increases depending on the notch shape (Scherrer 2004)

The rounder the corner is, the smaller stress peaks occur at the workpiece. These increased stresses are caused by the "stagnation" of the force flow at this point. Stress peaks can therefore be reduced not only by optimizing the notch shape, but also by diverting the force flow correspondingly (Figure 4.4).

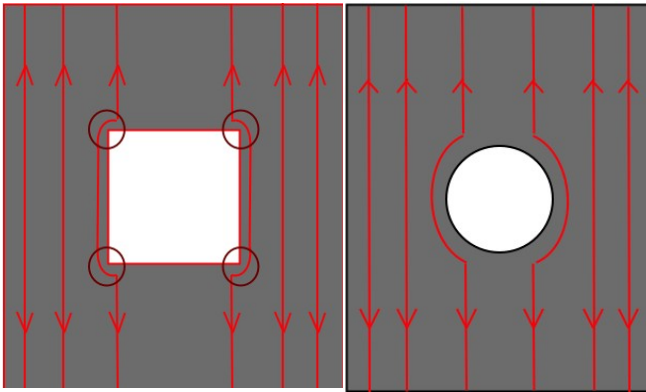

Figure 4.4 Simplified illustration of the force flow in a rectangular (left) and round (right) hole

A round window therefore weakens the hull structure not only less because of missing corners, but also diverts the force flow more favourably, so that the stress increases reach smaller values than with a rectangular window. Increased stress concentrations place an overly high load on the structure, which can fatigue the material at these points and cause cracks that can spread extremely quickly, as the case of flight BA781 shows. Especially with a high pressure difference between the cabin and the atmosphere, this can result in the demolition of entire structural parts from the fuselage.

With the new Dreamliner B787, the aircraft manufacturer Boeing relies on a mechanically optimized shape of round cabin windows.

These are "long-stretched" oval-shaped high-tech windows with the same shape as long holes. The effect Boeing would like to make use of in this context falls under the principle of *notch stress separation* (Scherrer 2004, pp.54-55). The spatial separation of notch stresses is not an optimization due to adaptation of the shape. Nevertheless, it is an extremely simple process for reducing notch stresses. The increase in stress that occurs with slotted holes is considerably smaller than with round holes.

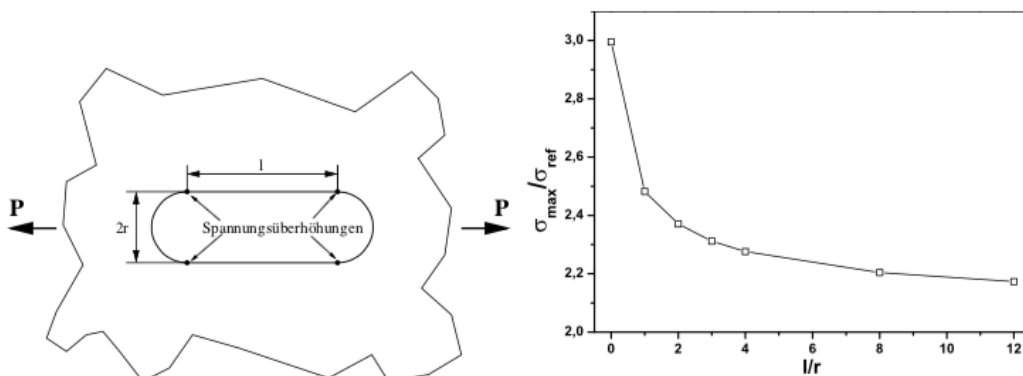

Figure 4.5 Stress increase as a function of the distance between the two stress concentrations (Scherrer 2004)

σ_{\max} is the maximum stress occurring near the notch and σ_{ref} is the reference stress, in this case the gross stress of the component. The quotient of the mentioned stresses results in the factor of the stress rise. It is noticeable that even a small extension of the circular hole leads to a significantly reduced stress increase. The latter then approaches asymptotically to the value 2 with ever larger extensions.

4.2 The Hole in the Cabin Windows

The attentive passenger may have noticed that every window in the aircraft consists of several layers of glass and always has a small hole. The spearing of the windows has another physical cause.

In general, an aircraft window consists of three glasses, an outer, middle and inner glass. Only the exterior is connected to the fuselage structure and can be exposed to high stresses, among other things due to the higher load-bearing capacity of its material. The middle and inner screens are embedded into the inside wall of the aircraft by means of plastic seals. Due to the pressure difference between cabin interior and atmosphere, all components of the cabin interior wall are highly stressed. The outer and middle glasses cannot bear the high-pressure load, which is why pressure equilibrium must be created between the air space between the inner and middle as well as the air space between the middle and outer glasses (called *air gap*). The latter is done by drilling a hole in the middle glass. The hole then functions as a vent valve and also prevents humidity accumulation on the windows, so that the passenger has a clear view outside. The inner screen has no technical function. Usually this is a simple plexiglass cover of the window system to protect the passenger from the low temperatures of the other two screens. The hole keeps the air pressure between the middle and outer glasses in equilibrium, ensures that the pressure inside the cabin remains constant and protects the middle glass in an emergency. The hole in the airplane window is therefore not a defect, but it makes a lot of sense.

5 Aircraft: Faraday Cage

Areas with bad weather are no longer a problem these days, but still cause inconvenience and are therefore preferably avoided. Bad weather usually occurs below *cruise altitude*. If the pilots cannot avoid the bad weather front for undisclosed reasons, there is the danger of lightning strikes on the aircraft. In this case, the passengers perceive a bright light and a loud noise, shortly afterwards the voice of the captain, which indicates a lightning strike. Such an event is extremely rare from the point of view of the individual passenger, whereas an airliner is struck by lightning diverse times over its entire lifetime. The FAA has calculated that every aircraft in the country's entire fleet is struck by lightning at least once a year. More than one hit is also possible when a plane gets into a storm.

Airplanes are designed in such a way that they constitute "the path of least resistance" for lightning and then act as a kind of lightning conductor. The fuselage of the aircraft is nothing more than a *Faraday cage* without grounding, which is why lightning not only enters the aircraft but also exits towards the ground. The fuselage conducts the power around the aircraft cabin. A lightning strike therefore poses no danger to passengers and crew, and the aircraft can normally continue its journey without hindrance. Nevertheless, accurate and costly inspections are required after the flight.⁴

The Faraday cage is a closed shell consisting of an electrical conductor that shields the interior from the current flow. In the case of external static or quasi-static electric fields, the inner area remains field-free as a result of the influence. If lightning strikes a Faraday cage, people in the interior remain safe because the electric field strength in the interior is considerably lower than in the exterior.

Pan-Am-Flight 214

Although aircraft manufacturers strive to minimize the consequences of lightning strikes in the air, no aircraft is a perfect Faraday cage. For example, the lightning impulses from a loosely seated rivet in the wing can generate a spark, which in turn can cause the fuel in the tanks to explode. This also happened in 1963 with a Boeing 707 from Pan-Am (Pan Am 1963). On December 8, 1963, a Boeing 707-121 crashed on Pan-Am Flight 214 over the US state of Maryland after lightning struck the aircraft and caused the fuel gases in a wing tank to explode. All 81 passengers were killed in the accident. The debris from the left wing and the shortwave antenna torn off from the fin had numerous small, punctual craters in which the metal had melted. At outer section of left wing, lightning struck through cover completely, leaving about five millimeters hole in the surface (Gero 1994). The explosion occurred in the left reserve tank.

⁴ Based on the inspection procedure of Lufthansa Technik AG

In the same year, the Federal Aviation Administration (FAA) issued a series of binding regulations to avoid such an incident in the future.

However, the carbon fiber-reinforced composites used more and more frequently in aircraft construction also conduct electrical power far less efficiently than the aluminum used to date. Although these materials used in wings and tail units contain layers of electrically conductive material, it is sometimes the case that not all parts of an aircraft are in complete electrical contact with each other. In the worst, if rather unrealistic case, this can lead to a "jam" in the lightning flow, and the energy is then strong enough to tear a hole in the fuselage.

Nevertheless, lightning strikes are handled in a very controlled manner and the consequences are dealt with quickly. The high demands placed on the aircraft during certification leave little doubt that aircraft are adequately protected against lightning strikes, so there is no reason to worry.

6 Aircraft: Doors

The aircraft cabin is actually a *pressurized cabin*. At altitudes where atmospheric pressure does not allow human life, breathing within the aircraft must be guaranteed. This is achieved by maintaining the pressure inside the cabin at a certain level so that fresh air is supplied to the human respiratory tract. The air pressure in the cabin exceeds the ambient air pressure many times over, making the cabin a room of relative overpressure.

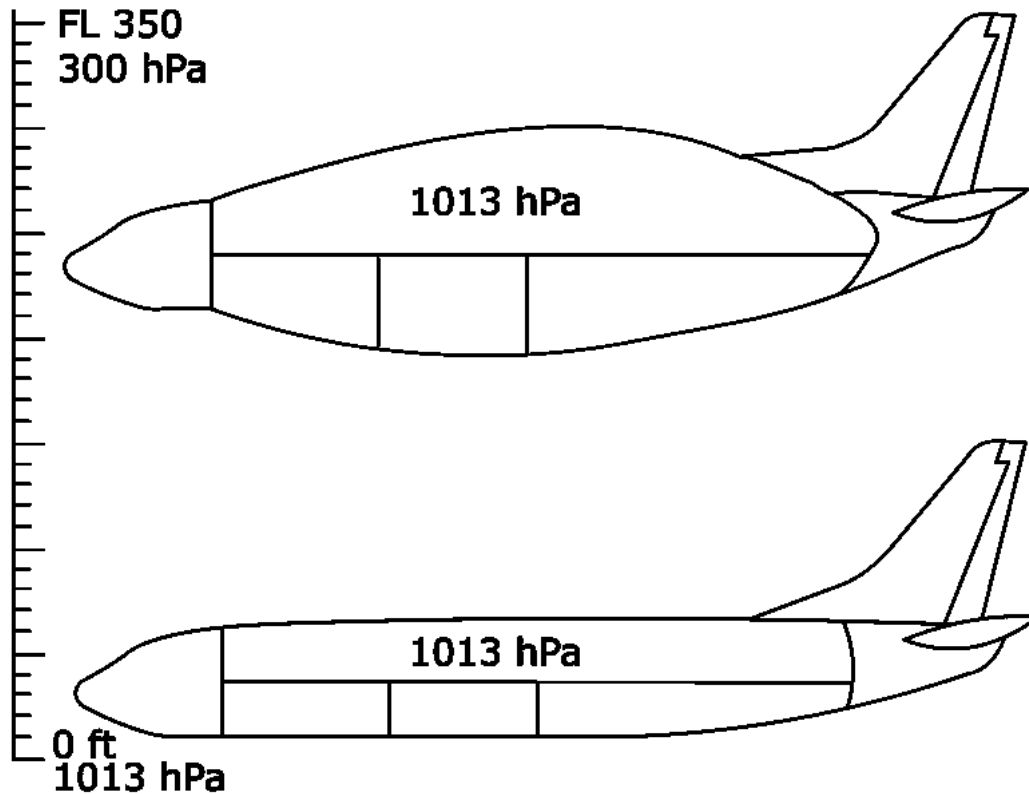

Figure 6.1 Exaggerated illustration of the extent of a pressurized cabin with increasing height (Stefan 1966)

In order to prevent the expansion of material and structure due to the high pressure, the hull structure is reinforced appropriately. In order to reduce weight, the structure is not reinforced at will, but only to a certain extent. In addition, the pressure difference (*differential pressure*) is reduced during the flight. The latter is achieved by adjusting the cabin pressure to the prevailing air pressure equivalent to an altitude up to 8000 ft (2400 m). Consequently, the cabin pressure can be printed out as the equivalent of a height, which is why it is often referred to as the *cabin height*. Figure 6.1 shows that the pressure conditions change considerably during a flight. Already at an altitude of 18000 ft (approx. 5450 m) the atmospheric pressure has halved from normal pressure at sea level (1013 hPa), at 34000 ft (approx. 10300 m) it is only one quarter.

The cabin pressure in modern aircraft is controlled by *outflow valves* and protected by *emergency valves*. Weak points of such a pressurized cabin are especially the aircraft doors, the aircraft windows and the *rear bulkhead*.

Gaps, e.g. in form of holes, lead to *decompression* of the cabin during flight at lower pressures, i.e. the relative overpressure in the cabin is eliminated by pressurization with the atmosphere. At altitudes above 10 000 ft, the human respiratory tract is not sufficiently supplied with oxygen and there is a risk of unconsciousness and, in the worst case, death. In addition, the pressurization creates a kind of "suction" that "pulls" any objects and persons in the immediate vicinity out of the aircraft. The smaller problem is that the temperature inside the cabin drops to a minimum. Consequently, opening the cabin door during the flight has predictably serious consequences for crew and passengers, but can be compensated in an emergency by a rapid descent.

So, how likely is such an incident? Not at all. Because the aircraft door cannot be opened at all during the flight. In general, a frame on the outer frame is provided for the door. When opening the door, the cabin crew must lift it slightly so that it has a certain angle to the longitudinal axis of the aircraft and engages in the frame provided for it. When the door is lifted, it moves inwards before finally opening in a swivelling movement by turning the lever outwards. During the flight there is a high-pressure area in the cabin as shown above compared to the surroundings of the aircraft, thus an immense pressure on the door, so that it cannot be lifted and opened by human hand in the first place. Aside from the multiple safety locks. It is estimated that there is a force of several tons on the door during cruising flight, making it impossible to open it. The Flug Revue (2007) provides the following simplified calculation example in the same wording:

„Die vordere Kabinentür einer Boeing B767 ist 1,07 Meter breit und 1,88 [Meter] hoch, das ergibt eine Fläche von fast genau zwei Quadratmetern. Auf Reiseflughöhe von 10 000 Metern hat die Außenluft nur noch einen sehr geringen Druck von ungefähr 0,3 bar. Das entspricht in etwa einem Drittel des Drucks auf Meereshöhe. Der Druck in der Kabine wird dagegen ... auf 0,8 bar erhöht, das entspricht dem Luftdruck auf ... 2000 [Metern] ... [Höhe]. Der Druckunterschied beträgt also gut 0,5 bar. Generell gilt: ... Druck entspricht ... Kraft pro Fläche. Die 0,5 bar lassen sich dann auch als 50 000 Newton pro einen Quadratmeter darstellen. Da die Tür der Boeing B767 aber eine Fläche von zwei Quadratmetern besitzt, wirkt also zweimal die Kraft von 50 000 Newton auf die Tür, das macht 100 000 Newton ... Demnach müsste man also mit einer Kraft von zehn Tonnen gegen die Tür drücken, um sie im Flug zu öffnen ...“⁵

⁵ Translation by the author: "The front cabin door of a Boeing B767 is 1.07 meters wide and 1.88 [meters] high, which gives an area of almost exactly two square meters. At cruising altitude of 10,000 metres, the outside air pressure is only about 0.3 bar. This corresponds to about a third of the pressure at sea level. The pressure in the cabin, on the other hand, is... 0.8 bar, which corresponds to the air pressure at ... 2000 [meters] ... [altitude]. The pressure difference is therefore ... 0.5 bar. Generally, it is valid: ... pressure is equal to ... force per area. The 0.5 bar can then also be represented as 50,000 Newton per one square meter. However, since the door of the Boeing B767 has an area of two square metres, the force of 50,000 Newton acts twice on the door, which makes 100,000 Newton ... So, you'd have to press against the door with a force of ten tons to open it in flight..."

In the absolutely unlikely event of an explosion that tears out an airplane window, for example, a suction to the outside is indeed created that is strong enough to transport objects and persons in the surrounding area into the stratosphere. The seatbelts are designed for these load cases, among other things. The force generated by the lost window is never large enough to release the passenger sitting at the window from the seat belt. In this case, too, aircraft are once again adequately equipped, and passengers are secured. The myth of the crazy passenger who opens the cabin door during the flight contradicts all basic physics and is thus refuted.

7 Aircraft: Flight Mode

Airplane mode is an operating mode of a mobile phone, tablet or other communication device in which all radio units of the device and thus the wireless communication functions are deactivated without switching off other device functions. As switched on wireless communication devices can influence other devices by radio waves, these must be switched off in aircraft or switched into flight mode. *Radio waves* are electromagnetic waves whose frequencies lie below 3000 GHz and can propagate in free space without artificial path. These include the long, medium, short and ultra-short wavelengths used for broadcasting, as well as radar and microwaves.

„Please make sure that electronic devices such as smartphones or tablets are turned off or in flight-mode.“

This or something similar sounds the announcement in every aircraft before take-off, calling on passengers to switch all devices to flight mode or to switch them off completely.

The myth that mobile phone radiation would directly influence aircraft and navigation systems is long gone, because it has been proven that a device that is not in flight-mode cannot hinder navigation or other systems. Nevertheless, there is a risk, albeit a very small one, that radio waves emitted by the device overlay and interfere with the radio waves of the board communication or frequencies of *air traffic control* (ATC). This would lead to a noise in the pilot's headphones, which in most cases does not endanger the work, but is perceived as disturbing by the pilots. These interference signals can occur especially when the user sits close to the cockpit. This is annoying for the pilots, but does not affect the safety on board.

Therefore, it is not risky to claim that the restriction of electronic devices during flight is much more a question of comfort than safety. Many passengers would simply feel disturbed by other guests' mobile phone or lap-top activities. Lufthansa spokesman Michael Lamberty told the *Tagesspiegel* (2014) that their customers have said very clearly in surveys that they felt disturbed by telephone calls in the airplane. So, this quiet zone should not be lost.

In this debate, the IT industry association Bitcom conducted a study in which one third of those questioned voted for the continuation of an absolute ban on the use of electronic devices in aircraft. Three years ago, yet, it was 55 per cent. On the other hand, in the current study about two thirds pleaded for restricted browsing and telephoning on board.

In 2014, the German Federal Aviation Authority (*Luftfahrtbundesamt*) approved the operation of mobile phones in aircraft in principle in implementation of amended guidelines of the *European Union and the European Aviation Safety Agency* (EASA). However, the airlines require a clearance certificate from the aircraft manufacturer confirming that the safe operation of the aircraft is not impaired by the operation of mobile equipment.

8 Cabin: Oxygenmasks

“In the unlikely event of a sudden loss of cabin pressure, oxygen masks will drop down from the panel above your head... Secure your own mask before helping others.”

Every passenger may have heard this sentence of the flight crew, some might even know it by heart. Airliners are equipped with *oxygen masks* above each seat and in the toilets, which are located in the cabin ceiling and automatically fall into the passengers' field of vision in the event of a drop in pressure.

8.1 Emergency: Pressure Drop

The sudden pressure drop in an aircraft with a pressurized cabin is the rapid drop in air pressure within the cabin. The cabin pressure is adjusted to the pressure outside the aircraft, which is determined by the current altitude. It represents an emergency situation because, depending on the flight altitude, there is an acute risk of suffocation for the board crew and passengers. Figure 8.1 shows the drop in air pressure as a function of altitude.

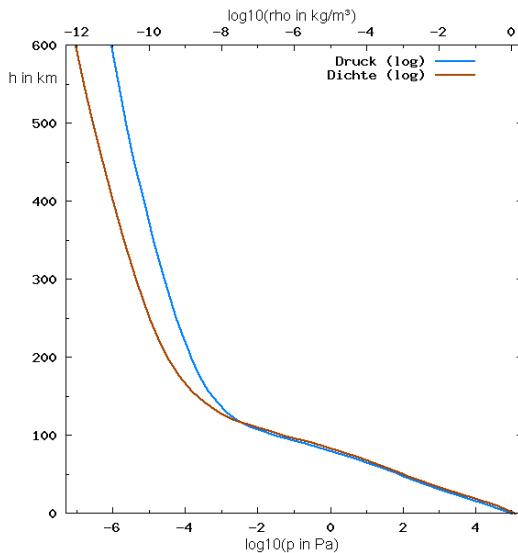

Figure 8.1 Dependence of pressure on height - displayed in logarithmic form

The technical construction of the pressurized cabin keeps the cabin interior under relative overpressure at altitudes where human survival is no longer possible due to the low air pressure. The pressure prevailing in the aircraft is, however, lower than the air pressure at sea level because the cabin is not designed for arbitrarily high pressure differences for weight reasons, and typically corresponds in a commercial aircraft to the air pressure prevailing at an altitude of approximately 2400 m or 8000 ft.

The time left to those affected to take meaningful action in the event of a pressure drop is called *time of useful consciousness* (TUC). This time is shortened depending on the altitude. For a flight level of FL250, i.e. 25000 ft, the TUC is given as 3 min to 5 min, for a flight level of FL350, however, only 30 s to 60 s (Hinkelbein 2007, p.78).

8.2 The Functionality of Oxygenmasks

Pulling the rip cord of the oxygen mask ignites the chemical oxygen generator and starts the production of oxygen. For weight reasons, this is not a pressure vessel from which oxygen flows. It is rather a chemical mixture, the combustion of which produces oxygen. This chemical oxygen generator is mounted directly above the masks under a cover and can supply almost 100 % pure oxygen gas for approximately 12 min. to 15 min. Since at an external pressure such as at 10 km altitude with normal breathing air of approx. 21% oxygen content unconsciousness occurs in approx. 15 seconds due to oxygen deficiency, every passenger who notices the masks falling off should immediately put on a mask and only then help neighbouring passengers and clarify the situation in their surroundings. The oxygen mask does not compensate the pressure drop in the cabin, but increases the partial pressure of oxygen under the mask. This enables the lungs to absorb sufficient oxygen even at low pressure.

In fact, there is only a limited amount of oxygen per passenger. But before assuming that "too little" oxygen is present in the generators, the following case study should be considered.

Is 12 minutes enough?

A practical example provides information:

During a passenger flight of a Boeing 737 from Bergamo (Italy) to East Midlands (Great Britain) a pressure loss occurred during the climb to cruising altitude in Swiss airspace. Following BFU 2012, the crew carried out an emergency descent and landed the aircraft at Frankfurt-Hahn Airport. 13 passengers were slightly injured. The investigation of the event was delegated by the Swiss Accident Investigation Board (SUST) to the Federal Bureau of Aircraft Accident Investigation (BFU 2012).

All processes are described sufficiently precisely by the diagram in Figure 8.2.

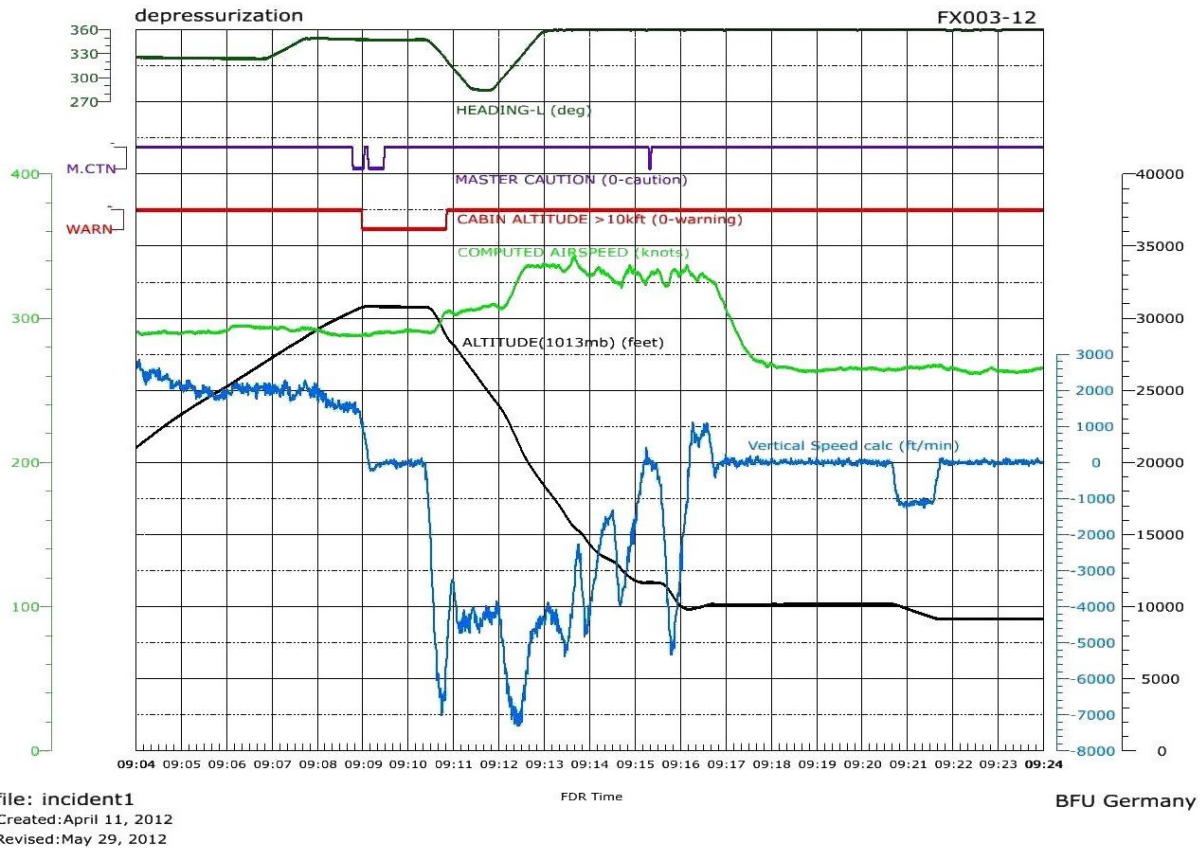

Figure 8.2 All maneuvers of the British Boeing 787-800 graphically summarized⁶ (BFU 2012)

The audio recordings available to the BFU show that the pilots become aware of the pressure loss in the cabin 13 minutes after take-off at 09:08:40 hrs. The altitude curve shows that the pilots start the descent from flight level FL308 at approx. 09:10:30 hrs and this is finished at approx. 09:16:30 hrs. The pilots reach with sink rates between 7000 ft/min and 4000 ft/min after 5 min the flight level FL100, in which the air pressure of the atmosphere is not misanthropic.

The case described shows that the oxygen supply limited to 12 minutes is generously designed. The pilots managed to solve the dangerous situation within about 8 minutes, whereby the descent could have been even faster. In consideration of the fact that an emergency descent to 10000 ft is possible within a few minutes due to an extremely fast but controlled descent of the aircraft, there is no reason to panic. The oxygen supply is therefore completely sufficient despite the supposedly short time of 12 minutes.

⁶ Based on the official report of the BFU [21] and taken from the same

9 Cabin: Air

"It was during the descent that my first officer told me he was feeling really bad and very close to vomiting. He went on to oxygen. I felt confused and five seconds later I, too, was close to vomiting. I just managed to put on my mask, after which I could hardly move. We were sitting there flying at 600 miles an hour, late at night, both of us more or less incapacitated. I could not even raise my hand; I could not talk; it was like I was paralysed."

These are the words of Neils Gomen, the captain of a Swedish aircraft, who later added that the 73 passengers on the plane were strangely asleep so deeply that it would have been difficult to wake them up, Starmer-Smith 2008.

The fact that cabin air can have a negative impact on health is not a novelty. But the death of British Airways pilot Richard Westgate in 2012 caught the attention of experts and critics. Dozens of pilots spoke out against the cabin air and warned the aircraft manufacturers not doing enough about it. But it was not until the death of the British pilot that the appropriate media attention and the open debate about the negligence of the manufacturers, the ignorance of the passengers and not infrequently of the crew as well as possible preventive measures took place. Medical specialists refer to the long-term consequences of inhalation of cabin air as the so-called *aerotoxic syndrome*.

In 2006, more than 1050 such incidents were recorded and - unlike in Germany - also published by the aviation authorities in the United Kingdom. In February 2009, Lufthansa acknowledged in an internal communication to its employees that one in 2000 flights would result in an oil vapour incident.

Respiratory distress, cardiac arrhythmia, headaches, abdominal cramps, muscle weakness, flu-like symptoms, impaired balance and numbness are a number of symptoms that can occur after a so-called *fume event*. All of them fall under the term aerotoxic syndrome. These symptoms may or may not occur immediately. They can also develop over days and weeks or stay away completely. It is caused by the absorption of heated toxic substances from lubricants and hydraulic fluids used in aircraft engines.

9.1 From Bleed Air to Breathing Air

Bleed air is compressed air taken from the combustion air stream compressed in the turbo compressor of gas turbines for various purposes. The bleed air is diverted before the air flow enters the combustion chamber. Aircraft engines, APUs or ground starters can be considered as suppliers of bleed air. Among other things, it is used for air conditioning and pressurization of the cabin in the *air conditioning packs*.

The bleed air system is identified as the main cause of the contamination of the cabin air, especially as the air cannot usually be classified as toxic optically.

The cause of the polluted bleed air and its path from the engine to the cabin are shown below. Any illustrations are taken from the presentation by Scholz (2017), and are slightly modified by the author.

The interior of an arbitrary chosen engine (Figure 9.1) gives an insight into how it works.

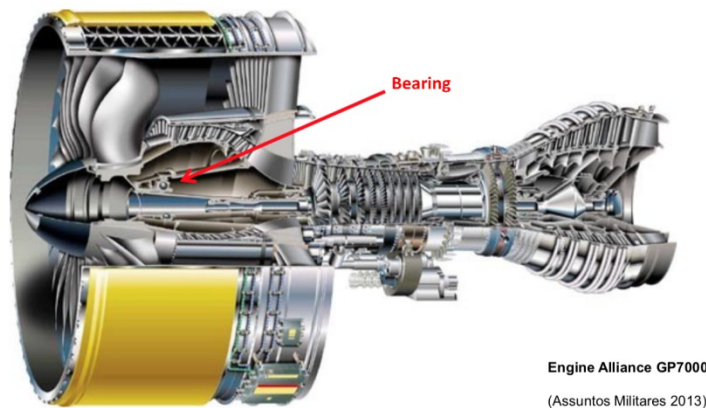

Figure 9.1 Graphic: Inner life of an engine (Scholz 2017)

To ensure that the shaft rotates smoothly, it is provided with a lubricated bearing. The engines are lubricated with a special oil from which, however, when heated, highly toxic to nerve-damaging vapours are produced, which may enter the breathing air of the passenger cabin unfiltered.

Figure 9.2 shows how air and oil mist leaves from the bearing chamber into the compressor.

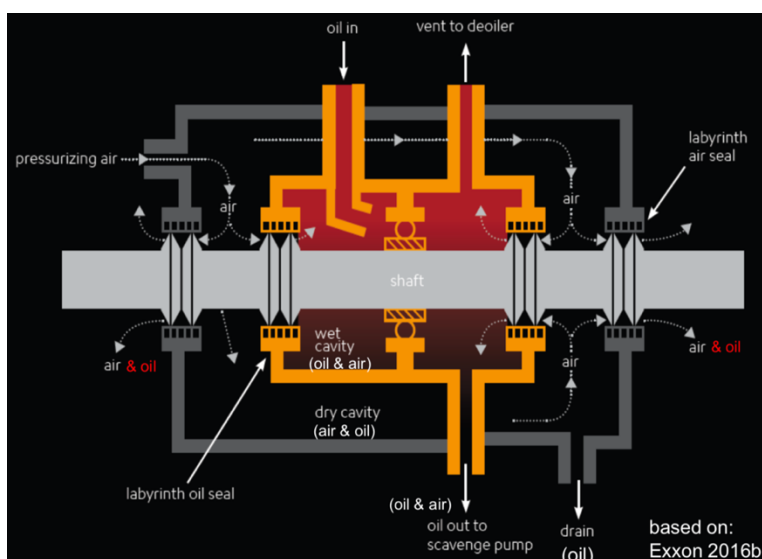

Figure 9.2 Processes in the compressor of the engine (Scholz 2017)

The toxic lubricant gases are conducted into the cabin as shown in Figure 9.3. It is frightening to discover that no seal is capable of completely sealing in practice and that oil residues, even if tiny, always remain in the air. Figure 9.3 shows furthermore the process of ventilation and temperature control of the cabin.

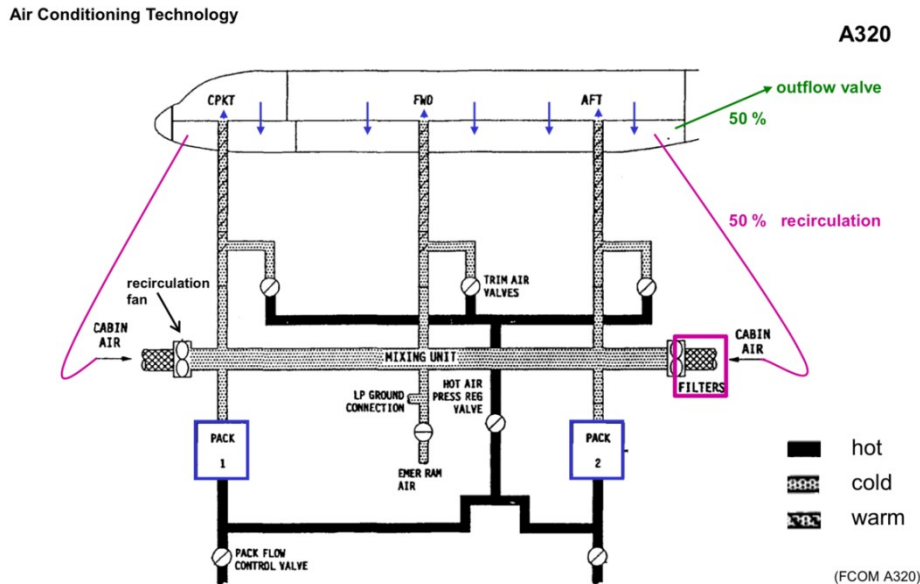

Figure 9.3 Temperature control of the cabin air (Scholz 2017)

The hot air is drawn from the engine behind the compressor, even before the combustion chamber, and fed to the packs via controlled valves. These have the task of cooling the several hundred-degree hot bleed air. In the *mixer unit*, the fresh supply air is mixed with the recirculated cabin air, which is filtered beforehand. The cold air is then brought to the appropriate temperature by adding hot air and fed into the respective cabin area. With today's state of the technology, it can be roughly said that approx. 50% of the cabin air enters the cabin again in recirculated form.

This is the path of air from the engine to the cabin. It can be seen that in the case of contamination of the air by lubricant gases, hardly any measures are taken for detection or prevention in today's aircraft. Seals and filters are demonstrably inadequate during operation and the consequences are therefore serious.

9.2 Engine Oil



Figure 9.4 Engine oil from Exxon (Scholz 2017)

The lubricant contains substances such as phenyl-naphthylamines and organophosphates, tricresyl phosphate (TCP) classified as highly dangerous by several toxicologists. During an investigation of samples secretly taken in 2008 in machines of various, predominantly German airlines, residues of tricresyl phosphate could be detected in 90 percent of the samples. The highest value of 154.9 micrograms of tricresyl phosphate was measured over an area of 2×2 cm in a Boeing 757 of the Condor. However, according to leading scientists, such as the American pharmacologist and neurobiologist Professor Dr. Mohamed B. Abou-Donia, TcP, or its toxic component triorthocresylphosphate, is not alone responsible for the symptoms and diseases. Rather, the scientist assumes that the chemical mixture of the various heated and thus altered substances leads to damage to the human organism.

9.3 Countermeasures

When the first commercial flights took place in 1958, passengers inhaled air taken directly from the immediate atmosphere and compressed by compressors. This mechanism could only prove its usefulness until 1962, when systems were introduced that supplied the cabin with regulated bleed air directly from the engine. This method has survived to this day. There is one exception, however, the new Dreamliner from Boeing, the B787.

The Boeing B787 puts an end to the bleed air taken from the engine. Air extracted from the atmosphere is compressed by the electrically powered pack and fed into the passenger cabin via the *heat exchanger*. The electrical supply is ensured by electrical generators, which in turn are supplied by the engines and the APU. This method shows how the formation of contaminated air in the core is preventively un-connected and is also a good model for future aircraft or current modification of existing aircraft.

When it is too costly to adapt existing systems to aircraft, filters are an alternative, if not sufficient, to prevent toxic gases from entering passengers' respiratory tract. Although filter sys-

tems for cleaning the cabin air have now been developed and officially approved, they are generally not used in passenger aircraft. Currently, such a system is only in use on BAe146/Avro Regional Jet aircraft at Swiss and on the Boeing 757 of the freight company DHL. With larger aircraft there are apparently problems with the required air throughput in the passenger cabin. So, there is an urgent need for optimization here.

The lubricants themselves can also be optimized to remove all toxic ingredients. It has been proven that today's engine oils contain fewer toxic substances. However, their use does not remain harmless.

Detectors in the cabin are also an option. These do not prevent the toxic gases from entering the cabin, but clarify them at an early stage so that appropriate measures can be taken in flight. Aviation authorities and companies are experiencing high demand for detectors for pilots and cabin crew, but refuse to follow up on them to this day and consequently ensure the health of personnel and passengers. In the case of a fume event recorded by detectors, pilots could take appropriate measures to avert more serious consequences. This includes identifying the source of the error by switching the bleed air valves on and off. If this is unsuccessful, bleed air must be taken from the APU instead of from the engines. In an emergency, pilots are forced to make an emergency landing. If there is no alternative airport in the vicinity, the pilots can even decide on direct ventilation of the cabin at an altitude of 10000 ft. The pressure cabin is lost and the speed must be significantly reduced due to higher air density. But the ambient air at this altitude is harmless to the human organism.

10 Scenario: Engine Failure

Passengers suffering from fear of flying can hardly imagine anything worse in flight than an *engine failure*. In fact, this case is extremely rare: a modern aircraft engine is estimated to fail every 30 years. The failure of an engine is particularly unproblematic when the aircraft is multi-engine. Today, commercial passenger jets are always twin-engine aircraft. In the past, only four-engine aircraft such as the Airbus A340, A380 and Boeing B747 were used for long overseas flights. With the advances in engine technology, more power-efficient and redundant engines have been produced. This is why, for cost reasons, twin-engine aircraft that comply with the so-called ETOPS regulations are also preferred for overseas long-haul flights.

10.1 Extended-range Twin-engine Operational Performance Standards (ETOPS)

ETOPS are regulations established by the American FAA, ICAO and EASA that allow airlines to plan a shorter flight route than the standard safety rules for reaching an alternative airport. According to these standard rules, routes must be planned so that the aircraft does not exceed a maximum distance from a potential alternative airport. The aim is to ensure that the aircraft can continue to reach the alternative airport safely in the event of an engine failure. The distance between the aircraft and the alternate airport is also measured in units of time. The ETOPS regulations allow airlines to increase the distance, i.e. the time required to reach the alternative airport, so that shorter routes can be flown more efficiently. The situation is illustrated schematically in Figure 10.1.

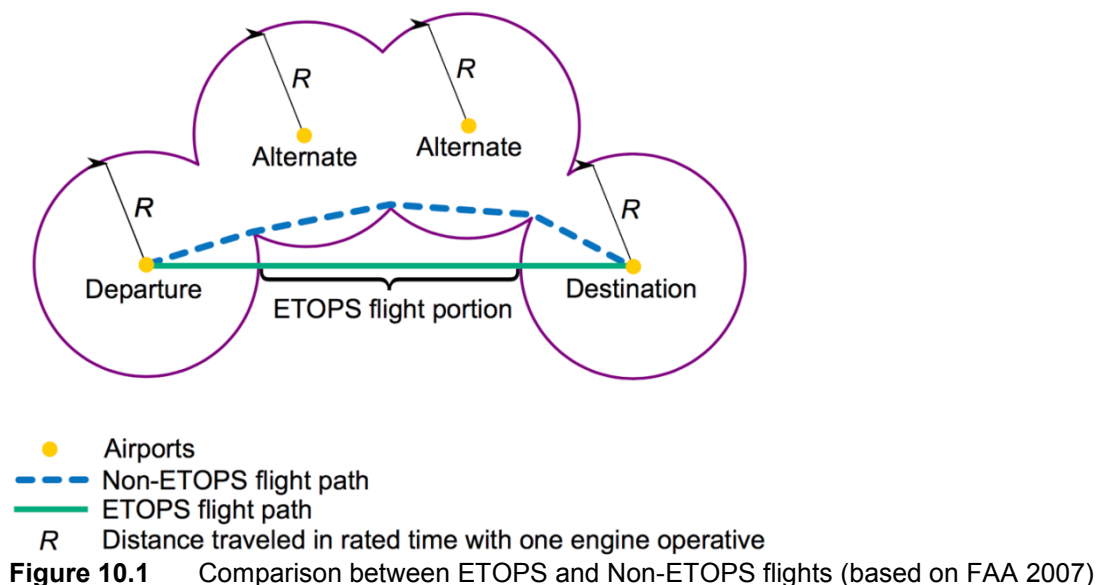

In order for ETOPS regulations to be applied, strict requirements must be met for the design of aircraft and especially engines, but also for maintenance and flight preparation and execution. The aim of the ETOPS regulations is to minimize the probability of engine failure by means of technical regulations and procedural requirements and to ensure that sufficient safety reserves remain in the event of engine failure (ICAO 2014).

10.2 Emergency in Cruising Flight

The only problem with the loss of an engine is the loss of thrust. The mechanisms and systems operated by the engine are designed to obtain the necessary energy elsewhere, e.g. via the *APU* or the *ram air turbine*. An engine failure often goes unnoticed by the passengers. The failed engine does not deliver thrust and although the other engine is running at maximum thrust, the machine will not be able to maintain its height. Due to the high cruise speed, the rudder can be stabilized, and any rudders can be operated by low control deflections. When an engine failure occurs, the pilots work through the flight manuals, this includes switching the engine on again after several attempts and planning the landing at an alternative airport. The failed engine remains idle and is disconnected from any system to prevent further damage.

10.3 Emergency at Departure

Such an engine failure immediately after take-off is much more critical. However, even this emergency situation is trained by pilots and can be provably controlled by the airline upon certification (ICAO 2010). The critical moment at take-off is exactly when the remaining distance on the runway is not sufficient for braking and the aircraft must therefore take off. All factors are quite unfavourable in this situation:

- Maximum weight: *maximum take-off weight*
- Minimum speed: v_{rotate} , take-off speed
- Control surface deflection difficult due to low inflow velocity

In such an engine failure scenario, the principle "fly the aircraft first" applies, i.e. the processing of the checklists provided for the case takes place after the aircraft is controlled in the air. The thrust loss of the engine is compensated by the rudder, so that the aircraft continues to move in the planned direction. A possible bank position can be compensated with the aileron, only small deflections are usually necessary. With the rudder trim, the pressure is taken from the pedals and the rudder deflection is set as the new zero setting of the pedals. Before each take-off, a departure procedure in the event of engine failure is defined and discussed by the crew. This plan is then adapted to the respective situation and the aircraft lands safely.

10.4 Two-sided Engine Failure

A failure of both engines (in a twin-engine aircraft) is a real problem, especially if the aircraft is already on low flight level. Such a scenario is very, very rare, however, can be considered on the basis of past cases. In the event of an engine failure on both sides, there is no device in the aircraft that can deliver thrust. This is therefore referred to as *total thrust loss*. The passenger plane weighing tons becomes a glider just at this moment, because smart gliding in the air is the only thing that allows pilots to reach the alternate airport in an emergency. It is understandable that the occurrence of an engine failure on both engines can have devastating consequences, especially after take-off. Consequently, there are high requirements for the certification and inspection of engines that ensure that the probability of a failure is negligibly low. The case of US Airways flight 1549 (Parker 2011) shows that despite the highest security precautions, uncontrollable events (in this case it was bird strike) do pose a certain risk. In the event of a complete loss of thrust, pilots are solely dependent on the glide ratio of the aircraft and can achieve the maximum glide ratio E_{\max} by making perfect use of aerodynamic conditions. At this moment, the heavy ton aircraft becomes a glider.

$$E = \frac{L}{D} = \frac{X}{Y} \quad (10.4.1)$$

An Airbus A320 usually achieves a glide ratio of $E_{\max} = 20$, the A380, the largest passenger aircraft in the world, but an astonishing value of $E_{\max} = 24$. The glide ratio E , the glide angle γ and the glide ratio ε are aerodynamic characteristics of an aircraft in stationary gliding flight. The glide ratio corresponds to the ratio of lift and drag and the ratio between horizontal distance covered and altitude loss in gliding flight. As a result, the A320 travels approximately 20 metres horizontally with a drop of one metre. An A320 flying at cruising altitude e.g. FL340 (34000 ft = 10363 m) can theoretically still cover about 207 km.

In the case of the US-Airways flight AWE 1549 the plane covered a distance of about 14 km, falling from about 3000 ft. This shows that the theoretical glide ratios cannot be achieved in reality. This is due to prevailing wind conditions, flight manoeuvres and human imperfections. If no potential landing area as in the above case can be reached, a so-called *ditching*⁷ must be taken into consideration.

The probability of an engine failure on both sides is so low in reality that there is no reason to worry. There is an old aviation proverb that says: "The likelihood of total thrust loss is less than the likelihood of choking on a peanut in flight."

⁷ Ditching is an emergency landing on the water by an aircraft which is not designed for water landings. Ditching is extremely rare in modern aviation. Ditching is an emergency landing on the water by an aircraft which is not designed for water landings. Ditching is extremely rare in modern aviation.

11 Scenario: Fuel Dumping

Fuel dumping is a standardised and in practice not infrequently applied procedure for pilots to achieve the corresponding maximum landing weight before an (emergency) landing by discharging fuel. In order to fully utilize aircraft capacity, which is always in the airline's financial interest, aircraft are filled to the predefined maximum take-off weight (MTOW) before take-off. However, the maximum landing weight (MLW) for many types is below the MTOW. If a landing is absolutely necessary immediately after take-off, the weight of the aircraft can be reduced to the MLW by the dumping procedure (Klußmann 2012).

In the 1960s, the U.S. FAA issued a regulation requiring a fuel dumping system for all aircraft whose MTOW exceeded the MLW by at least 5%. Initially, short-range aeroplanes did not reach the 105% limit, but this changed when they later reached higher ranges through larger tanks and were then affected by the regulation. Even later, the FAA repealed the regulation for jets that could take off with only one engine. The latter was due to the fact that engines were becoming increasingly powerful and the installation of jettison systems was costly. As a result, an emergency fuel dump was no longer required for twin-jet engines. Nowadays only long-range aircraft such as the Airbus A330 and A340, Boeing B747, B767 and B777 series as well as the MD11 and DC10 need to be equipped with such technology, as it can be seen in the resolution of the Bundestag (2018).

Fuel dumping takes place under certain regulations defined by the *International Civil Aviation Organisation* (ICAO). A minimum altitude of 6000 ft, i.e. about 1830 m, above ground level, applies to the process. In practice, fuel is often dumped at altitudes of four to eight kilometres. Furthermore, the pilot must maintain a minimum speed of 500 km/h, in practice it is often 600 km/h to 700 km/h. The German traffic control (DFS) strives to provide the aircraft with airspace with low air traffic over an area of minimal population density. For this reason, there is no fuel dumping in the immediate vicinity of airports, according to the Ministry of Economics, Transport and Regional Development of Hessen (2007).

In the fuel jettison system, the kerosene is sprayed out at the wingtips with high-performance pumps, swirling it into tiny droplets and distributed into a fine vapour by the turbulence behind the aircraft. The dumping process must be initiated manually by operating the buttons in the cockpit.

On the Airbus A380 the corresponding buttons are located in the *overhead panel*. The fuel to be discharged on the A380 is only taken from the *transfer tanks*. The kerosene in the *feed tanks* is excluded.

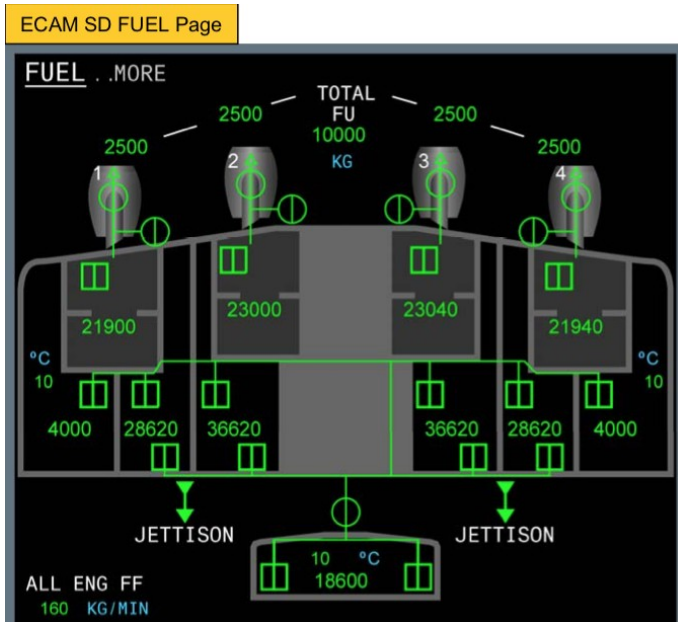

Figure 11.1 FUEL-Page on the ECAM of an A380 before a jettison operation (De Cespigny 2012)

The A380 achieves a discharge rate of 150 tonnes per hour.

The Ministry of Urban Development, Housing and Transport of the State of Brandenburg (2014) states:

„Bei einer angenommenen Fluggeschwindigkeit von 500 km/h und einer Gesamtablassrate mittels Schnellablassventilen von 1600 Kilogramm pro Minute sowie einer unterstellten Verteilungsbreite von einem Kilometer errechnet sich eine Verdünnung des abgelassenen Treibstoffs auf 0,21 Gramm je Quadratmeter. Der weitaus größte Teil des Nebels sinkt jedoch nicht zu Boden, sondern verdunstet noch in den höheren Luftschichten und verbleibt in der Atmosphäre, bis er durch die Strahlungsenergie der Sonne in Wasser und Kohlendioxid umgewandelt wird. Bei einem Treibstoffschnellablass in der Mindestflughöhe von 1500 Metern, bei Windstille und einer Bodentemperatur von 15° Celsius sind es rechnerisch ca. 8 Prozent der insgesamt abgelassenen Treibstoffmenge, die den Erdboden erreicht. Damit lässt sich eine theoretische Bodenbelastung von 0,02 Gramm Kerosin pro Quadratmeter ermitteln.“⁸

Rather, it can be assumed that the fuel released evaporates almost completely before it reaches the earth's surface. For this reason, it has not been possible to detect residues in either plant or soil samples after a fuel dumping event. The remaining concentration in the air is also so low that no danger to human health can be assumed, Tesseraux (1998, p.40). An alternative to fuel dumping is immediate landing with a higher landing weight than the permitted one, which is often the only option, especially in medical emergencies or critical technical problems. Al-

⁸ Translation by the author: At an assumed airspeed of 500 km/h and a total discharge rate of 1 600 kilograms per minute using fuel jettison valves and an assumed distribution width of one kilometer, a dilution of the discharged fuel to 0.21 grams per square meter is calculated. However, the vast majority of the fog does not sink to the ground, but evaporates in the higher layers of air and remains in the atmosphere until it is converted into water and carbon dioxide by the sun's radiant energy. With a fuel dumping at a minimum altitude of 1,500 metres, with no wind and a ground temperature of 15° Celsius, it is approximately 8 percent of the total amount of fuel dumped that reaches the ground. This allows a theoretical ground pollution of 0.02 grams of kerosene per square meter to be determined.

most all aircraft types are designed to be stable enough to land at their maximum take-off weight, but then costly investigations and possibly the repair of damage are necessary, as Colella 2007 states, which often exceed the price of the kerosene released.

12 Aircraft Structure

The topic of structural materials is probably one of the most important in aircraft construction, because unlike many other modifications to the aircraft, the choice of the appropriate material has a direct effect on the structural weight of the aircraft. In addition to other optimization goals, weight reduction is the primary goal of all developments, as aerodynamics, fuel consumption and ultimately the economic efficiency of the aircraft are directly linked to it. Intuitively it can be seen that the causality line in aircraft construction cannot be drawn directly from the cause to the effect, because cause and effect are chained together in such a way that the variation of a parameter has immediate consequences for supposedly distant state variables. For example, even a minimal change in the surface texture of the structural skin above the wing results in a higher aerodynamic frictional resistance, which in turn requires more speed for the same lift. This leads to increased fuel consumption, as the engines have to provide more thrust. If the aircraft is now to be able to cover the same distance, it must be refueled with more fuel, which in turn increases the weight of the entire aircraft. The increase in weight has a negative effect on fuel consumption and requires even more fuel et cetera. for the same flying distance. It can be seen that a modification to the aircraft is not directly proportional to its effect, but rather enters it with a factor (*snowball effect*).

Since the beginning of aviation, various, albeit few, materials have been processed in aircraft. The rather meagre variation in structural materials is mainly due to the difficult licensing and certification processes within the aviation industry. Therefore, there is a lot of potential in this area in particular in the future.

Basically, four construction methods can be distinguished from each other.

Wooden construction

The aircraft is built entirely of wood. The fuselage consists of longitudinal belts, frames and plywood planking. Some aircraft surfaces are covered with fabric. There are some aircraft of this type that are still in series production, such as the Pioneer 300, but above all this design is typical of gliders. The Hughe H-4 Hercules, with the largest wing span of 97.51 m ever built, is also made of wood.

Mixed construction

This construction method combines the timber construction with a construction made of metallic material. Here the covered fuselage is mostly formed by a metal construction, the surfaces are made of wood. Examples of such a design are the Piper PA-18 and the K 8, although the mixed construction method is rarely used in series today.

Metal construction

These airplanes are completely made of metal. The surfaces are not covered, but planked and riveted with sheet metal throughout. Examples are the Cessna 172 and Let L-13.

Fiber reinforced construction

This is currently the most popular construction method. The aircraft is made of fiber glass or carbon fiber plastic. Almost all components are made of this material.

12.1 Fiber-reinforced Composites in Aircraft Construction

In general, a fiber composite is a multi-phase or mixed material consisting of two main components. On the basis of mutual interactions between the individual components, higher-value properties are generated. Carbon fiber reinforced plastic (CFRP) is mainly used in aircraft construction. This is a composite material in which carbon fibers are embedded in a plastic matrix.

The matrix serves to connect the fibers and to fill the spaces between them. CFRP is used in particular where the higher costs are accepted for a lower mass and at the same time high rigidity.

With the Boeing 787-8, Boeing has succeeded for the first time in launching an aircraft on the market in which the mass fraction of fiber-reinforced plastic (FRP) is more than 50 percent. A short time later, Airbus responded with the A350 XWB, 53 percent of which is made of the ultra-light material. The manufacturers promise increased economic efficiency due to the use of fiber-reinforced plastics in the primary structure. Figure 12.1 shows the history and shares of FRP in the respective Airbus and Boeing models.

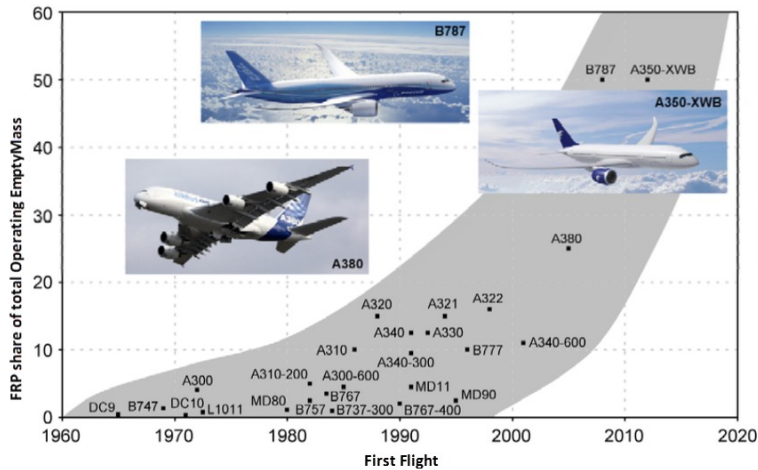

Figure 12.1 Entry of the FRP into load-bearing structures of commercial aircraft (based on Rieke 2013)

There are many reasons for the displacement of aluminium alloys. The demands placed on aircraft from an economic and ecological point of view call for ever more efficient and low-emission designs, which can only be fulfilled by manufacturers in the form of a holistically optimized design. The requirements for the primary structure can therefore be expressed in such a way that the technologically and functionally highest possible degree of lightweight construction is achieved, taking into account the financial framework. Looking at the mass distribution of existing medium and long-haul models in relation to the *manufacturer's empty weight* (MEW) (Figure 12.2), the weight potential of FRP in the primary structure can be easily estimated.

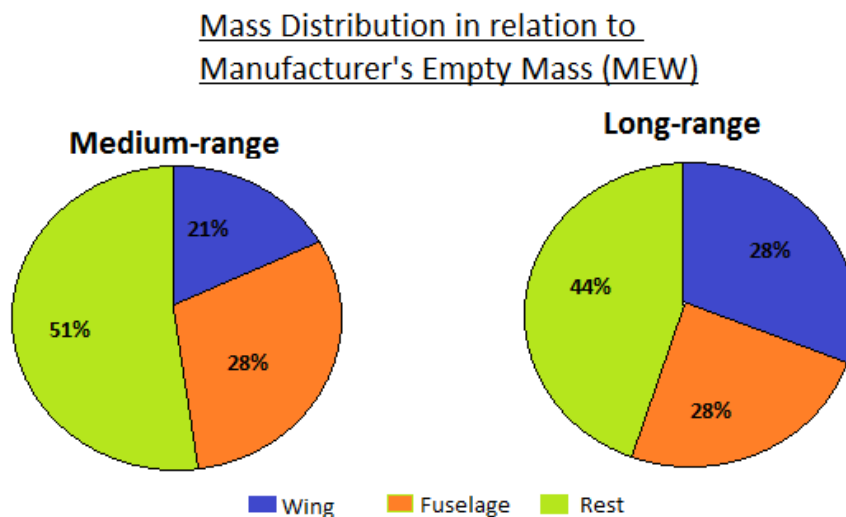

Figure 12.2 Mass distribution of a typical medium- and long-haul aircraft in relation to the manufacturer's empty masses

Since empennages in existing designs already partly consist of FRP, the following estimation is aimed solely at the consideration of fuselage and wings. These amount in total to about 49% (e.g. A320-200) and 56% (e.g. A340-300). Assuming, according to Rieke 2013, that the

primary structure accounts for approx. 80% of the total structural weight, the shares of the primary structure in the MEW are around 40% for the medium and around 45% for the long-haul aircraft. Heß (2009, p.1) shows that a CFRP structure equivalent to an aluminium alloy can achieve a weight saving of 30%. The entire structure cannot be made of CFRP. Therefore, a proportional use of CFRP in the primary structure of 60% is assumed for the calculation example. This reduces the savings potential from initial 30% to 18%. In relation to the medium-haul aircraft, this results in a reduction of 7% for the MEW, but still 8% for the long-haul aircraft. Considering the snowball effect described above, it would be wrong to consider the values for themselves. A magnification factor of 1.5 would determine the effects of the use of CFRP on other weight-reducing parameters of the aircraft with sufficient accuracy. The enlargement factor results in a weight saving of 11% for the medium and 12% for the long-haul aircraft in relation to the maximum take-off mass. Fuel consumption will then be reduced by 9% for the medium-haul aircraft and 12% for the long-haul aircraft, provided that the design parameters such as wing area or engine thrust have been optimized for the new maximum take-off mass. The calculation example shown, which of course is not intended to serve as a value-accurate analysis, shows how much potential is hidden behind the replacement of aluminium alloys by CFRP structures.

Obviously, a weight advantage can be achieved by the better density specific mechanical properties of CFRP compared to common aluminium alloys. However, the full potential of CFRP components can only be exploited if they are used cumulatively in areas with clear directions of main stress over all loads, as is the case, for example, with lift surfaces in large areas, and if they are also designed to meet exact failure criteria. According to Schürmann 2007, the use of FRP makes particular sense as long as a certain orthotropy can be implemented in the component, since a quasi-isotropic multilayer composite only has mechanical properties similar to aluminium and has solely a main advantage of a density that is approx. 33% lower. This is called "black aluminium", which was used in earlier designs to replace aluminium structures and was also designed rather conservatively. In the case of multi-axis loading, which in turn requires a quasi-isotropic multi-layer composite structure, the weight advantage is greatly reduced compared to aluminium, since the high specific values only apply in the direction of the fibers.

Furthermore, some literature sources claim that manufacturing FRP structures can save manufacturing costs compared to aluminum structures. This would be particularly the case if a change from the expensive production of *PrePregs*⁹ in *autoclaves*¹⁰ to resin injection processes, as currently used on the Boeing 787 for the fuselage barrels, takes place. Moreover, a cost reduction is justified by the fact that FRP buildings tend to be assembled into assemblies with less effort, e.g. due to the integral construction method. However, the production of the Boe-

⁹ Preimpregnated fibers: semi-finished fiber matrix products that are preimpregnated with reaction resins and used for the production of components are cured under temperature and pressure (in an autoclave)

¹⁰ The autoclave is a gas-tight pressure vessel which can be closed for thermal treatment of substances in overpressure ranges.

ing 787 shows that the latter are at best potentials, because the number of rejects and tolerance problems caused by a lack of experience in FRP production methods are currently leading to increasing costs than they are being reduced. Whether a cost reduction in production is at all possible, remains rather speculation than proven.

Furthermore, the introduction of FRP structures is expected to reduce maintenance costs on the basis of reduced fatigue. Nevertheless, it is still uncertain whether the expectations can be met in real operation, as in many cases damage can no longer be optically identified due to the more complicated sandwich and matrix structures of FRP parts. The detection of damage again requires cost-intensive and in some cases still to be developed non-destructive testing methods. The fuselage section is particularly plagued by visually invisible damage, as unexpected mechanical loads on the ground often cannot be absorbed, e.g. jostling during deboarding. Consequently, high safety factors are taken into account during design, which means that part of the weight advantage is lost. Some critics even think they can prove that a CFRP structure, while maintaining the same level of safety, has the same weight as an aluminium structure. A further challenge are the repair procedures for FRP, which are now satisfactorily mastered by experience with existing tail units and secondary structures. However, experience must still be gained in the field of purely bonded repairs of primary structures and a worldwide standard for ensuring the same quality must be achieved.

The reduced electrical conductivity of FRP materials has two significant disadvantages. On the one hand, any electrical loads must be supplied with the second pole via an additional cable instead of a connection to the structure, which means an additional weight. On the other hand, lightning and radiation protection is no longer guaranteed due to the absence of the *faradaic cage*. This results in the introduction of a fine copper or aluminium fabric into the CFRP structures and again has a negative effect on the absolute weight of the aircraft.

The vision of a material that is not affected by corrosion should also be treated with caution. Indeed, monolithic CFRP components do not exhibit any significant corrosion. Pairings between CFRP and base metals such as aluminium or steel must nevertheless be galvanically decoupled. The resulting reduced weight advantage can at least be partially compensated by the elimination of the necessary paintwork that would have been required for aluminium structures.

It is assumed that FRP will continue to make its way into the primary structure and its share of the aircraft will increase. To achieve this, however, investigations must be pursued with regard to optimum stress, *non-destructive testing* methods (NDT) and the exploitation of the maximum weight advantage, because the current stock shows that the potential of this material is far from being fully exploited. However, it remains unclear to what extent the introduction of FRP into the aircraft structure is appropriate in relation to the performance of the aircraft.

12.2 Back to the Future: Aluminium

At first glance, current trends always point to the use of CFRP in aircraft construction. A closer look, however, promises more in-depth knowledge about the extensive potential of aluminium. A material that initially had great difficulties to assert itself against the promising plastic composite materials, now seems to have a lot to offer. Thanks to its material properties, the wide range of machining and processing possibilities and its high recyclability, aluminium remains, in the opinion of many scientists, the material of the future par excellence. They continue to plead for more in-depth investigations of aluminium, as the full potential is far from being exhausted. It is no secret that aluminium can be manufactured by adding glass in the form of wafer-thin threads to a super-hard lightweight material that is not only much lighter but also harder than before.

Aluminium-Magnesium-Scandium Alloy

At the moment, manufacturers are increasingly using so-called *drop-in solutions*. The installation of components according to the drop-in principle aims to make already introduced model series easier and more efficient without deeply and cost-intensively interfering with existing designs. Components made mainly of an Al-Mg-Sc alloy are particularly suitable for this purpose. Aluminium associations say that the alloy makes it possible to make new, but above all already developed aircraft components significantly lighter. Compared to conventional aluminium-copper alloys, weight savings of around five percent can be achieved. The striking advantage here is that weight reduction is now achieved continuously rather than in phases when new aircraft models are introduced. Even aircraft developed decades ago can be modified to reduce weight and increase efficiency. The change in weight is due to the lower density. Copper, as a conventional alloying component, has a density of 8.92 g/cm³, while the value for magnesium is only 1.738 g/cm³. Scandium is mainly used to assign good machining properties to the alloy.

The material is currently being used as a drop-in solution in some areas of the aircraft, e.g. Airbus introduced Al-Mg-Sc, laser-welded landing flaps on some models.

Aluminium-Lithium Alloy: "Airware 2050"

The innovative aluminium alloy called *Airware 2050*, which contains lithium components, promises answers to the challenges of today's aviation industry. According to the manufacturer, in addition to weight savings of about 25 percent due to low density, the material offers improved material properties such as lower material fatigue and corrosion. The manufacturer promises (Constellium 2017):

"... Airware 2050-T84 is a low density aluminium-based alloy, developed to provide a lower density, higher modulus and higher corrosion resistance than currently available incumbent plate alloys. With higher strength, it provides an ideal low density and high damage tolerance balance solution, resulting in unique weight savings potential. Leveraging aluminium's infinite recyclability without property losses, Airware 2050 can be repeatedly recycled."

In addition, the use of Airware 2050 is recommended in areas of particularly high stress, including the lower wing surface and fuselage components such as frames and stringers.

The brochure from Constellium (2017) also lists a table (Figure 12.3), which provides information on the mechanical characteristics.

| Thickness range mm (in) | DIR | | 12.7 ≤ th ≤ 38.1 (0.5 ≤ th ≤ 1.5) | 38.1 < th ≤ 50.8 (1.5 < th ≤ 2) | 50.8 < th ≤ 76.2 (2 < th ≤ 3) | 76.2 < th ≤ 101.6 (3 < th ≤ 4) | 101.6 < th ≤ 127 (4 < th ≤ 5) | 125 ≤ th ≤ 175 (5 < th ≤ 6.9) |
|---|-----|------|--------------------------------------|------------------------------------|----------------------------------|-----------------------------------|----------------------------------|----------------------------------|
| Tensile strength MPa (ksi) | L | min | 503 (73) | 496 (72) | 496 (72) | 490 (71) | 490 (71) | 490 (71) |
| Yield strength MPa (ksi) | L | min | 476 (69) | 462 (67) | 462 (67) | 462 (67) | 455 (66) | 455 (66) |
| Elongation % | L | min | 8 (9) | 8 (9) | 7 (8) | 6 (7) | 5 (6) | 4 (5) |
| Toughness K1c MPa√m (ksi√in) | L-T | min | 36 (33) | 34 (31) | 31 (28) | 29 (26) | 28 (25) | 24 (22) |
| E (tension) Gpa (Msi) | | Typ. | 76.5 (11.1) | | | | | |
| SCC MPa (ksi) ASTM G47 | * | max | 450 (65.2) *LT | 350 (50.7) *ST | | | | |
| Density g/cm ³ (lb/in ³) | | Typ. | 2.7 (0.098) | | | | | |

Figure 12.3 Mechanical characteristics for Airware 2050 sheets of different thicknesses (Constellium 2017)

In addition, the manufacturer advertises simple production methods. Thus, the production of Airware 2050 should be possible on the basis of current machine production. Characteristic are low internal stresses and small deviations due to thermo-mechanical treatments. Ultimately, the material and any residues (chips, etc.) produced during production should be completely recyclable. In summary, the advantages can be visualized by the following graphic (Figure 12.4).



Figure 12.4 Comparison of the properties of Airware 2050 with a conventional aluminium-copper plate of 75mm thickness (Constellium 2017)

The agreements concluded between the Airware 2050 manufacturer and Boeing in 2013 and the recent talks with Airbus suggest the potential and future increased use of the aluminium-lithium alloy within the primary structure.

Additive Layer Manufacturing (ALM)

Additive Layer Manufacturing is one of several generative manufacturing processes in which a component is manufactured using laser technology and material dust. This is often referred to as *3D printing*.

Observing the current situation, ALM is currently in high demand in the aviation industry. According to the manufacturers, there are three reasons for this:

- **Cost reduction:**
Since there are no pre-run or tooling costs, all production costs flow exclusively into the production of the component itself. The demand for small series or individual pieces can be satisfied without additional effort.
- **Lightweight construction:**
Additively manufactured lightweight structures are able to reduce the weight by about 40-60% with the same high strength values. In addition, there is freedom in terms of design, as material is saved.
- **Tool-free production:**
The process requires less energy and material than conventional manufacturing strategies. Moreover, there are no storage costs, as most components are manufactured on demand.

In practice, the first additive components are used in aircraft.

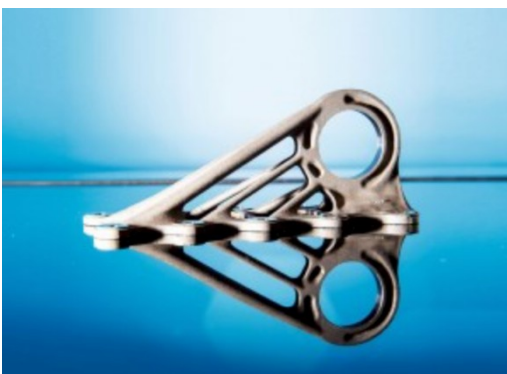

Figure 12.5 3D printed holder for the A350 XWB (Schmidt 2016)

Figure 12.5 shows a printed titanium part used in the Airbus A350. The so-called *bracket* was previously milled from aluminium. Any requirements regarding function and strength are fulfilled by the new holder, in this specific case the component delivers a weight reduction of around 30% compared to the conventional aluminium component.

The technology is not only promising in the field of production, but also in maintenance. For example, aircraft manufacturers could print parts according to original plans directly on site without large production facilities. Large stocks of spare parts, which are common today as a result of the long life-cycles of aircraft parts, and the capital tied up in them could be significantly reduced in the future.

However, additive manufacturing has its limits. On the one hand, the production process is almost exclusively suitable for small series up to 2000 units, and on the other hand component dimensions are very limited due to the limited installation space in the machine. In addition, complex after-treatments, such as micro-blasting, are required to achieve high surface qualities (Merger 2015). This is particularly necessary for highly stressed structural components, which often have life cycles of 30 years. In addition, this type of production requires a completely sealed installation space in order to guarantee a dust- and contamination-free process. Otherwise, countless ultra-fine particles are emitted.

At present it can be observed that particularly highly stressed and solid components are made of high-strength metals. Most of these have rather small dimensions and can also withstand high thermal stresses. The production of entire skin fields or similarly large structural parts has not been possible to date due to limited installation space. It is clear that the process is just starting in the aviation industry and has great potential for the future.

13 Cockpit: Fatigue

13.1 Facts and Figures

The influential globalization of the market means increasing mobility of people and has led to an enormous increase in air traffic. Figure 13.1 shows the increase in departures from about 6 million in 1970 to about 40 million in 2005: The application of modern redundant aircraft systems for better safety requires a rethinking with regard to the work requirements for pilots, since, for example, regulation and monitoring activities have increased and thus also the mental stress as explained by Wiener (1988, pp.433-459).

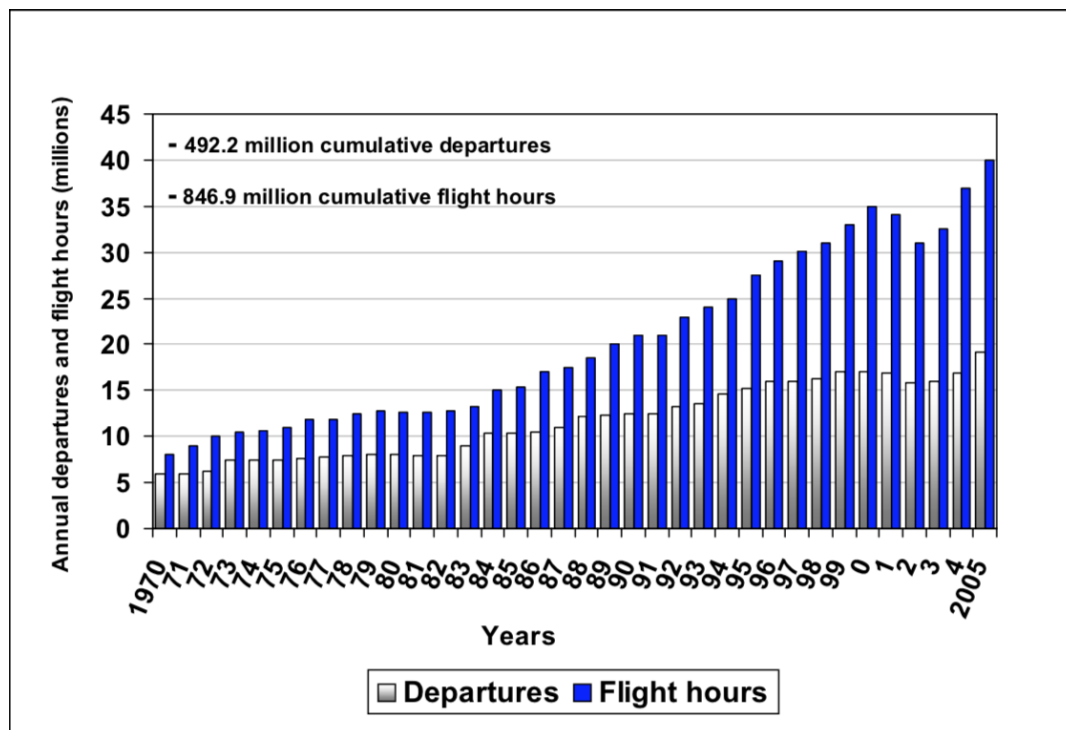

Figure 13.1 Departures and flight hours from 1970 to 2005 (Niederl 2007)

In addition, long non-stop flights on long-haul routes and the frequent use of aircraft on short-haul routes due to shift and night work, irregular working hours and time zone flights have changed the operational airfoil of the crew. This increases both psychological and physical demands on pilots. In addition, the activities of pilots are subject to continuous changes in civil aviation in terms of technology and operations, which always involve retraining and changeovers.

Increasing security is one goal of the companies, cost efficiency another. Not only due to the increasing traffic volume do airlines react with changing market strategies in order to cover the high passenger volume. Low cost carriers also create economic pressure. In order to maintain competitiveness, structural changes are made within the company in order to maintain

profitable cycles. This results in long flight service times and short rest periods for crew members with the aim of the airline to use the aircraft as effectively as possible.

The technical development of the aircraft brought previously unknown problems for the flight crew. Flight times increased due to long-haul flights. For the first time, the time difference caused physiological stress symptoms (*jet-leg*). Due to the still unexplored field, the interest in scientific work on flying personnel in civil aviation has so far mainly been in the acute effects of jet leg symptoms, fatigue symptoms and monotony during and after long-haul flights and hardly on the working environment of short-haul flight personnel.

Current discussions are therefore lacking studies of fatigue phenomena in the *multi-sector* (short-distance) area. In the United States, the fatigue of pilot crews was long considered relevant only on long-range services. In Europe, research on stress on short flights has made further progress. After this chapter has clarified basic terms firstly, it is therefore intended to deal not only with long-haul routes but also with short-haul routes, which are often ignored.

Workload and Fatigue

The term workload is the subject of countless attempts to capture it. According to the standard, DIN 2016, workload is understood as all the external conditions and requirements in the work system that affect a person's physiological and/or psychological state.

Westbrook (1966) recognizes that the workload of the pilots can only be roughly assumed, but not exactly recorded:

"If a reliable method were available to obtain a measure of workload or stress, it is undoubtedly true that many of the anomalies in handling qualities data could be explained... The implications on criteria for the design of new aircraft, their control systems and their display instrumentation are obvious ... And yet this capability of measuring, and understanding overall pilot workload and thereby being able to utilize this knowledge in vehicle design continues to elude us."

Especially the lack of a functioning measuring system to record the workload often leads to overstraining of pilots beyond the legal limits and precarious working conditions.

Fatigue, on the other hand, can be described a little more clearly. The ICAO (2013) defines the phenomenon as follows:

"A physiological state of reduced mental or physical performance capability resulting from sleep loss or extended wakefulness, circadian phase, or workload (mental and/or physical activity) that can impair a crew member's alertness and ability to safely operate an aircraft or perform safety-related duties. "

According to Caldwell 2012, symptoms can be slower reaction time, concentration difficulties, attention deficits, lack of anticipation of events, increasing risk tolerance, forgetfulness and reduced decision-making ability. Fatigue phenomena increase the probability of pilot er-

rors immensely and are therefore one of the greatest dangers in operational flight for crew and passengers.

The Reality in Figures

Caldwell (2004) estimates that approximately 4% to 7% of all civil flight incidents and accidents can be traced back to signs of fatigue in the cockpit. Goode (2003, pp.309-313) found in a study by the FAA that 5.62% of all air accidents caused by human error were caused by pilots on duty for 13 hours or more, the latter only applies to 1% of all pilots worldwide.

Interesting is the following study and its results of significant importance, which allow conclusions on real flight operations (Wilson 2007).

In the study, participants had to perform three different tasks that were based on activities in the cockpit. These were responding to warning lights, controlling a simulated cockpit and leading a simulated UAV¹¹ mission. All tasks were carried out by the participants in both a sleepy and tired state of mind. As expected, the response time for the warning lights increased from an initial 1.5 s to 2.5 s. It is astonishing, however, that no significant differences could be found in the other tasks. This means that the performance of pilots in tired condition does not depend solely on the degree of fatigue, but also on the required degree of effort required to perform the respective task. According to Wilson, the extent of the loss of performance is a function of the number of hours in an awake state and the required degree of performance.

PVTs are increasingly being used in scientific studies to measure performance as a direct result of fatigue or sleepiness. PVT stands for *psychomotoric vigilance test*. *Vigilance* can be understood as the unspecific organic reactivity or ability required to react to rare and accidental stimuli over long periods of time. Vigilance of human beings is subordinated to the conscious control. Mackworth conducted extensive research in this area and became known through the so-called *Mackworth Clock Test*¹². Mackworth (1948, p.6-21) describes vigilance as a

"... state of willingness to notice and respond to specific, minor changes occurring at random intervals in the environment..."

The objective results from the PVTs are compared in studies with subjective fatigue assessments and give clear indications of the performance at the end of a long period of flight service or during a landing approach after flight service through the *window of circadian low (WOCL)*¹³ via an empirically sufficiently large number.

¹¹ *Unmanned Air Vehicle*: an aircraft operated autonomously by a computer or remotely from the ground without a crew on board.

¹² A psychological test used to test and train the vigilance of individuals. It was developed for the pilots of the Royal Air Force.

¹³ The human body functions according to a neurological pattern that causes wakefulness during the day and fatigue at night. General aviation guidelines define the time window for natural human fatigue (WOCL) between 2 a.m. and 6 a.m.

Another study of the United States Air Forces by Van Dongen (2006, pp.333-343) found considerable discrepancies regarding the effects of fatigue effects on different individuals. Ten F-117¹⁴ pilots were tested in an exhausted condition. The test results showed individual-dependent deviations of about 50 percent, which did not allow a generally valid statement to be made.

The German Aerospace Center is also dealing with the phenomenon of exhaustion in the cockpit. As part of a research by the Institute of Aerospace Medicine, DLR 2008, a total of 50 pilots of two-man flight crews on various transmeridian and trans-equatorial long-haul routes during normal passenger flights were investigated. Sleep, workload, stress and fatigue were measured using EEG¹⁵, EOG¹⁶, ECG¹⁷ and subjective data. According to the pilots, the subjective workload on transatlantic flights was rather low, while it was perceived as moderately heavy on north-south flights. Both subjective data and recorded measurements showed in agreement that towards the end of the day flights to the American Atlantic coast and in any night flights an increased fatigue, which always increased with the flight duration, began. The results therefore show that extremely long day flights and especially successive night flights reach the limits of mental and physiological capacity.

In 2011, the new regulations on flight duty times in Europe prompted the Association Cockpit (VC 2011) to conduct a survey among its members. The survey was conducted online with a response rate of 43%, i.e. an absolute number of 2807 participants.

Fatigue Survey by Association Cockpit

Of the pilots surveyed, around 55 percent are on short-haul flights, 37 percent fly almost exclusively long-haul flights and a minority of 8 percent short and long-haul flights.

92 percent of the participants said they would have been so tired at least once in the last few years that they would not have been better off sitting in the cockpit. A total of 92% of long-haul pilots said they didn't even dare to drive a car after the flight, whereas the figure for short-haul flights is 85%. The situation of long-distance crews is therefore even more critical. The idea that the most demanding part of the flight, the landing, is carried out in an already overtired state is both obvious and alarming. Standby operations pose a particular problem. Here, 69% of the pilots claimed that they had already been too tired to take over the entire shift. This may be due to the fact that the standby time already worked by then is not counted towards the subsequent operating time in shift, which can theoretically lead to an additive increase in standby and duty time to 28 hours.

¹⁴ The F-117 Nighthawk is a twin-engine, single-seater aircraft developed in the 1970s for the US Air Force.

¹⁵ *Electroencephalography* (EEG): recording of electrical activities of the cerebral cortex in the form of a brain wave diagram - awake: low brain wave deflections, asleep: large brain wave deflections.

¹⁶ *Electrooculogram* (EOG): recording of movements of the eyeballs - slow eye movements occur when falling asleep.

¹⁷ *Electrocardiogram* (ECG): recording of the electrical activities of all heart muscle fibres - statements can be made on the properties and health of the heart.

Furthermore, the pilots were asked whether they had already fallen asleep at least once in the cockpit without consultation with their colleagues in the last three years. A frightening proportion of more than a third answered positively to this question and once again showed that fatigue in the cockpit is a serious and above all dangerous problem in today's aviation. The percentage is significantly increased by long-haul pilots, as this happens on average more frequently than short-haul pilots. The latter is demonstrably due, among other things, to the higher night-time share on long distances. Most of all, however, it affects pilots who fly both short and long-haul routes: about 48% of them have already fallen asleep unintentionally in the cockpit. This can be attributed to the lack of protection mechanisms, because the fact that there would be pilots who could fly in mixed operations was initially unthinkable when the flight time regulations were created. Only in the last three decades did an increasing number of aircraft types come onto the market, making it unexpectedly possible.

The survey also clearly confirms that fatigue leads to cockpit errors. A meaningful 93% affirmed that they have already made a mistake during a flight due to fatigue/exhaustion. Frighteningly, 14% added that they were already almost or actually involved in an incident because either they or the colleague were too tired.

13.2 Real Problems and Supposed Measures

By means of several questions, the aim was to investigate what the pilots consider to be the decisive problem areas of the current flight duty time regulation.

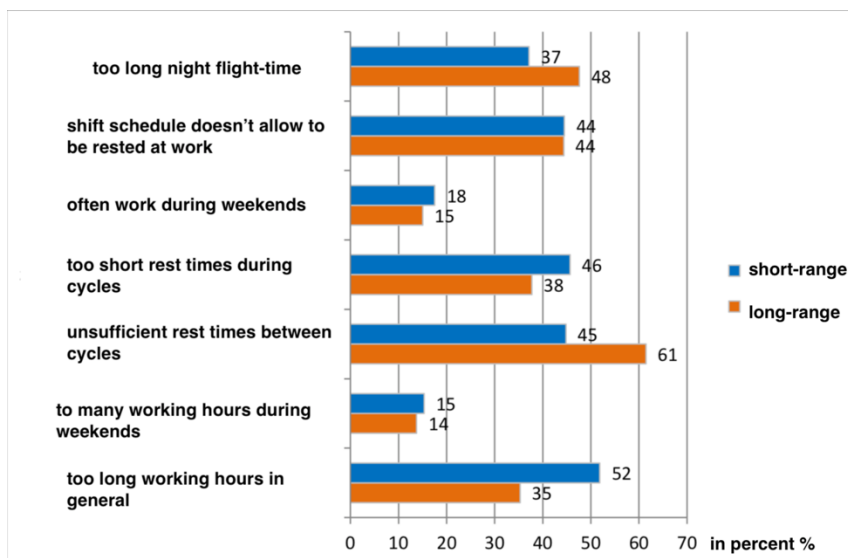

Figure 13.2 Pilots' opinions on the main problems of flight duty time regulation (based on VC 2011)

The main problem for long-haul pilots is the insufficient rest periods between two flights, i.e. many pilots do not feel sufficiently fit after a tour to complete a connecting flight with confidence. In the second place, almost half of the respondents complained about maximum night working hours. For long-haul flights, it can be assumed that at least one flight, either the outward or return flight, will take place at night in German airspace. In addition to the effects of jet lag, the higher sleep pressure at night also puts a strain on the crew.

Short distance pilots feel less the increased sleep pressure at night, as they rarely fly through complete nights. However, they often start very early and finish their shift very late, which is why this group of pilots criticize in particular the excessively long working hours and the excessively short rest periods between two cycles. Since on the one hand short distances, unlike long distances, are always flown by only two pilots and on the other hand the cockpit crew has to carry out several take-offs and landings in one day, the pilots have to perform their full work permanently, usually without a break. Time differences hardly play a role here.

Similarly, both groups - long- and short-haul pilots - claim that the flight duty time regulation does not allow them to show up for duty in a rested state.

Another problem is the so-called *commander's decision*.

Commander's Decision

The commander's decision is intended as an exception, which should only be used if unforeseeable delays occur. This means that this instrument is not intended for everyday cases that are regular and predictable. Nevertheless, about 66 percent of the pilots are sceptical about the commander's decision and state that they believe that the tours are planned in advance in such a way that the commander's decision is knowingly accepted or even provoked. In response to economic pressure to keep aircraft in flight for longer and longer, the legal maximum values have been pushed to the limit in recent years. If 13 hours of flight service are permitted for the pilots, the flight planning is partly adjusted to the minute for these 13 hours, although this leaves too little reserve for irregularities in operation. If an indispensable extension of the working time beyond the legal limit is recognizable for the captain, he can increase the working time from 13 to 15 hours in order to compensate for delays and complete the flight schedule. Participants reported that current planning strategies usually require either commander decisions or the last flight cannot be made. The latter means for the pilots in most cases that they and their crew have to stay abroad. This puts great pressure on the pilots, urging them to use the commander's decision. Short-haul pilots in particular have a negative opinion of the commander's decision that they had taken into account. The reason may be that short-haul flights in particular can be planned more easily to the limit of what is permitted by any combination than long-haul flights. Moreover, most delays occur on the ground. The more often the aircraft takes off and lands, the more likely it is to be delayed.

Unfit to Fly

The unfit-to-fly declaration was intended as a mean to combat fatigue during flight operations, but helps most affected pilots, if only in absolutely exceptional cases, as the survey by VC (2011) shows. Only one fifth of the pilots have reported unfit-to-fly at least once in the last three years. The hardly existing use of this legitimate method may have to do with the fact that pilots fear personal disadvantages from their employer when using it. Although pilots are legally obliged to perform their duties fit-to-fly, there are no legal protection measures for them that take action in the event of any displeasure on the part of the employer. The willingness to avoid work related consequences tends to lead pilots to hope to ultimately "get through" the service, and obviously reduces their risk awareness.

Napping

The napping policy is an emergency measure investigated by NASA sleep researchers and classified as recommendable, and was also introduced in the cockpit of civil aircraft some time ago. In the event of unpredictable, extraordinary fatigue, the pilot is granted a short, controlled deep relaxation in consultation with his colleagues. Various studies have shown that controlled sleep for 20 min to 30 min regenerates the brain and enables it to work for a limited period of time. Originally this measure was supposed to make the pilots fit again in a short time in absolutely exceptional cases. The pilots surveyed almost unanimously confirmed the effects of such a short sleep. However, more than 90% say that they have already made use of the method. This suggests once again that duty schedules beyond the human fatigue limits and the napping policy are drawn up taking into account. The latter is confirmed by the 98% agreement on the question of whether pilots would have shifts that would be difficult to maintain without napping. This makes it clear that this instrument is now so misused by flight planning that it has become routine. This is a highly worrying development and must be stopped in view of flight safety.

14 Autonomous Flight

14.1 The Autopilot

An *autopilot* is an automatic, usually programmable control system that automatically guides means of transport on request without people having to intervene in the control while the autopilot is active. It is usually a computer that processes environmental information from the instruments of the vehicle in order to determine how the vehicle is to be controlled. In case of difficulties, optical or acoustic warning signals are given.

The ever-increasing complexity of aircraft and the ever-denser traffic require a high degree of concentration and work from the pilot if he were supposed to manoeuvre the aircraft manually. An autopilot can relieve the pilot of his monotonous and tedious task of piloting the aircraft. The pilot is thus free to concentrate on other tasks (Kluwer 2003). Apart from precise control of the aircraft, autopilots also perform other tasks and support the pilot not only in normal flight. Modern systems are able to support the crew during landings and take-offs in bad weather conditions, such as strong winds and fog. But also, fully automatic landings in poor visibility up to *zero visibility* are among the areas of application of the system.

Autopilots are divided into three categories. A distinction is made between how many axes of the aircraft the autopilot can control. A distinction is made between:

- uniaxial autopilots,
- two-axle autopilots (with or without altitude preselection),
- triaxial autopilots and
- four-axle autopilots.

The uniaxial autopilot only controls the rudder to steer the vertical axis. This is also called *yawing*. Only a fixed *heading* is held. The two-axis autopilot also activates the *elevator* to control the aircraft around its cross-axis (*pitch*). Thus, the altitude can also be controlled in flight. The three-axis autopilot controls all control surfaces of the aircraft in order to control all three axes. The longitudinal axis is added to the other two axes (*roll*). Sometimes the term four-axis autopilot is used in technical literature. However, here not an axis in space is designated, but the *thrust vector* is counted as the fourth axis. Such systems can purposefully control the thrust of the engines to maintain a fixed speed or automatically control the thrust during landing.

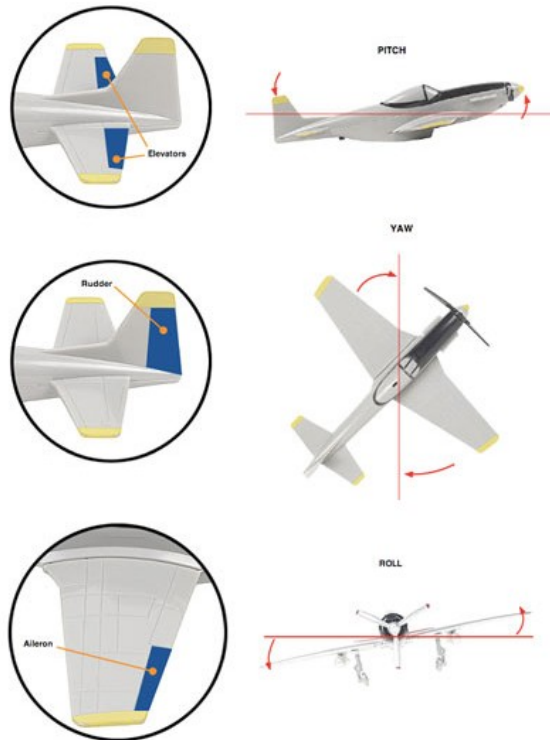

Figure 14.1 Rotation axes and control surfaces (Harris 2007)

The autopilot (AP) is an essential avionics system because it keeps the aircraft precisely in a stable flight position. The system consists of two control *loops* (Moir 2003, p.273). The *inner loop* is responsible for a stable flight attitude. Here the AP computer receives data, for example from the height sensor. If there is a deviation from the desired flight altitude, the computer controls the actuators of the respective control surface; in our example, the elevator. Feedback from the actuator ensures that the servomotors reach and maintain the desired position. The movement of the respective control surfaces changes the position of the aircraft, which in turn is picked up by the respective sensor, provides aerodynamic feedback, and is transmitted back to the AP computer. Manual input from the pilot is sent directly to the AP computer, thus overwriting the current system controls, allows the pilot to intervene at any time. A schematic structure of the internal control loop can be seen in Figure 14.2, but this is not generally valid and depends on the technical literature used. An example can be seen at “*Civil Avionics Systems*” by Ian Moir and Allan Seabridge. Here, manual control attacks the control surfaces directly. This internal *control loop* is the same for all three axes, only the controlled surfaces and sensors are different. The second control loop is the *outer loop*. This generates the commands for the internal control loop. Thus, the outer loop is not responsible for a stable flight attitude, but generates the commands necessary to steer the aircraft so that it follows a desired heading or performs the desired manoeuvre. The necessary calculations are generated by the *Flight Director* (FD) (FAA 2009, p.G-2). Here, the AP-Controller receives the data of the respective sensors and compares them with the desired, as in this example the heading. If a heading error is detected, the FD calculates which manoeuvre is necessary to correct it. The necessary commands for the maneuver are then forwarded to the AP computer via the control-

ler. At this point, the inner control loop takes over all further commands and addresses the required actuators of the respective control surfaces.

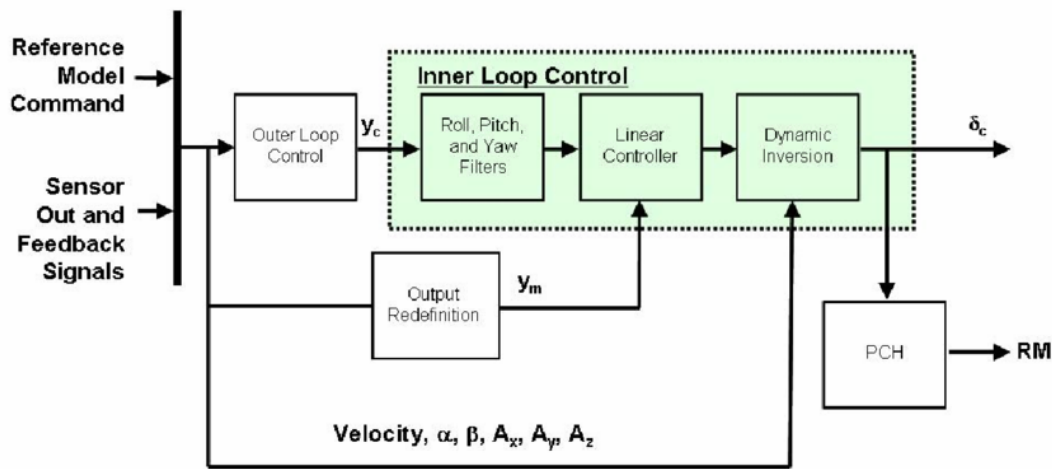

Figure 14.2 Functional principle of the loops

In addition to heading, descent and climb speed as well as height can also be communicated to the system. These allow the system to keep the aircraft stable in the air around all three axes, Reed 2013 concludes.

Nowadays, some autopilots are even able to perform the entire landing on their own. Landing with an autopilot on the runway and the subsequent rolling out on the runway centre line is called *CAT III landing* or *autoland*. A CAT III landing requires an appropriately equipped and certified aircraft, a trained and certified crew and an appropriately equipped and certified airfield. Apart from certain aircraft types, CAT III landings may only be flown with the autopilot due to its approximately four times higher reaction speed. Landings according to CAT IIIa and IIIb are currently being carried out. In addition to braking on the web, CAT IIIc also includes leaving the runway.

In order to understand common functionalities of the autopilot, it is recommended to have a look at the same during cruise flight. When the aircraft has climbed to the desired altitude after take-off, it switches to horizontal cruising flight. As long as the aircraft is moving straight ahead under constant internal and external conditions (weight distribution, earth atmosphere, etc.), the flight altitude remains constant. However, the aircraft becomes lighter due to the consumption of fuel and thus begins to climb. Therefore, the *barometric altimeter* will soon detect a deviation from the preselected altitude. The *pitch channel*, which controls the angle of attack, sends a signal to the elevator to compensate the difference until the set height is reached again. Since the loss of weight can reduce the lift and therefore the angle of attack and thus the drag, the airspeed increases, which is why the *speed channel* (*Auto Throttle Computer*) now adjusts the engine power so that the preselected altitude is maintained at the preselected (optimized) target speed.

The direction of flight is controlled via the *roll channel*. Assuming the pilot sets 315° as a heading, i.e. exactly to the northwest. If the external conditions, such as the wind direction, change, the aircraft will drift out of the calculated course unless countermeasures are taken. A compass system now measures the deviation from the preselected direction and sends a signal to the ailerons to compensate - the aircraft rolls a little (turns sideways about the longitudinal axis). The rudder works like a false keel and the aircraft additionally rotates around the vertical axis until the course is 315° again. The roll channel then returns to a central position. During the lateral movement the aircraft had a higher drag and took the nose downwards - whereupon the pitch channel had immediately responded and the nose had steered up again. This correction had also caused additional drag and reduced speed, so the speed controller had to increase the engine power again.

In addition to these standard routines, there are a large number of other control functions that intercept unwanted movements and make the flight more pleasant for passengers. Pilots, on the other hand, can concentrate on their activities in demanding flight phases - such as before landing or when air traffic control changes their plans - without having to continually readjust the aircraft.

It can be seen that the autopilot performs a wide range of tasks for the crew. Not only cruise flight, but also climb and descent and even the landing itself can be carried out automatically. In very exceptional cases, the pilots only complete a few settings and the computer does the work.

The question of whether aviation will allow autonomous flying to enter the market in the foreseeable future is therefore more than justified.

14.2 Definitions

In this discussion, autonomous flying is defined according to NHTSA (*National Highway Traffic Safety Administration*). In the absence of an equivalent classification in aviation, a classification from the vehicle industry is used below, which can easily be transferred to air transportation. Further considerations vary between *Level 3 - Limited Self-Driving Automation* and *Level 4 - Full Self-Driving Automation*. According to NHTSA, the levels are defined as follows:

“Level 3 - Limited Self-Driving Automation: Vehicles at this level of automation enable the driver to cede full control of all safety-critical functions under certain traffic or environmental conditions and in those conditions to rely heavily on the vehicle to monitor for changes in those conditions requiring transition back to driver control. The driver is expected to be available for occasional control, but with sufficiently comfortable transition time. The vehicle is designed to ensure safe

operation during the automated driving mode. An example would be an automated or self-driving car that can determine when the system is no longer able to support automation, such as from an oncoming construction area, and then signals to the driver to reengage in the driving task, providing the driver with an appropriate amount of transition time to safely regain manual control. The major distinction between level 2 and level 3 is that at level 3, the vehicle is designed so that the driver is not expected to constantly monitor the roadway while driving.

Level 4 - Full Self-Driving Automation: The vehicle is designed to perform all safety-critical driving functions and monitor roadway conditions for an entire trip. Such a design anticipates that the driver will provide destination or navigation input, but is not expected to be available for control at any time during the trip. This includes both occupied and unoccupied vehicles. By design, safe operation rests solely on the automated vehicle system."

The difference between Level 3 and Level 4 is therefore that in Level 3 the driver or pilot must intervene in the event of a fault; in Level 4 this is not intended.

14.3 Regulations

There are a large number of regulations governing air traffic. There are superordinate ones which, for example, affect the entire EU and others which regulate the respective countries. Regulations are usually one of the most difficult hurdles to certify a new technology. In this case, certification is hampered, among other things, by the Chicago Convention (1944, p.5):

"No aircraft capable of being flown without a pilot shall be flown without a pilot over the territory of a contracting state without special authorization by that state and in accordance with the terms of such authorization. Each contracting state undertakes to insure that the flight of such aircraft without a pilot in regions open to civil aircraft shall be so controlled as to obviate danger to civil aircraft."

This authorization would have to be granted in general terms in a new joint decision so that the administrative burden for the airlines does not arise. The air traffic regulation, LuftVO 2015, applicable in Germany also prohibit the flying of unmanned aeroplanes which have a take-off weight more than 25 kg.

Existing regulations would have to be changed in the future to enable autonomous flights in purely legal terms. Among other things, it must be determined who will take control in case a system failure occurs during the flight. This means that it must be clarified whether autonomous flight is permitted according to Level 3 or 4. The question of guilt, should a crash occur, must also be answered.

Conclusion is, that regulations for autonomous flying must be adapted worldwide. This could certainly be achieved through appropriate political and bureaucratic effort.

14.4 Technical Feasibility

The technical requirements for autonomous flying are already in place, as Northrop Grumman's *Global Hawk*, a military drone that flies autonomously, shows.

A major sticking point in commercial aviation is the number of aircraft flying simultaneously in the air. Today's data transmission bandwidths are barely sufficient to control air traffic from the ground. This means that a permanent data transmission cannot be guaranteed. However, this is required to enable autonomously flying aircraft to communicate with each other and thus enable a safe and controlled flight.

Consequently, the expansion of data transmission must be driven forward in order to be able to implement autonomous flying.

14.5 Most Frequent Causes of Accidents in Regular Flights

According to Bennett 2015, Director of the Civil Safety and Security Unit (CSSU) of the University of Leicester, the most common causes of accidents in civil aviation are due to human error. The causes of the accident are as follows:

- Pilot error 50%
- machine errors 20%
- Weather 10%.
- Sabotage 10%.
- other forms of human error 10%

In summary, 70% of all accidents can be attributed to the human factor.

So, autonomous flying can potentially significantly reduce the number of air accidents. It must be mentioned here that accidents caused by sabotage cannot be prevented by autonomous flying. In extreme cases, sabotage can even be simplified by hacking the flight control unit during autonomous flight.

14.6 Safety

The safety requirements for passenger aircraft are extremely high. The probability of a catastrophic error must be less than 10^{-9} 1/FH. This low probability of failure must at least be

achieved in autonomous flying, if not undercut, in order to obtain certification. This requires very reliable systems with at least one redundancy more than previous systems in order to replace the pilot factor. These systems are on the one hand very expensive and on the other hand they result in increased weight.

Conclusion: the prescribed safety can be achieved through a certain cost and additional weight on board.

14.7 Passenger's Perception

A representative survey conducted by Bitkom Research (2016) on behalf of the digital association Bitkom provides interesting results on the subject of autonomous flying. For this survey, 3516 people aged 14 years and over were interviewed, including 994 who have travelled by air within the last 12 months.

This survey shows that passengers are very sceptical about autonomous flying. Only 8% of all respondents can imagine a flight in an aircraft without a pilot. The main reason for the rejection of autonomous flying is based on the fact that the respondents have more confidence in human pilots than in technology, especially in exceptional situations.

In this context, the survey does not show whether passengers are aware that today's flying is already a highly automated process and that the pilot usually has the function of monitoring this process. We can state, that at present time an autonomous aircraft would not be accepted by the passengers.

14.8 Costs – An Estimation

Three aspects must be taken into account when discussing costs:

- Cost savings through elimination of pilot, co-pilot and traffic control salaries
- Cost increase through the installation of more redundancy systems and generally even safer systems in an aircraft and cost increase through the expansion of data networks worldwide
- Cost increase by ground personnel (here referred to as ground pilots), who must intervene on board in the event of a technical failure and land the aircraft safely by remote control.

Calculating an exact number is almost impossible in this case, as the variables cannot be estimated with sufficient accuracy. Nevertheless, Wensorra (2018, pp.27-31) conducted the attempt. With conservative assumptions and simplified calculation methods, they have succeeded in demonstrating that autonomous flying has economic savings potential in the long term. Although implementing autonomous flights in commercial aviation initially involves high investment costs, these pay off for airlines in the long term.

14.9 Bottom Line

Table 14.1 Evaluation matrix: autonomous flight

| Criteria | YES | NO |
|-------------------------------|--|----------------------------|
| Regulation | Realizable with high time expenditure | |
| Technical Feasibility | Realizable by expanding data transmission | |
| Most Frequent Accident Causes | The number of air accidents could potentially be reduced | |
| Safety | Realizable through a certain cost expenditure | |
| Passenger's Perception | | Not accepted by passengers |
| Costs | Cost savings realistic | |

As it can be seen in Table 14.1, only one of the points discussed has a negative evaluation. Passengers are currently refusing to be flown autonomously. The past has shown that people are often critical of new technologies in the very beginning, but accept them after a while and integrate them into their everyday lives. This will probably also be the case with autonomous airplanes. This is especially true when aircraft manufacturers and airlines provide active information on this topic and make passengers aware of how high the automated part is already in civil aviation today and how much safer this automation has made flying. All other points showed a positive result in terms of feasibility.

15 Summary

In the beginning, the aim was to clarify the basic aspects of aircraft aerodynamics. This includes a basic understanding of the physical phenomenon of lift and the significant effects of winglets on this and other parameters of the aircraft. Inductively, a reason was given why lift occurs and to what extent the attachment of supposedly efficient winglets to wing tips is preferable. Subsequently, several parts of the aircraft had to be examined. These were the windows, cabin doors and last but not least the function of the cabin structure as lightning conductors. Fears were calmed because the hole in the cabin, the opening of the door during flight and the electrical conductivity of the fuselage structure are cleverly solved from an engineering point of view and should by no means be regarded as a source of danger. The oval shape of the windows, like the hole in the windows, is a protective measure to avoid overload on the hull structure. Opening the door in flight is prevented inasmuch as the passenger has to make a rotation movement of the door inwards, which is impossible to perform with human force, in order to unlock the door from the frame. Lightning strikes are harmful to the aircraft structure, but the cabin remains unaffected by a lightning strike. Furthermore, it turned out that the request to switch all devices into flight mode or even to switch them off completely is no more than a noise reduction measure. The myth that the waves could disturb the aircraft systems is theoretically possible under very unfavorable conditions, but far from reality. Afterwards it could be proved that oxygen masks have sufficient oxygen reserves, because the only aim is to prevent unconsciousness during the fast descent to human-friendly heights. Unlike the cabin air itself, the oxygen from the masks can be inhaled without worrying. It is more difficult with the cabin air, which demonstrably contains engine oil gases in very low concentrations due to a lack of technical protective measures. The toxicity and health effects of inhaling the substance have been demonstrated. The second half of the work was initiated by means of two scenarios. The former is the horror scenario par excellence, the engine failure. In this respect, various procedures and precautions have been outlined which, in turn, make such an engine failure nearly unproblematic. The latter scenario was that of an aircraft that had to land earlier than planned but is still too heavy. In this case, the pilots carry out the procedure of a fuel dumping. The condition is that the heavily sprayed fuel has little or no effects on humans and nature. Then the paper took up the challenge of new structural materials and examined some current and assessed supposedly future compatible materials. At the end it was about the source of danger in the cockpit which is the human itself. Studies and independent analyses of trade unions and scientific institutions followed, which allow statements on the fatigue problem in the cockpits. So, if humans are the greatest danger in flying, the leading question of the last chapter was: why not simply replace them with automated flying? So, we reached the topic autonomous flights. For this purpose, rough rules were listed, thought experiments and rough estimations were made in order to assess the implementation of the concept.

16 Outlook

The report showed that aviation is diverse. Countless peculiarities, secrets and misunderstandings are part of aviation, a few of them could be identified and worked out through the report. Aviation may not be the most obvious science, but it is a little closer to us. The necessary intellectual tool to understand phenomena, processes and parts of the aircraft is created by the report. The fact that aviation is one of the few fields with an infinitely wide range of disciplines makes it quite difficult to understand it perfectly. Moreover, as it is actually the case in both the humanities and social sciences, it is shaped by different views and opinions. It must therefore be pointed out that this report is also based on one particular view, namely that of the author. Current trends show that flying is becoming more and more commonplace for the general public. Well, I believe, however, that this has not necessarily made aviation more comprehensible. Certain fields of knowledge can be covered more adequately, while others remain controversial. Rather, it is the challenges of the future, including increasing efficiency, reducing pollution, etc., that make aviation even more complex and thus create even more myths in the end.

List of References

- ANDERSON, D. and EBERHARDT, S., 2001. *Understanding Flight*. McGraw-Hill.
- BABINSKY, H., 2005. *Journal of Physics Education*. Department of Engineering, University of Cambridge, vol. 38. Available at: https://www.youtube.com/watch?v=Vx_6zhMRFgU, archived as: <https://bit.ly/2tXHpuf>
- BENNET, S.A., 2015. *The five most common reasons for airliner disasters*. The Conversation. Available at: <https://theconversation.com/the-five-most-common-reasons-for-airliner-disasters-50100>, archived as: <https://bit.ly/2tUGpqC>
- BFU, 2012. *Britische Boeing 737-800 im Notsinkflug – Problem mit Kabinendruck-Controller*. Accident Report by the Federal Office for Flight Investigation (BFU).
- Bitkom research, 2016. *Noch große Skepsis gegenüber autonomen Fliegen*. Berlin. Available at: <https://www.bitkom.org/Presse/Presseinformation/Noch-grosse-Skepsis-gegenueber-autonomem-Fliegen.html>, archived as: <https://bit.ly/2u8HniB>
- BRAIN, M., 2001. *How Airplane Cabin Pressurization Works*. How Stuff Works. Available at: <http://blogs.howstuffworks.com/2011/04/12/how-airplane-cabin-pressurization-works-keeping-you-comfortable-in-the-death-zone-at-33000-feet/>, archived as: <https://bit.ly/2KjffUV>
- Bundestag, 2018. *Sachstand: Zu Umweltauswirkungen durch Treibstoffschnellablass*. Research Service, ref.no.: WD 8-3000-049/17. Available at: <https://www.bundestag.de/blob/543808/666e35f2b36d6aafc0010aced9f9a5f/wd-8-049-17-pdf-data.pdf>, archived as: <https://bit.ly/2KzyxWc>
- CALDWELL, J.A., 2012. *Crew Schedules, Sleep Deprivation and Aviation Performance*. Current Directions in Psychological Science. SAGE journals. Available at: <http://journals.sagepub.com/doi/abs/10.1177/0963721411435842?journalCode=cdpa>
- CALDWELL, J.A., 2004. *Fatigue in aviation*. Travel Medicine and Infectious Disease. Available at: <https://www.ncbi.nlm.nih.gov/pubmed/17292011>, archived as: <https://bit.ly/2ITSgdu>
- Chiacago Convention, 1944. *Convention on International Civil Aviation Done at Chicago on the 7th Day of December*. Chapter II, article 8: *Pilotless aircraft*, p. 5. Available at: http://www.wipo.int/edocs/lexdocs/treaties/en/icao-ca/trt_icao_ca_001en.pdf, archived as: <https://bit.ly/2KyyxFZ>

COLELLA, R., 2007. *Overweight Landing? Fuel Jettison? What to consider*. Boeing, Flight Operations Engineering. Available at:

http://www.boeing.com/commercial/aeromagazine/articles/qtr_3_07/article_03_1.html, archived as: <https://bit.ly/2tYJ9Ds>

Constellium, 2017. *Airware 2050-T84 Plate*. Brochure. Available at:

https://www.constellium.com/sites/default/files/markets/airware_2050_t84_plate.pdf, archived as: <https://bit.ly/2NtxVPE>

DE CRESPIGNY, R., 2012. *QF32 Back Story – Cold Weather Operations and Christmas*.

QF32. Available at: <https://qf32.aero/2012/12/11/1526/>, archived as: <https://bit.ly/2KB8ptZ>

DIN, 2016. *Ergonomics principles in the design of work systems*. DIN EN ISO 6385:2016.

DLR, 2008. *Stress und Ermüdung im 2-Mann-Cockpit auf Langstrecken*. German Aerospace Center (DLR), Institute of Aerospace Medicine. Available at:

https://www.dlr.de/me/Desktopdefault.aspx/tabid-2008/2931_read-4499/, archived as: <https://bit.ly/2z9EraY>

EBERLE, P., 1997. *Der Modellflieger*. Stephanskirchen. Vol. 5. Available at: http://www.air-race.at/index.php?option=com_content&view=article&id=24&Itemid=37, archived as:

<https://bit.ly/2KQhoU8>

FAA, 2007. *Extended Operations (ETOPS) of Multi-Engine Airplanes*. Federal Aviation Administration, Department of Transportation. Available at: <https://www.gpo.gov/fdsys/pkg/FR-2007-01-16/pdf/07-39.pdf>, archived as: <https://bit.ly/2KwSCfH>

FAA, 2009. *Advanced Avionics*. US Dep of Transportation, p. G-2.

Flug Revue, 2007. *Dichtung und Wahrheit – Passagiertüren in Verkehrsflugzeugen*. Vol. August. Available at: <http://michael-lagemann.com/artikel/011-flugzeugtueren/pdf1-flugzeugtueren.pdf>, archived as: <https://bit.ly/2MNEDyO>

GERO, D., 1994. *Flugzeugkatastrophen*. Stuttgart.

GOODE, J.H., 2003. *Are pilots at risk of accidents due to fatigue?* Journals of Safety Research. Vol. 34 - Issue 3, pp. 309-3013. Available at:

<https://www.sciencedirect.com/science/article/pii/S0022437503000331?via%3Dihub>

HARRIS, W., 2007. *How Autopilot Works*. Available at: http://objectwiki.sciencemuseum.org.uk/wiki/Fuselage_of_de_Havilland_Comet_Airliner_GALYP, archived as: <https://bit.ly/2sZXu1f>

HAWLEY, J.A. and REILLY, T., 1997. *Fatigue revisited*. Journal of sports sciences. Available at: <https://www.tandfonline.com/doi/abs/10.1080/026404197367245>

HEB, H., 2009. *Experimentelle Charakterisierung und kontinuumsmechanische Simulation des Versagensverhalten strukturell vernähter Faser-Kunststoff-Verbunde*. TU Kaiserslautern, Faculty of Mechanical and Process Engineering. Dissertation, p. 1.

HINKELBEIN, J. and DAMBIER, M., 2007. *Flugmedizin und Flugpsychologie für die Privatpilotenlizenz*. Vol. 1, aeromedConsult Hinkelbein Dambier GbR, p. 78.

HOERNER, S.F., 1965. *Fluid-Dynamic Drag*. Hoerner Fluid Dynamics, Bricktown New Jersey.

ICAO, 1999-2007. *Aerodrome Standards: Aerodrome Design and Operations*. ICAO Annex 15, vol. 3. Available at: <https://www.icao.int/Pages/PageNotFound.aspx?requestUrl=https://www.icao.int/safety/Implementation/Library/Manual%20Aerodrome%20Stds.pdf>, archived as: <https://bit.ly/2IWGZQD>

ICAO, 2010. *Airworthiness of Aircraft*. ICAO Annex 8, vol. 11. Available at: <https://www.universiteitleiden.nl/binaries/content/assets/rechtsgeleerdheid/instituut-voor-publiekrecht/lucht--en-ruimterecht/international-air-law-moot-court/annex-8.pdf>, archived as: <https://bit.ly/2zfmAj6>

ICAO, 2013. *Operation of Aircraft - Annex 6*. International Civil Aviation Organization. International Standards and Recommended Practices. Available at: [https://www.icao.int/safety/fatiguemanagement/FRMS%20Tools/Amendment%2037%20for%20FRMS%20SARPS%20\(en\).pdf?TSPD_101_R0=5d949d481d87e7cd78ba5465c9925770kaC000000000000000032bb255ffff0000000000000000000000000000005ad87770007aca0cbc](https://www.icao.int/safety/fatiguemanagement/FRMS%20Tools/Amendment%2037%20for%20FRMS%20SARPS%20(en).pdf?TSPD_101_R0=5d949d481d87e7cd78ba5465c9925770kaC000000000000000032bb255ffff0000000000000000000000000000005ad87770007aca0cbc) archived as: <https://bit.ly/2MNGCDg>

ICAO, 2014. *Basic Concepts – Module N°2*. EDTO Workshop. Available at: https://www.icao.int/SAM/Documents/2014-EDTO/EDTO%20Module%20%202%20-%20Basic%20concepts.pdf?TSPD_101_R0=1b29751042b64757ad67134436004346n85000000000000007b5d168dffff00000000000000000000000000000005acf4b490031b5005f, archived as: <https://bit.ly/2tULi2W>

ICAO, 2017. *Annex 2 to the Convention on International Civil Aviation*. Rules of the Air. 10th Version, pp. 1-2.

JONES, R.T. und LASINSKI, T.A., 1980. *Effect of Winglets on the Induced Drag of Ideal Wing Shapes*. NASA TM-81230, Report No. A-8329, Ames Research Center, CA, USA. Available at: <http://www.engbrasil.eng.br/artigos/art60.pdf>, archived as: <https://bit.ly/2IT4XoF>

KAEMPF, P., 2013. *Is a winglet better than equal span extension?* Aviation Stackexchange. Available at: <https://aviation.stackexchange.com/questions/8556/is-a-winglet-better-than-an-equal-span-extension>, archived as: <https://bit.ly/2KzYcOf>

KLUßMANN, N. and MALIK, A., 2012. *Lexikon der Luftfahrt*. Springer, Vol. 3

KLUWER, C., 2003. *Introduction to Avionics System*. R.P.G. Academic Publisher. 2nd Edition.

KROO, 2007. *Induced Drag and the Trefftz Plane*. Applied Aerodynamics – A Digital Textbook, Stanford, CA. Available at: <http://docs.desktop.aero/appliedaero/potential3d/InducedDrag.html>, archived as: <https://bit.ly/2IVmmgs>

LARSON, G.C., 2001. *How Things Work: Winglets*. Air & Space Magazine. Available at: <https://www.airspacemag.com/flight-today/how-things-work-winglets-2468375/>

LuftVO, 2015. Luftverkehrs-Ordnung. Part 5a paragraph §21b section 2. Federal Ministry of Justice and Consumer Protection. Available at: https://www.gesetze-im-internet.de/luftvo_2015/BJNR189410015.html, archived as: <https://bit.ly/2zf5Xny>

MACKWORTH, N.H., 1948. *The breakdown of vigilance during prolonged visual search*. Quarterly Journal of Experimental Psychology, Vol. 1, pp. 6-21.

MAYER; I., 2007. *Auswirkungen von Winglets auf die Aerodynamik eines Flugzeugs*. Kantonschule Schaffhausen. pp. 34-35. Available at: http://www.fliegerweb.com/inhalte/Airliner/Reportagen/Maturaarbeit_Winglets/Maturaarbeit_Winglets.pdf, archived as: <https://bit.ly/2MRMrj7>

MCLEAN, D., 2005. *Wingtip Devices: What They Do and How They Do It*. Boeing Performance and Flight Operations Engineering Conference, section 4. Available at: http://www.smartcockpit.com/docs/Wingtip_Devices.pdf, archived as: <https://bit.ly/2u85CgB>

MERGER, D., 2015. *Bionik als Konstruktionsmodell für Leichtbau-Flugzeuge*. ke NEXT - Additive Manufacturing. Available at: <https://www.ke-next.de/panorama/schneller-fliegen-bionik-als-konstruktionsmodell-fuer-leichtbau-flugzeuge-123.html>, archived as: <https://bit.ly/2IVcXpp>

Ministry of Economics, Transport and Regional Development of Hessen, 2007. *Planfeststellungsbeschluss zum Ausbau des Verkehrsflughafens Frankfurt Main*. Ref.no.: 661-003. Available at: https://wirtschaft.hessen.de/sites/default/files/HMWVL/plafe_teil_a_verfuegender_teil.pdf, archived as: <https://bit.ly/2tSCueb>

Ministry of Urban Development, Housing and Transport of the State of Brandenburg, 2014. *Planfeststellungsbeschluss: Ausbau Verkehrsflughafen Berlin-Schönefeld*. Ref.no.: 44/1-6441/1/101. Available at: https://www.berlin-airport.de/de/_dokumente/nachbarn/2004-08-13-planfeststellungsbeschluss.pdf, archived as: <https://bit.ly/2KRXDit>

MOIR, I. and SEABRIDGE, A., 2003. *Civil Avionics System*. Professional Eng. Publishing UK, p. 273.

NELSON, T.R., 1993. *Falling Stars – Investigation of Comet accidents, Part 2*. In *Aeroplane Monthly*, p.20.

NEUBER, H., 1937. *Kerbspannungslehre – Theorie der Spannungskonzentration – Genaue Berechnung der Festigkeit*. Vol. 4, Springer.

NHTSA. *Preliminary Statement of Policy Concerning Automated Vehicles*. United States Department of Transportation, National Highway Traffic Safety Administration, Washington D.C. Available at: https://www.google.com/url?sa=t&rct=j&q=&esrc=s&source=web&cd=2&ved=0ahUKEwjCOurXlbXbAVFJFAKHSy2AyIQFgg_MAE&url=https://www.nhtsa.gov/staticfiles/rulemaking/pdf/Automated_Vehicles_Policy.pdf&usg=AOvVaw1kzgMhDIOOc-olHnCFb4os, archived as: <https://bit.ly/2MNIIzg>

NIEDERL, T., 2007. *Untersuchung zu kumulativen psychischen und physiologischen Effekten des fliegenden Personals auf der Kurzstrecke*. German Aerospace Center (DLR). Institute of Aerospace Medicine, p. 14.

Pan Am, 1963. *Boeing 707-121, N709PA near Elkton*. Pan American World Airways, Civil Aeronautics Board.

PARKER, L. and PROCHNAU, W., 2011. *Notlandung im Hudson River. Was geschah auf Flug 1549? Passagiere und Augenzeugen rekonstruieren die sensationelle Notwasserung von*

Flugkapitän Sullenberger. MavenPress. Available at:

http://media.hugendubel.de/shop/coverscans/136/13655857_lprob.pdf, archived as:
<https://bit.ly/2NpZXeO>

REED, N., 2013. *Der Autopilot, eine kurze Einführung*. University of Würzburg, Aerospace Information Technology. Available at: https://wuecampus2.uni-wuerzburg.de/moodle/pluginfile.php/123614/mod_resource/content/1/Autopilot.pdf, archived as: <https://bit.ly/2IYXQlv>

RIEKE, J., 2013. *Bewertung von CFK-Strukturen in einem multidisziplinären Entwurfsansatz für Verkehrsflugzeuge*. TU Braunschweig, Institute of Aerospace Engineering and Lightweight Construction. CFF – Investigation-report 2013-02.

SCHERRER, M., 2004. *Kerbspannung und Kerbformoptimierung*. Research Center Karlsruhe, Institute of Material Sciences, pp. 54-55.

SCHLICHTLING, H. and TRUCKENBRODT, E., 2001. *Aerodynamik des Flugzeugs 1 (Klassiker der Technik)*. Springer.

SCHMIDT, T., 2016. *Potenzialbewertung generativer Fertigungsverfahren für Leichtbauteile*. Springer, vol. 1.

SCHOLZ, D. and NITA, M., 2012. *Estimating the Oswaldfactor from Basic Aircraft Geometrical Parameter*. HAW-Hamburg for the German Aerospace Congress, Berlin. Available at: <http://profscholz.de/>, archived as: <https://bit.ly/2IU5spt>

SCHOLZ, D., 2017. *Aircraft Cabin Air and Engine Oil - An Engineering View*. International Aircraft Cabin Air Conference 2017, London. Available at: <http://profscholz.de/>, archived as: <https://bit.ly/2IU5spt>

SCHOLZ, D., 2018. *Definition and discussion of the intrinsic efficiency of winglets*. HAW-Hamburg for the Aerospace Europe CEAS 2017 Conference, Romania.

SCHÜRMAN, H., 2007. *Konstruieren mit Faser-Kunststoff-Verbunden*. Springer, Berlin Heidelberg, vol. 2.

Science Museum London, 2009. *Fuselage of De Havilland Comet Airliner G-ALYP*. Science Museum, London, Kensington. Available at: http://objectwiki.sciencemuseum.org.uk/wiki/Fuselage_of_de_Havilland_Comet_Airliner_G_ALYP, archived as: <https://bit.ly/2sZXu1f>

STARMER-SMITH, C., 2008. *Is cabin air making us sick?* The Telegraph. Available at: <https://www.telegraph.co.uk/travel/travelnews/759562/Is-cabin-air-making-us-sick.html>, archived as: <https://bit.ly/2zfmcbBa>

Stefan, J., 1966. *Expansion of a Pressure Cabin*. Drawing in Wikipedia, Berlin.

Tagesspiegel, 2014. *Lufthansa erlaubt dauerhafte Handynutzung im Flugzeug*. Written by KRAMER, S. Available at : <https://www.tagesspiegel.de/wirtschaft/auch-bei-start-und-landung-lufthansa-erlaubt-dauerhafte-handynutzung-im-flugzeug/9555296.html>, archived as: <https://bit.ly/2MSX591>

Telegraph, 2017. *The 31 biggest secrets of air travel*. Available at: <https://www.telegraph.co.uk/travel/travel-truths/The-secrets-of-air-travel/>, archived as: <https://bit.ly/2KBxd56>

TESSERAUX, I., MACH, B. and KOSS, G., 1998. *Flugzeugtreibstoffe und Flugzeugemissionen – Eine Risikocharakterisierung für Flughafenanwohner am Beispiel des Hamburger Flughafens*. Mainpaper for Hygiene and Environmental Medicine, p.40.

VAN DONGEN, H.P.A; CALDWELL, J.A. and CALDWELL, J.L., 2006. *Investigating systematic individual differences in sleep-deprived performance on a high fidelity simulator*. Behavior Research Methods, Vol. 38 – Issue 2, pp. 333-343. Available at: <https://link.springer.com/content/pdf/10.3758%2FBF03192785.pdf>

VC, 2011. *Ergebnisse der Fatigue-Umfrage der Vereinigung Cockpit*. Cockpit Association (Vereinigung Cockpit). Frankfurt am Main. Available at: https://www.vcockpit.de/fileadmin/dokumente/tarif/ContactAir/Ergebnisse%20der%20Fatigue-Umfrage%20der%20Vereinigung%20Cockpit_01.pdf, archived as: <https://bit.ly/2IVmmgs>

WENSORRA, A., STOCKMEIER, N. and ROENNEBECK, B., 2018. *Designwettbewerb der AIAA*. Hamburg University of Applied Sciences, pp. 27-31.

WESTBROOK, C.B., ANDERSON, R.O. and PIETRZAK, P.E., 1966. *Handling Qualities and Pilot Workload*. AF Flight Dynamics Lab., Wright-Patterson AFB.

WIENER, E., 1988. *Human factors in aviation*. Cockpit Automation. E.L. Wiener & D. Nagel (Hrsg.). USA: Academic Press, INC, pp. 433-459.

WILSON, G.F; CALDWELL, J.A. and RUSSEL, C.A., 2003. *Performance and Psychophysiological Measure of Fatigue Effects on Aviation Related Tasks of Varying Difficulty*. The International Journal of Aviation Psychology, Vol. 17 – Issue 2. Available at: <https://www.tandfonline.com/doi/ref/10.1080/10508410701328839?scroll=top&>