



Hochschule für Angewandte Wissenschaften Hamburg
Hamburg University of Applied Sciences

Master Thesis

Department of Automotive and Aeronautical Engineering

The Aviation Fuel and the Passenger Aircraft for the Future - Bio Fuel, Synthetic Fuel

Author: RAMACHANDRAN Karunanidhi

Examiner: Prof. Dr.-Ing. Dieter Scholz, MSME

Delivery date: 15.06.2015

Abstract

This work is a review and analysis of the advantages and disadvantages of alternative fuels - bio fuels and synthetic fuels - and the possibility to use them in air transportation. It has been shown that alternative fuels can be used in aircraft engines without modifications. Alternative fuels are applied to reduce green house gas emissions, but the reduction potential strongly depends on the source of the alternative fuel. There are great opportunities for alternative fuel production. However, large investments in new production plants would be necessary. Bio mass is the source for bio fuel. Also algae can be used as a source for bio fuel. Synthetic fuel is produced through the Fisher-Tropsch (FT) process. Synthetic fuel can be produced from coal, natural gas (also from bio mass) or even directly from water and CO₂ with alternative energy. Synthetic fuels have almost the same performance as jet fuel. However, synthetic fuel from coal (CTL) or natural gas (GTL) leads to high CO₂ emissions into the atmosphere. Sun to Liquid (STL) and Power to Liquid (PTL) methods even take CO₂ out of the atmosphere during the production process (releasing the CO₂ back again into the atmosphere in flight). Nevertheless, these methods are still in laboratory or demonstrator scale. Published test data about the certification of alternative fuels is given. Flight tests done with the alternative fuels are listed for further reference. Most importantly, the thesis provides some insight into the consequences of using alternative fuels in aviation with respect to aircraft design and aircraft performance as a function of fuel density and energy content. Life cycle assessment (LCA) need to be carried out to find the exact level of the Green House Gas (GHG) emission level for alternative fuels. LCA results of alternative fuels are compared with results from an LCA of conventional jet fuel.

© This work is protected by copyright

The work is licensed under a Creative Commons Attribution-NonCommercial-ShareAlike 4.0 International License: CC BY-NC-SA
<http://creativecommons.org/licenses/by-nc-sa/4.0>



Any further request may be directed to:

Prof. Dr.-Ing. Dieter Scholz, MSME
E-Mail see: <http://www.ProfScholz.de>

Download this file from:
<http://library.ProfScholz.de>



DEPARTMENT OF AUTOMOTIVE AND AERONAUTICAL ENGINEERING

The Aviation Fuel and the Passenger Aircraft for the Future - Bio Fuel, Synthetic Fuel

Background

Our planet is a finite entity and as such also energy stored on it is finite. Our planet offers carbon-based fossil fuels (coal, oil, and gas) ready to be used. Burning these fuels releases CO₂ into the finite atmosphere of our planet which leads to global warming. The question is simply, if taking from one limited reservoir and releasing into another limited reservoir may empty the first reservoir or may overflow the second reservoir within the foreseeable future. Whatever happens first (a reservoir being empty or overflowed) will be the limiting factor for the system. What will happen first? We live in a growing fossil fuel economy where emptying and filling takes place at an increasing rate. At what speed do we want to approach the inevitable. The question is will fossil fuel get too scarce and thus too expensive to be used? Or will CO₂ levels reach climate effects (droughts, flooding, severe storms) the earth's growing population can not cope with? Air transportation is one part of the growing carbon economy and has to carry its share in problem solving. The related research question for aviation is here: What is the best fuel strategy for passenger air transport in a post-fossil fuel era? In a post-fossil fuel era energy will come from renewable energy (wind, solar, bio-mass ...). Most forms of renewable energy (wind, solar ...) will be available primarily as electricity. Electrical energy could be stored in batteries; alternatively, energy could also be converted into a chemical form (gaseous or liquid fuel) to be stored on board. Other forms of renewable energy (like bio mass) could be converted directly to drop-in fuel. The best fuel option for passenger aircraft becomes visible only if aircraft are designed with all iterations and snowball effects for the energy option selected. **Three Master Theses have been set up as a trilogy** to investigate this:

The Aviation Fuel and the Passenger Aircraft for the Future –

- a) Batteries
- b) Hydrogen
- c) Bio Fuel, Synthetic Fuel

Batteries: In a post-fossil fuel era (regenerative) energy will exist first of all as electricity. To avoid energy conversions (always going along with energy losses), it makes sense to try direct storage and use of electricity. But batteries are heavy – a contradiction to the first rule in aircraft design: "Watch the weight!"

Hydrogen: Hydrogen production from electricity is simple through electrolysis and today with 70 % already quite efficient. Hydrogen powered aircraft have already been built and have been flown successfully. Hydrogen is a tested technology in aviation that will work. It makes sense to look again at this concept with new ideas to limit investment and to avoid a bulky aircraft.

Bio Fuel, Synthetic Fuel: The best fuel is the fuel we have today. Kerosene has a high energy density by weight and by volume. Drop-in fuels are those renewable fuels which can be blended with today's fuel and can be utilized in the current infrastructure and with existing equipment. Drop-in fuels generally have similar parameters and can be blended at various ratios up to 100 %. The challenge here is with availability of bio fuels compared to the huge demand. In a post-fossil fuel era synthetic fuel will come from a power to liquid (PTL) process based on regenerative energy. Will it be possible to scale up the processes fast enough and to deliver at a compatible price? The challenge here is the fuel and not the aircraft.

Task

This Master Thesis on **The Aviation Fuel and the Passenger Aircraft for the Future – Bio Fuel, Synthetic Fuel** will be dominated by a literature review on the energy alternatives.

- Review of bio fuel production from plants and micro organisms (algae).
- Review of synthetic fuel production especially from sun to liquid (STL) and power to liquid (PTL)
- Review of certification regulations for jet fuels.
- Review of fuel parameter variations and consequences for aircraft design.
- Review of the environmental impact of bio fuels and synthetic fuels considering their life cycle.

The report will be written in English based on German or international standards on report writing.

Declaration

Here with I affirm that this master thesis is entirely my own work. Where use has been made of the work of others, it has been fully acknowledged and referenced.

Date:
June, 2015

Signature:
Karunanidhi RAMACHANDRAN

Contents

	Page
Abstract.....	1
List of Figures.....	6
List of Tables.....	8
List of Symbols	9
List of Abbreviations.....	10
1 Introduction.....	11
1.1 Motivation.....	11
1.2 Objectives	11
1.3 Structure of this Project	12
2 Background	13
3 Bio Fuel.....	18
3.1 Bio Fuel from Plants.....	18
3.2 Bio Fuel Production from Micro Organisms - Algae	23
4 Synthetic Fuel.....	29
4.1 Gas to Liquid	29
4.2 Biomass to Liquid.....	41
4.3 Coal to Liquid	42
4.4 Sun to Liquid	45
4.5 Power to Liquid and Power to Gas	50
5 Certification and Regulations for Alternate Fuels	52
5.1 ASTM Approval Process for Alternative Fuel	52
5.2 Gas Turbine Fuel Test Methods	54
5.3 Test Results and Comparison for Synthetic Jet Fuel Blends	57
5.4 Comparison of SPKs.....	57
6 Aircraft Design for Bio Jet Fuel and Synthetic Jet Fuel.....	66
6.1 Low Calorific Value (LCA) of Alternate Fuels.....	66
6.2 Range & Payload Diagram	67
6.3 Design Appraisal for Alternative Fuel Aircraft.....	71
7 Life Cycle Assessment	73
7.1 Petroleum Fuel LCA.....	75
7.2 Bio Jet Fuel LCA.....	76
7.3 Synthetic Fuel LCA	77

7.4	CO ₂ Emission Comparison	83
8	Flight Tests Done with Alternative Fuels	85
9	Environmental Impact	88
10	Conclusion	89
	References	90

List of Figures

Figure 2.1	Oil Discoveries: Oil Discoveries Decreasing and Consumption Increasing (Campbell C.J 2006)	13
Figure 2.2	World Oil Reserve and the Dollars per Barrel in Years (1980-2006) (Shafiee 2009)	14
Figure 2.3	Demand for more than 31,000 New Aircrafts (ICAO 2013)	15
Figure 2.4	Number of New Deliveries Based on the Size of the Aircraft (ICAO 2013)	16
Figure 2.5	CO ₂ Emission in 2050 by Considering Different Possible Measures (Marsh 2008)	17
Figure 3.1	Jatropha Curcus with the Seeds (Bionas 2011)	19
Figure 3.2	Palm Oil Seeds and Palm Trees (Dekel oil 2014)	20
Figure 3.3	Transesterification Process (USDA 2010).....	22
Figure 3.4	Production Process (USDA 2010)	22
Figure 3.5	Algae Bio Fuel Production Process (Gehrer 2014)	23
Figure 3.6	Raceway Ponds (Nrel 1998).....	24
Figure 3.7	Large Scale Production Farm (Nrel 1998)	25
Figure 3.8	Tubular Photo Bioreactors in Horizontal Setup (Yusuf 2007).....	26
Figure 3.9	Fence Arrangement (Yusuf 2007).....	26
Figure 3.10	Helical Bioreactor Arrangement (Yusuf 2007)	27
Figure 3.11	Biomass Recovery (Yusuf 2007)	28
Figure 4.1	Overall Process for Synthetic Fuel Production (Ronald 2004).....	29
Figure 4.2	Distribution of Organic Carbon in Earth Reservoirs (NOAA 2001).....	30
Figure 4.3	Locations of the Methane Hydrates All Around the World (Smith 2011)....	31
Figure 4.4	Model of a Methane Hydrate Molecule (Smith 2011).....	32
Figure 4.5	Burning Methane from Methane Hydrate (Smith 2011).....	32
Figure 4.6	Hydrate Phase Diagram (Mushtaq 2012)	33
Figure 4.7	Methane Hydrate Stability Graph (Smith 2011)	34
Figure 4.8	Methane Recoveries by Thermal Stimulation (Ruppel 2011)	36
Figure 4.9	Methane Production Processes -1) Hot Water Injection, 2) Depressurization 3) Carbon Dioxide Injection (WOR 2014)	36
Figure 4.10	Depressurization Process (Ruppel 2011).....	37
Figure 4.11	Inhibitor Injection Process (Ruppel 2011).....	38
Figure 4.12	FTS Reaction in SBCR (Kim 2009).....	40
Figure 4.13	Block Diagram of Biomass to Liquid Process (Bellman 2007).....	42
Figure 4.14	Direct Liquefaction Process (Bellman 2007).....	42
Figure 4.15	Block Diagram for Direct Liquefaction Process (Bellman 2007).....	43
Figure 4.16	Process Flow Block Diagram of Indirect Liquefaction Process (Bellman 2007)	45
Figure 4.17	CeO ₂ Reticulated Porous Ceramic for the Solar Receivers (Furler 2012) ...	46
Figure 4.18	SOLAR Jet Reactor (Luftfahrt 2014)	47

Figure 4.19	Overall Setup of Solar Jet Reactor (DLR 2014)	48
Figure 4.20	Frontal Area of the Solar Jet Reactor (DLR 2014)	49
Figure 4.21	Overall Process Description of PTL Process (SunFire 2015)	51
Figure 5.1	Certification Process for Alternative Jet Fuels (IATA 2013)	53
Figure 5.2	Gas Turbine Fuel Approval Process (Rye 2010).....	54
Figure 5.3	Boiling Point Distribution of SPK Fuels (Moses 2008).....	58
Figure 5.4	Boiling Point Distribution for 50/50 Blend Fuels (Moses 2008)	62
Figure 5.5	Effect of Blending of JFTOT Deposit Characteristics (Moses 2008)	63
Figure 5.6	Density Distribution of 50/50 SPK Fuel Blends (Moses 2008)	64
Figure 5.7	SPK Fuel and its Blends Response Over Lubricity Improver Additive (Moses 2008)	65
Figure 6.1	Relationship Between LCA and Density for Different Types of Alternative Fuels (KTH 2014)	67
Figure 6.2	Generic Payload Range Diagram (Scholz 1999).....	68
Figure 6.3	Payload Range Diagram for Boeing 747-200B Flying with Distorted Hydrocarbon Fuel (Blakey 2011).....	70
Figure 6.4	Payload Range Diagram for Boeing 747-200B with Alternative Fuels (Blakey 2011)	71
Figure 6.5	Ethanol Powered Aircraft (Daggett 2006)	72
Figure 7.1	LCA for Bio Jet Fuel Production (Li 2014)	77
Figure 7.2	CO ₂ Equivalent Lifecycle Data for Range of Fuels (Blakey 2011)	83
Figure 9.1	Estimated Global Methane Emissions (Global Methane Initiative 2010) ..	88

List of Tables

Table 2.1	Energy Sources Available (Dry 1996)	14
Table 4.1	Possible Reactions in the FTS (Kim 2009)	39
Table 5.1	Common Test Methods Used for Jet Fuel Specification Testing (Greg 2006)	55
Table 5.2	Slopes of the Boiling Point Curves for the SPK Fuels (Moses 2008).....	59
Table 5.3	Thermal Stability of SPK (Moses 2008)	59
Table 5.4	Density and Freezing Point of SPK Fuels (Moses 2008).....	60
Table 5.5	Bending Point Curve Slopes for the 50/50 Blend Fuels (Moses 2008).....	61
Table 5.6	Thermal Stability of 50/50 SPK Fuel Blend (Moses 2008)	63
Table 7.1	Fuel Pathways for LCA (Wong 2008)	74
Table 7.2	Summary of Inputs and Results for F-T Jet Fuel from Natural Gas Pathway (Stratton 2010)	79
Table 7.3	Variation of Life-Cycle GHG Emissions with FT Process Energy Efficiency (Wong 2008).....	81
Table 7.4	Summary of Inputs and Results for F-T Jet Fuel from Biomass Pathway (Wong 2008)	82
Table 7.5	Life Cycle GHG Emission for the Different Fuel Pathways (Wong 2008) ..	84

List of Symbols

A	Area
CH ₄	Methane
CO	Carbon Monoxide
CO ₂	Carbon Dioxide
H ₂	Hydrogen
H ₂ S	Hydrogen Sulfide
I	Solar Irradiation
I _w	Wobbe Index
LCV	Low Calorific Value
m _F	Fuel Mass
m _{MF}	Maximum Fuel Mass
m _{MPL}	Maximum Payload Mass
m _{MTO}	Maximum Takeoff Mass
m _{MZF}	Maximum Zero Fuel Mass
m _{OE}	Operating Empty Mass
m _{PL}	Payload Mass
m _{TO}	Takeoff Mass
N	Nitrogen
nmi	Nautical Miles
O ₂	Oxygen
P	Phosphorous
P _{SOLAR}	Solar Radiative Power Intercepted by the Opening Area A
R 'COOR	Esters
ROH	Alcohols
SG	Specific Gravity
ΔH	Enthalpy

Greek Symbols

η _o	Petroleum Refinery Energy Efficiency
η _s	Energy Efficiency
χ	Product Relative Energy Intensity

List of Abbreviations

ASTM	American Society for Testing Materials
ATR	Auto Thermal Reforming
BBL	Barrel
BOCLE	Ball-On-Cylinder Lubricity Evaluator
BTL	Bio Mass to Liquid
CCS	Carbon Capture and Sequestration
CTL	Coal to Liquid
DCI	Corrosion Inhibitors
DEF STAN	Defense Standard
FAA	Federal Aviation Administration
FAME	Fatty Acid Methyl Ester
FT	Fischer Tropsch
FTS	Fisher Tropsch Synthesis
GHG	Green House Gas
REET	Greenhouse gases Regulated Emission and Energy in Transportation
GTL	Gas to Liquid
HVO	Hydration of Vegetable Oil
ICAO	International Civil Aviation Organization
IP	Institute of Petroleum
IPK	Iso Paraffinic Kerosene
ISO	International Standardization Organization
JP-8	Jet Propellant 8
LCA	Life Cycle Assessment
LCV	Low Calorific Value
LHV	Lower Heating Value
S-8	Syntroleum S-8 Jet Fuel
SBCR	Slurry Bubble Column Reactor
SG	Specific Gravity
SPK	Synthetic Paraffinic Kerosene
SSJF	Semi Synthetic Jet Fuels
STL	Sun to Liquid
WSD	Wear Scar Diameter
WTW	Well-to-Tank
WTW	Well-to-Wake

1 Introduction

1.1 Motivation

The demand for the fossil fuel keep on increasing every year but the sources are not the same, it is decreasing on the other side. This makes the fuel price to go high and forces the aviation to look for alternative solution. Commercial aviation is a global business for 15750 aircrafts currently operating on a single fossil fuel source and Airbus sources suggest that within 20 years there will be 31358 new aircraft deliveries around the world this aircrafts also depending on the fossil fuel supply.

Number of flights increasing every year this directly added up with the CO₂ emission. Aviation industry contributes 2%...3% of global CO₂ emission and it is going to increase in the coming years. By considering all the above problems, aircraft industries are looking for the alternative fuels to fly their aircraft without modifying the structure and the engine. Bio fuels and synthetic fuels can be an option for this. For using the bio fuel and synthetic fuel, only minor changes in the aircraft engines and fuel tanks needed. When using these fuels as a blend with the kerosene there is no need of any changes in the aircraft.

This Project report focuses on the alternative fuels, which are in current trend all around the world and analyzing which alternative fuel has the close properties to fossil fuel and their availability around the world. LCA of the alternative fuels carried out with the sources available from internet to find the GHG emissions. Life cycle assessment of alternative jet fuel includes the complete fuel cycle. This includes the process of Growing plants, all kind of transportations, production of fuel from the feedstock, combustion of fuel in the aircraft. This analysis process also known as "Well to Wake"

1.2 Objectives

The whole content of the thesis explains the different alternatives fuels. By analyzing the production methods, sources available in nature, Green house gas emission and the cost of production a suitable alternative fuel chosen from the various fuel options. Certification process for the fuels and test results produced from the airliners compared before coming to a decision.

1.3 Structure of this Project

The whole project report consists of six chapters. In detail, description of the chapters follows:

Chapter 2	Gives a short introduction about the alternative fuel options and fuel demand and green house gas emissions.
Chapter 3	Describes the different sources for bio jet fuel and production methods, chances in the aviation industry.
Chapter 4	Explains the different kind of synthetic fuels, its production methods, and the details about the sources and the chances to fulfill the supply demand
Chapter 5	Certification processes for the alternative fuels
Chapter 6	Aircraft design details for the alternative fuels and performance comparison with the conventional jet fuel
Chapter 7	Life cycle assessment of the alternative fuels
Chapter 8	Flight tests done with the alternative fuels by different aircraft carriers
Chapter 9	Overview about the environmental impacts due to improper use of alternative fuel natural resources
Chapter 10	Thesis conclusion
References	Sources referred to write the Master thesis mentioned in a proper format

2 Background

Lot of research projects and sources shows that the new sources for fossil fuel keep on decreasing meanwhile the need of oil is increasing. These results warn Aviation transport cannot only rely on the fossil fuel.

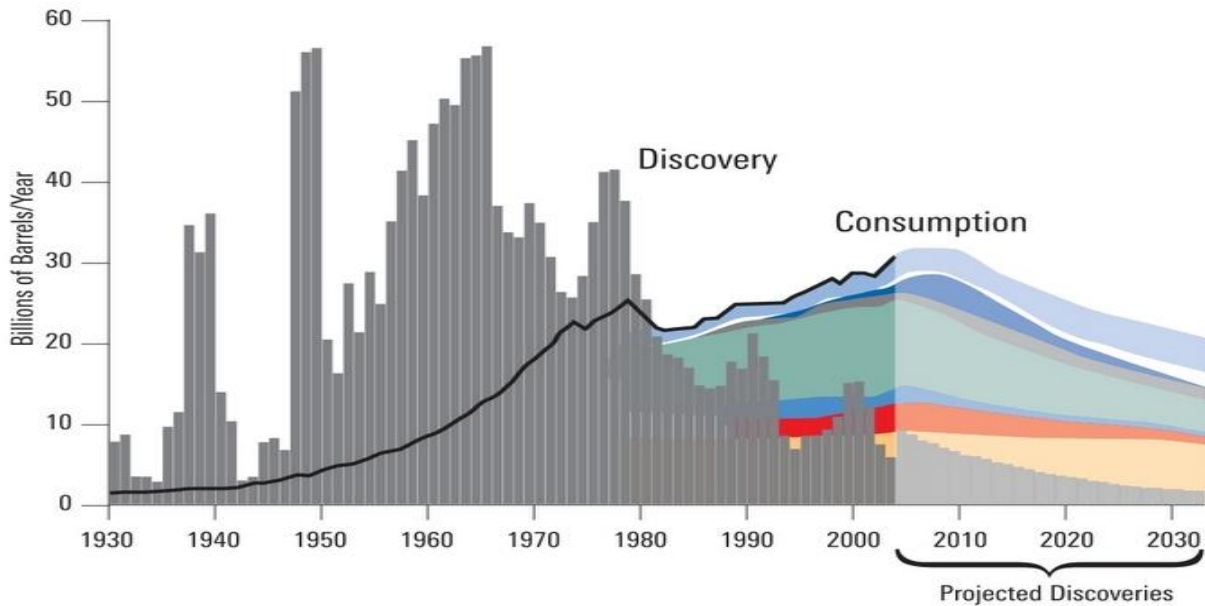

Figure 2.1 Oil Discoveries: Oil Discoveries Decreasing and Consumption Increasing (Campbell C.J 2006)

It is clear that fuel price keep on increasing because of the lack of fossil fuel sources. This is the right time to find and adapt with the alternate fuels options.

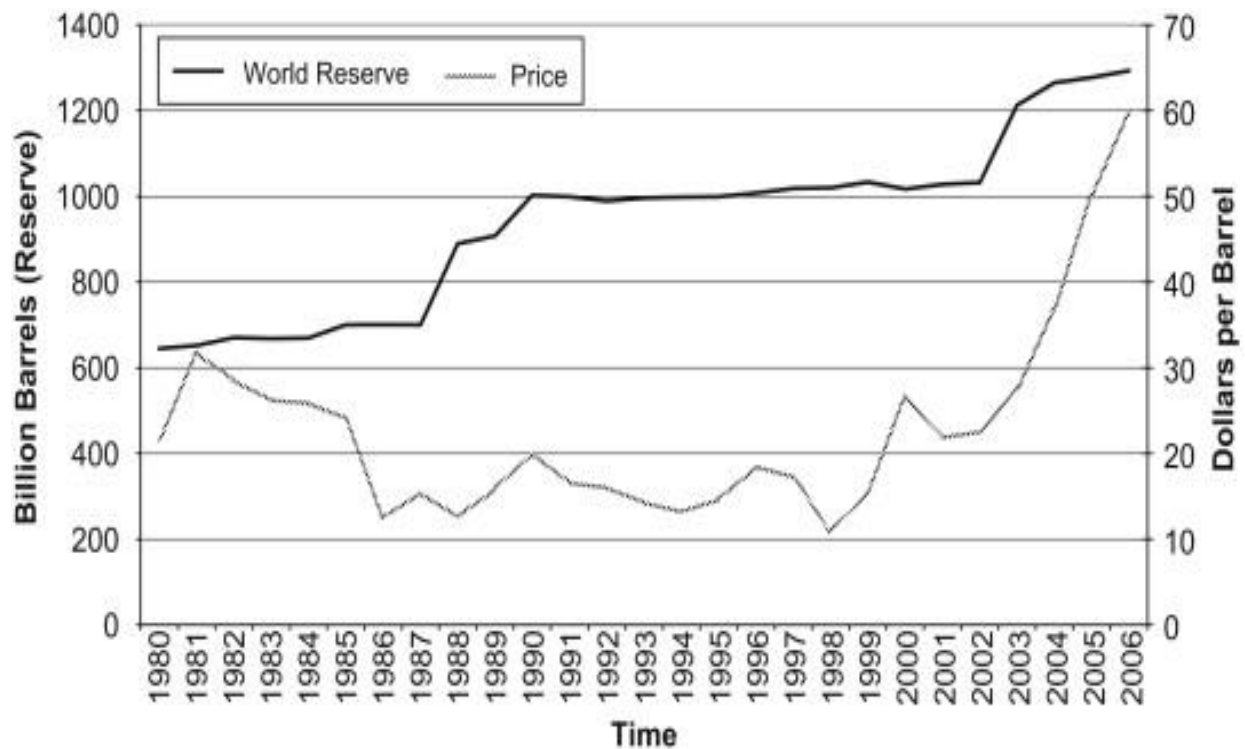

Figure 2.2 World Oil Reserve and the Dollars per Barrel in Years (1980-2006) (Shafiee 2009)

Table 2.1 Energy Sources Available (Dry 1996)

Source	Reserve (10^9 bbl Oil Equivalent)	Life Time (Years) (40×10^9 bbl One Year Energy Demand)
Tar Sands	1500	40
Oil	2000	50
Shale	2500	65
Gas (Methane)	3000	75
Coal	53000	1300

Table 2.1 explains the different energy sources available in bbl and the life of the sources in years (Dry 1996). Modern aircraft are well developed to save fuel in the last 40 years. Over the 40 years, the aviation industry reduced fuel consumption and CO₂ emissions 70%, NO_x emissions 90% and noise reduction by 75% (Dry 1996). In the future, it is possible to save 10%...15% more fuel with the use of composite materials and modified engines and new design. This will help to move on with the fossil fuel for few more years but there are no possibilities to protect environment. From the latest results of ICAO international passenger traffic shows growth of 5.2% and the domestic passenger traffic shows growth of 5.1% in 2013 (Airbus 2007). This result shows the fuel necessity will increase continuously in the coming years. Only solution readily available now, to maintain the fuel demand, cost and to reduce CO₂ emission is to start using bio fuel and synthetic fuel as an aircraft fuel.

Commercial aviation is a global business for 15750 aircrafts currently operating on a single fossil fuel source. It contributes 2%...3% of global CO₂ emission. Aviation global traffic keep on increasing every year, this forces the industries to look for alternative fuel. By 2033, the fleet of passenger aircraft (with 100 seats or more) and freighter aircraft (10 tones or greater), will be 37463 aircraft, more than doubling the fleet in service today (ICAO 2013).

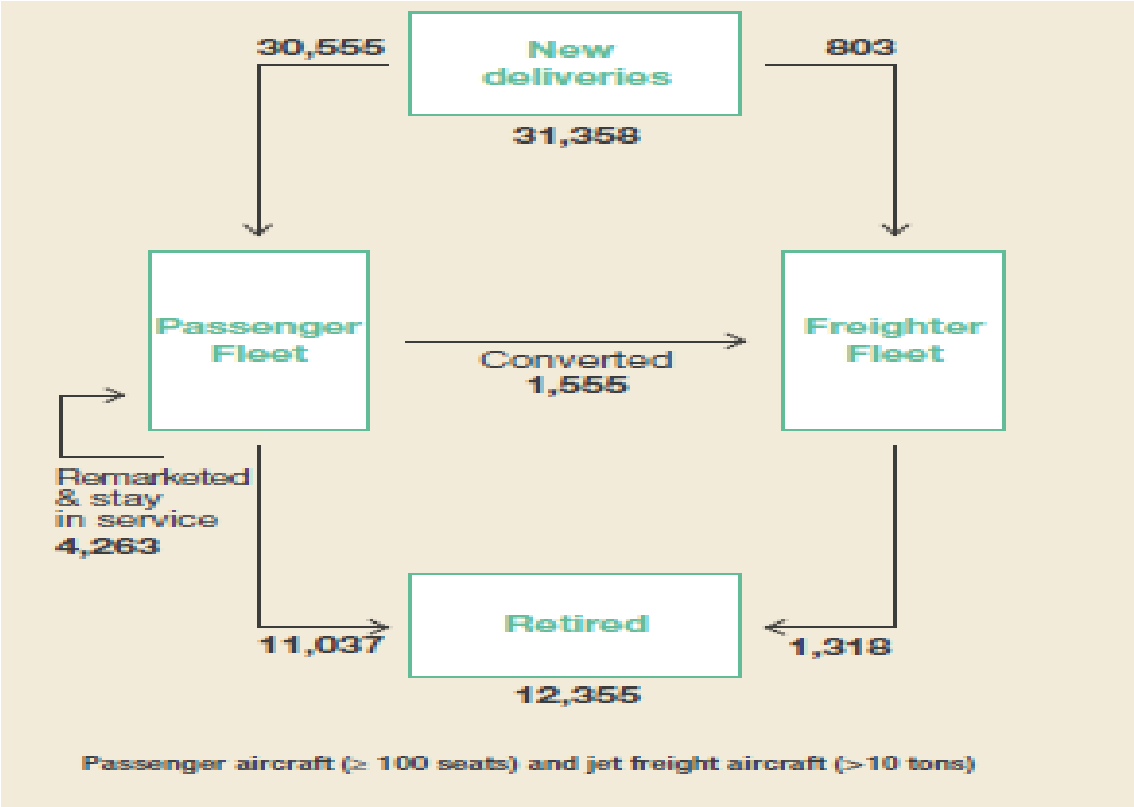

Figure 2.3 Demand for more than 31000 New Aircraft (ICAO 2013)

SINGLE-AISLE: 70% OF UNITS;
WIDE-BODIES: 55% OF VALUE
 Source: Airbus

GMF 2014

20-year new deliveries of passenger and freighter aircraft

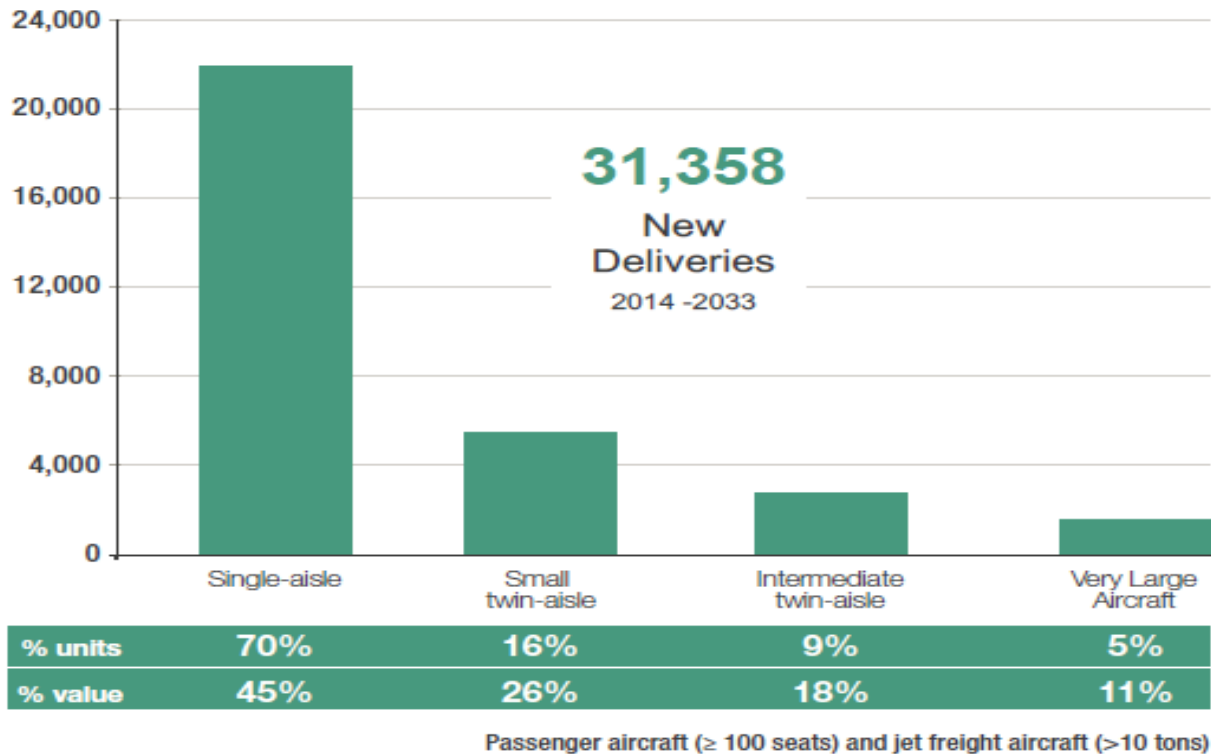

Figure 2.4 Number of New Deliveries Based on the Size of the Aircraft (ICAO 2013)

By considering the different types of solutions to reduce the CO₂ emission chart is prepared between the industry target and CO₂ emission from 2010...2050. When considering the operational improvements and infrastructure improvements doesn't help to reduce the CO₂ emission, because in 40 years air traffic is going to get doubled so there is possibilities to reduce emission with the help of operational and infrastructural improvements. Next possible cases improving aircraft efficiency and early retirement of aircraft, of course this will reduce the CO₂ emission slightly but this will not lead us to the target. The only option, which lies closer to the industry target, is bio fuels and synthetic fuels.

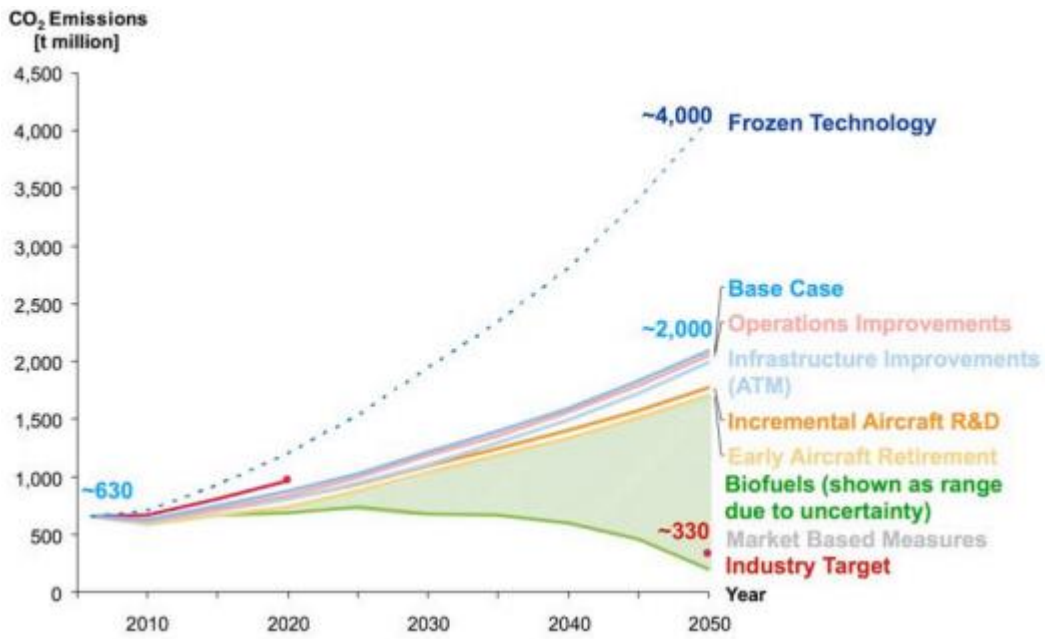

Figure 2.5 CO₂ Emission in 2050 by Considering Different Possible Measures (Marsh 2008)

3 Bio Fuel

3.1 Bio Fuel from Plants

The sources to produce bio jet fuel are plants with sugars and starch, oil. The sources for the vegetable oil are palm oil, soya oil, corn, switch grass, jatropha oil, camellia oil are suitable for producing bio jet fuel (**Marsh 2008**). There is a special process involved to convert the oil into bio jet fuel this processing involves hydro treatment to deoxygenate the oil with subsequent hydro cracking to create hydrocarbons that fill the distillation range of jet fuel. From the above listed sources of the oils there are some edible items included use of these sources to produce fuel need millions of acres of fertile cropland. This creates lot of direct or indirect problems in environment and affects food price. To produce enormous amount of fuel more land needed for this deforestation and leaving behind the other food crops and only cultivating the fuel crops may occur. If this happens this will result in more CO₂ emission and food products price goes higher. Therefore, rules need to control this measures (**Stratton 2010**).

3.1.1 Analyzing Sources for Bio Jet Fuel Production

3.1.1.1 Jatropha Curcus

Jatropha curcus is a small plant with can grow up to 5...7 meters and the suitable environment for growing is rainfall regions and it is inedible. Normally it gives flowers and seeds once a year during the rainfall season but with perfect climate and humid conditions, it gives the product through the whole year (**Achten 2010**). The fruit has an outer shell and inside it has 2...3 seeds. When compared to other plants Jatropha seed have a higher oil yields. The oil from the seed can be extracted easily and with the cheap and simple technology.

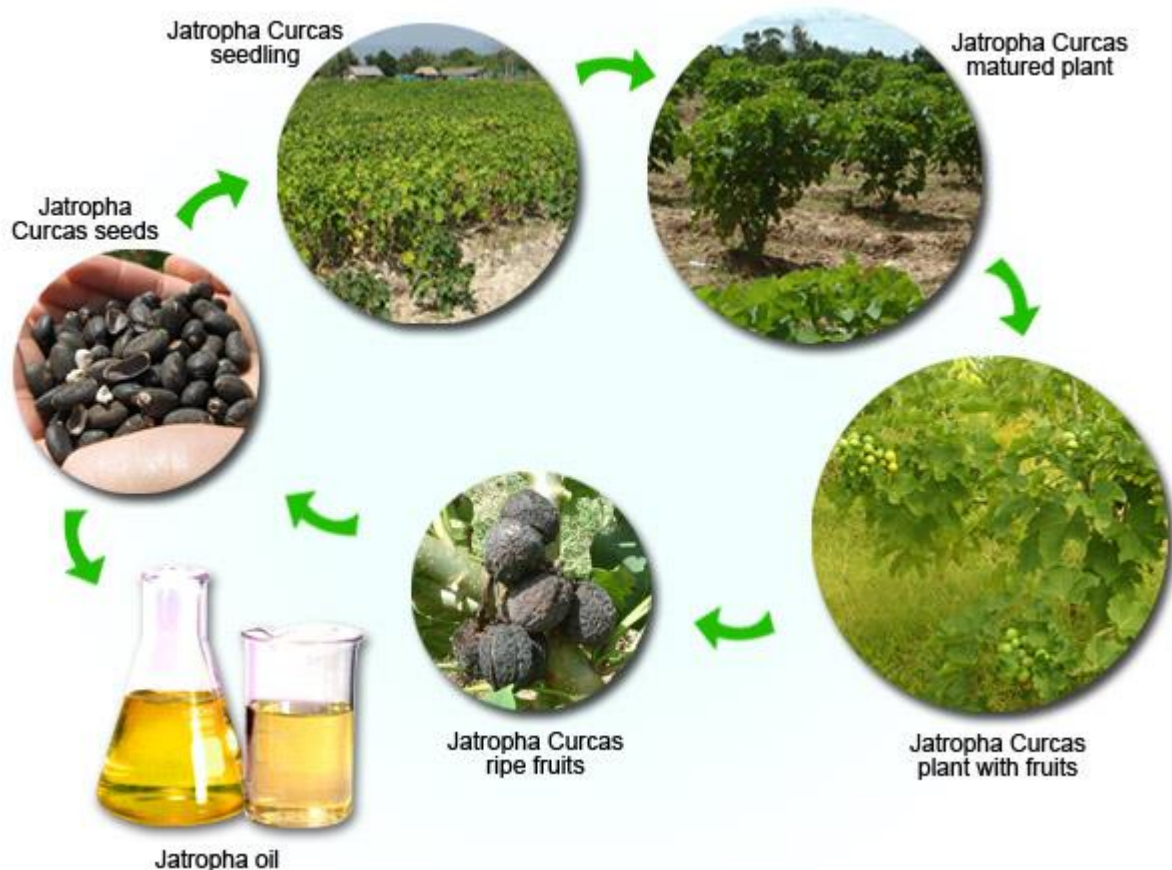

Figure 3.1 Jatropha Curcas with the Seeds (Bionas 2011)

Other than the fuel, production we can use Jatropha trees for other purposes also, planting at the borders of the crop field will act as a fence giving protection from animals. The bark of Jatropha curcas gives a dark blue yield a dark blue dye, which is reported to be used in Philippines for colorings cloths and finishing nets and lines (Gübitz 1999). The tree can be planted in the slope regions to protect the soil erosion and to increase the quality of the soil.

3.1.1.2 Palm Oil

Palm oil one of the most used oil for the cooking purposes also in the food industries. Due to the low cost palm oil is now considered as the source for alternative jet fuel. Main countries for the palm oil resources are Indonesia and Malaysia. However, due to the limited land availability these countries can't increase their production. However, West Africa is now considered suitable place to produce palm oil for the fuel production. Indonesia is responsible for 45 percent of the world palm oil production and Malaysia producing around 40 percent in the world production. Other countries suitable for palm oil production are West Africa, Thailand, Papua New Guinea, the Philippines, India and Cambodia (Dekel oil 2014). Palm oil is an important feedstock used to produce bio fuel. It has a higher yield per acre than other feedstocks – twice as of coconut, five times that of rapeseed and 12 times that of soybean.

Palm oil has the lowest per unit production costs of all vegetable oils and the extraction process is robust and simple.



Figure 3.2 Palm Oil Seeds and Palm Trees (Dekel oil 2014)

3.1.1.3 Soya Oil

Soybean oil is one of the major feedstock for the bio fuel production. Soybeans contain approximately 18 percent of oil (Soybean 2014). USA alone produced 37 percent of soybean oil in the world remaining at the top position. The USA was followed by Argentina, China, Brazil and India in production (USDA 2012). Soybeans and corn planted in the same soil. It grows in a cyclic manner in the corn or wheat fields. This helps to neutralize the land conditions also helps to protect the crops from the insects and from the diseases. Soya oil produces the bio fuel and Ethanol. The remaining hulls from the soybean used to feed the animal because of its high protein. Before the oil extraction, it has to be treated by cleaning and drying, de-hulling and grinding. After the initial preparation, there are lots of methods to

extract oil from the soybeans. Use of mechanical presses, solvent extraction, supercritical fluid extraction, microwave and ultrasound assisted oil extraction these are some methods followed for extraction of oil.

3.1.2 Bio Fuel Production- Transesterification

Transesterification is the process of producing bio diesel from the vegetable oil with an alcohol to form glycerol and esters. Catalyst also involved in this process. Mainly transesterification is used reduce the viscosity of the oil which is higher than the normal fossil fuel. This process of is a reversible process to mange and shift it towards the resultant side excess alcohol is added. It is very important to choose the alcohol for the process. Many varieties of alcohol are used. Such as methanol, butanol, ethanol, propanol and amyl alcohol used for transesterification. Methanol is used widely because of it low cost than other alcohols and has chemical and physical advantages over other alcohols (**Gupta 2010**). If methanol used for the reaction than the process is called methanolysis. The common reaction equation is below.

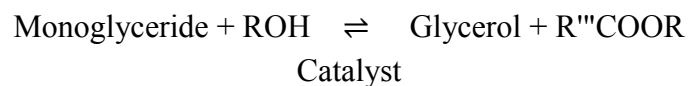
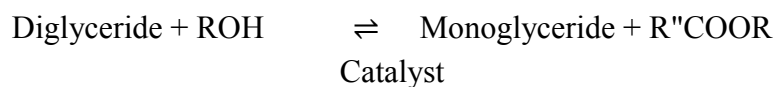
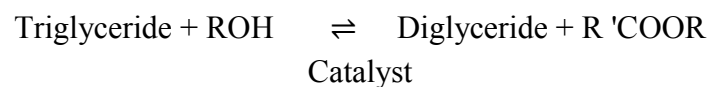

In the transesterification process, the triglyceride reacts with alcohol in the presence of a catalyst, normally a strong alkaline. The alcohol reacts with the fatty acids to form the mono-alkyl ester, or biodiesel, and crude glycerol. Potassium hydroxide is suitable catalyst for the Ethyl Ester biodiesel production. The figure below shows the chemical process for methyl ester biodiesel.

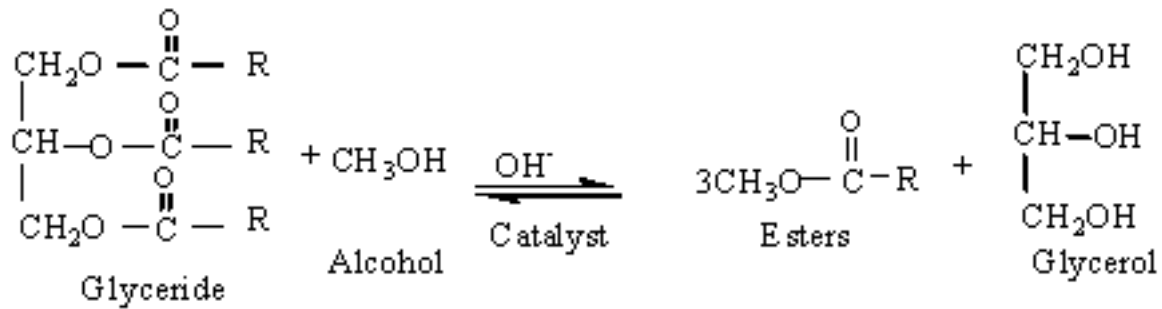

Figure 3.3 Transesterification Process (USDA 2010)

Simple flow chart shown in Figure 3.4, which consists of all the process, involved in the production.

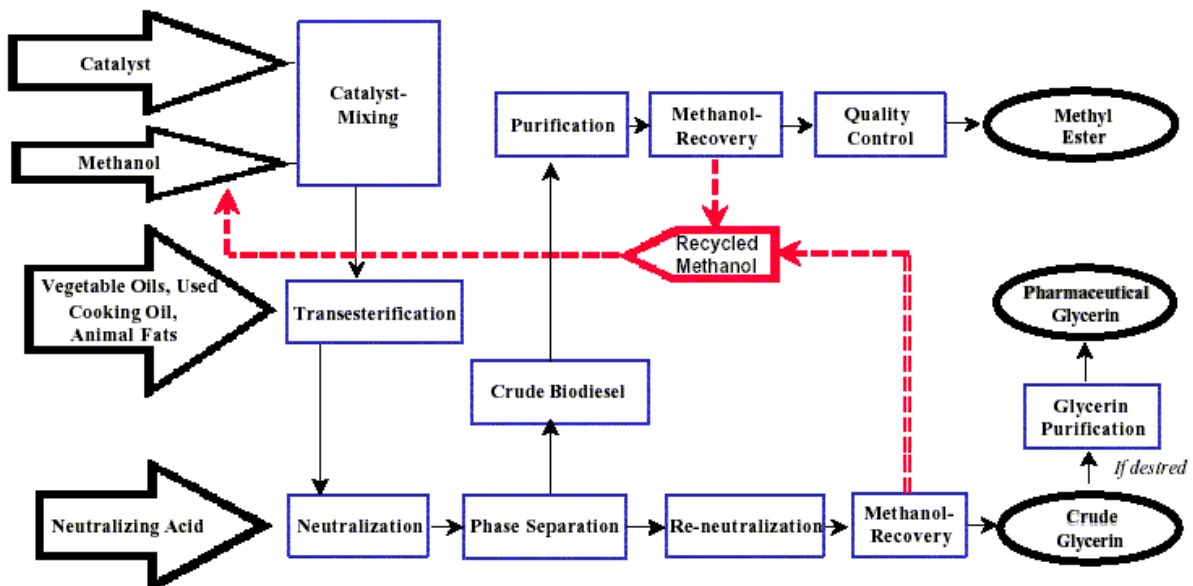

Figure 3.4 Production Process (USDA 2010)

Usually, sodium hydroxide or potassium hydroxide used as catalyst. Then the catalyst is mixed with the alcohol. In the closed environment, vegetable oil is added with the alcohol and catalyst mixture. This mixture is kept closed at a temperature of 160 °F to speed up the reaction. Reaction time varies from one to 8 hours. Before adding the vegetable oil, water content and free fatty acid levels in the oil has to be measured carefully. Excess amount of water and fatty acids will cause problems like soap formation and the separation of glycerin. After the reaction finish, the main two resultants are glycerin and bio fuel. Both the resultants have unused methanol from the reaction it can be removed later. Glycerin has high density when compared with the bio fuel, so it can be separated by the use of gravity were the high dense get settled down at the bottom and low dense remains at the top. In addition, centrifugal force used to make it faster (USDA 2010).

3.2 Bio Fuel Production from Microorganisms - Algae

Bio fuel from microalgae is produced along four main process steps: cultivation, harvest, extraction of raw material and conversion to fuel.

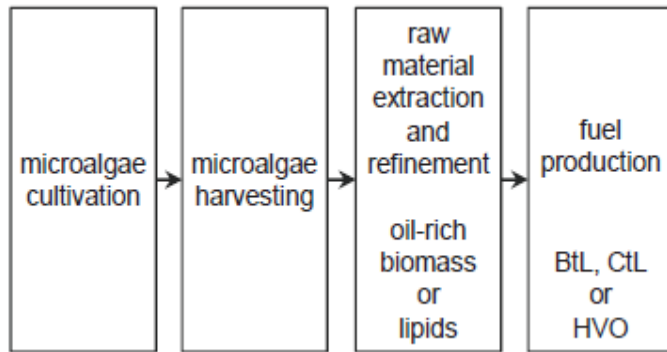

Figure 3.5 Algae Bio Fuel Production Process (Gehrer 2014)

Producing micro algae is more costly than growing conventional crops. For the photosynthesis algae requires light, water, carbon dioxide, organic salts and temperature has to be maintained from 20⁰ to 30⁰ Celsius. In order to reduce the production cost light source can be sun light but it has to be same around the year. In addition, the growth medium water has to supply the essential inorganic elements. The elements are nitrogen, phosphorus, iron and sometimes silicon. This amount of inorganic elements can be reduced by choosing suitable molecular formula for the algae biomass (Yusuf 2007). Grobbelaar 2004 found out this Algae nutrition formula $CO_{0.48}H_{1.83}N_{0.11}P_{0.01}$. Phosphorous must be supplied in excess because phosphorous can form connections with metal ions hence, it can't be used by the algae. For the marine algae, growth seawater is supplied with nitrogen and phosphate fertilizers and other micronutrients. In this case, the growth medium seawater is inexpensive and with nutrients, this reduces the production cost and energy.

Micro algae biomass approximately contains 50% of carbon after it is completely dried (Yusuf 2007). This biomass is totally from carbon dioxide. Photosynthesis process needs supply of carbon dioxide continuously. If the processing plant of biomass is, built next to the algae production area the carbon dioxide emitted during the processing can be supplied to the algae. This will result reduction in net carbon dioxide emitted in the atmosphere during the whole process. Production of algae is a continuous process during the sun light. The fresh growth medium is supplied and the bio mass is extracted continuously. During the night, supplying fresh growth medium is stopped but mixing is done continuously to prevent biomass settling down at the bottom. During the night because of respiration process of algae, around 25% of the biomass produced during the daytime is lost. This level of loss is depending on the day light level and temperature during daytime and temperature during nighttime (Molina Grima 1999).

3.2.1 Production Methods

There are different types of production methods. Only two methods are suitable for the large-scale production.

1. Raceway ponds
2. Tubular photo bioreactors

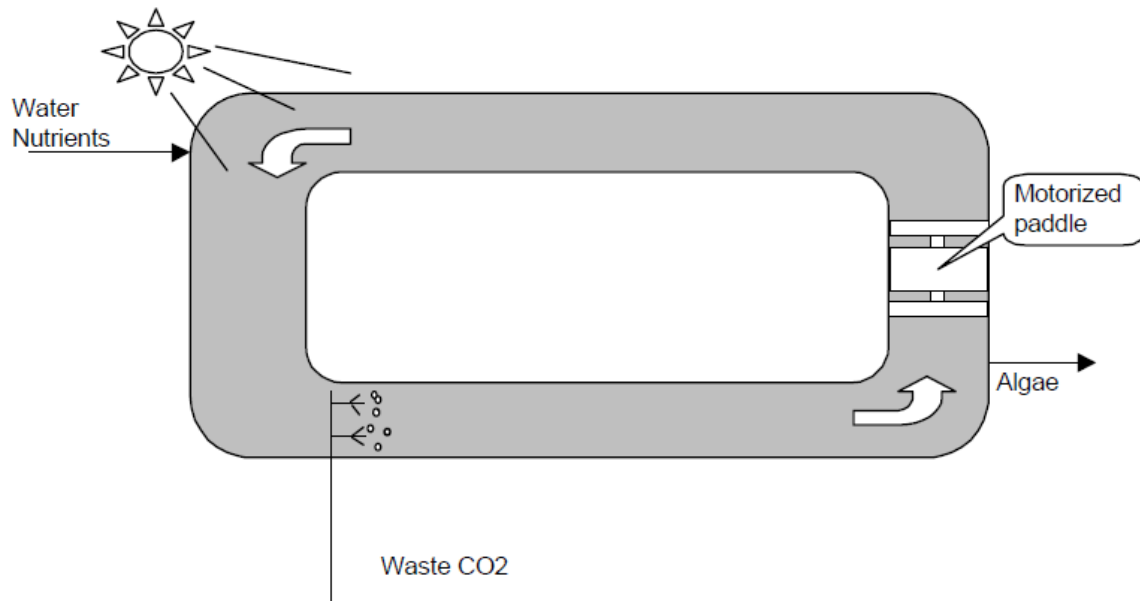

Figure 3.6 Raceway Ponds (Nrel 1998)

3.2.1.1 Raceway Ponds

Figure 3.6 shows the arrangement of raceway pond. In the raceway ponds algae, water and nutrients keep on flowing around the track with the use of motorized paddle wheels. By the continuous mixing algae circulated from the bottom to the top level of water on a regular frequency. The ponds limited in depth in a way such sun light can reach the bottom of the pond. The total system run continuously by supplying adequate water, nutrients and the other side algae biomass is also removed continuously. Some kind of special technique required to remove the biomass from the system. This biomass contains water and algae together. Algae removed from the oil. It is possible to use the Raceway pond production method in a large-scale production system. A sample for such method is shown in Figure 3.7. The productivity of the system is the estimate of biomass produced in a day from the available surface area. There are many sources for the CO₂. The main power source for the entire system can be produced from burning fossil fuel or coal. CO₂ emitted in the system can be used effectively. In raceways, evaporative loss of water is quite significant. Because of the losses to atmosphere, the use of carbon dioxide supplied is quite bad. In addition, the productivity gets

affected by unwanted algae and microorganisms, which present in the atmosphere. Raceway production method is less expensive than the photo bioreactor. However, the productivity of raceway ponds is low compared with the photo bioreactors (Yusuf 2007).

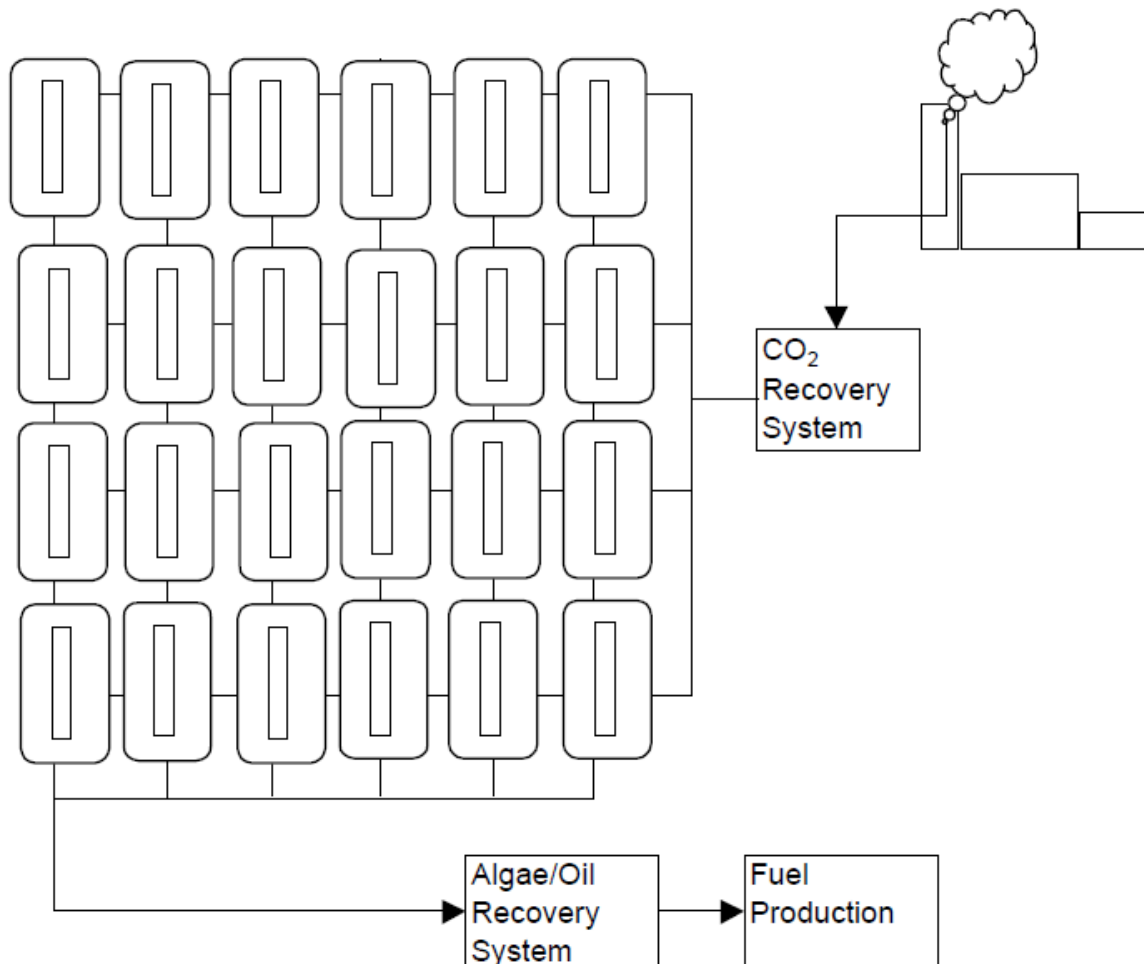

Figure 3.7 Large Scale Production Farm (Nrel 1998)

3.2.1.2 Photo Bioreactors

The photo bioreactors are completely closed one so it is possible to grow single algae species for long durations. By using this production method, it is possible to produce large amount of biomass (Molina Grima 1999). There are different types of tubular arrangements present, it depends on the area available. This setup consists of tubular photo bioreactor made up of plastic or glass and placed in an array. This transparent tubular array used to capture the sunlight. Figure 3.8 shows the model setup of tubular arrays. The size of the tube varies usually from 0.1 meter and less. This size is suitable for capturing the sunlight effectively. The medium is circulated continuously so the produced biomass can be removed instantaneously and the fresh medium and carbon dioxide can be added at a regular interval of time. This setup requires huge surface area. To minimize the surface along with the effective use of sunlight a new arrangement called "fence" is used. Figure 3.9 shows the fence setup.

This setup is useful where the area is too limited. Photo bioreactor tubes are always arranged along South to North. This helps to capture the sunlight effectively from East to West. The bottom surface of the bioreactors are painted or covered with white in order to reflect the sunlight effectively.

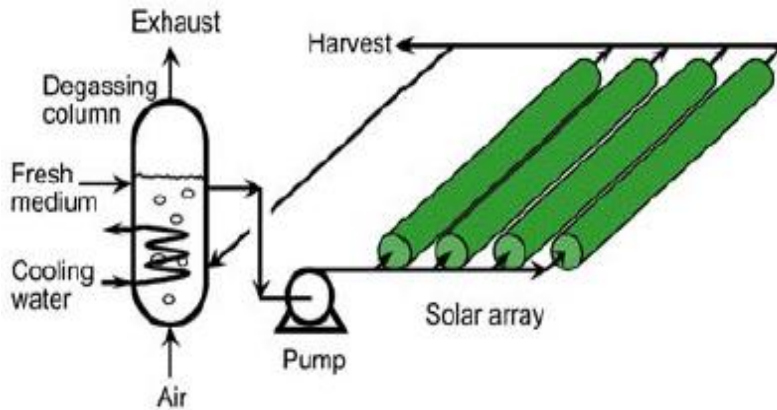

Figure 3.8 Tubular Photo Bioreactors in Horizontal Setup (Yusuf 2007)

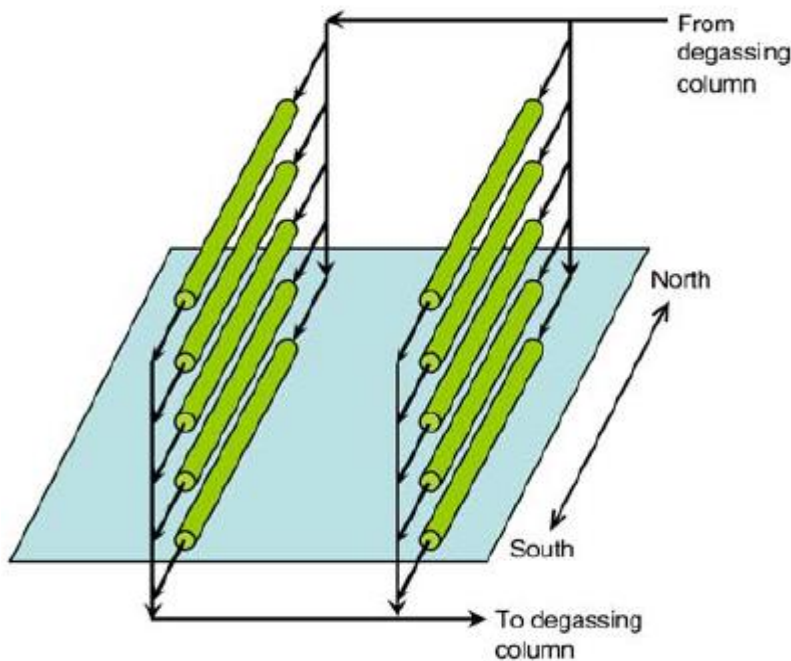

Figure 3.9 Fence Arrangement (Yusuf 2007)

In addition, these tubes can be made up of flexible material and coiled around some support to form a helical structure. However, these helical bioreactors can't be used for mass production. Figure 3.10 shows the helical arrangement of bioreactor tube. There are several other types of arrangements available but it's not used in mass production. Biomass sedimentation can occur along the tubes to prevent this flow inside tubes highly turbulent. Mechanical pumps or airlift pump generates this flow. Mechanical pumps are easy to install and operate.

However, sometimes these mechanical pumps can damage the biomass. Airlift pumps not flexible as mechanical pumps and requires air supply to operate. At regular interval photo bioreactors must be cleaned this can be done by automated clean in place operations.



Figure 3.10 Helical Bioreactor Arrangement (Yusuf 2007)

3.2.2 Biomass Recovery

There are three common methods used for biomass harvesting,

1. Centrifugation
2. Filtration
3. Gravity sedimentation

Generally, biomass looks like a paste. It requires one or more solid and liquid separation steps. Recovery of biomass is one of the biggest problems in algae bio fuel production. Algae size is the main problem it generally varies from 3-30 μm diameters (Molina Grima 2003). Culture broth are very dilute ($< 0.5 \text{ kg /m}^3$) so huge volume has to be processed to separate the biomass from the system. There is no single method suitable for separation of biomass from the broth. Biomass recovery itself cost around 20-30% in the total production cost. Filtration and sedimentation process are very slow and can't suitable for the industrial production. Centrifugal separation is relatively fast way to recover biomass and effective one. In addition, the separation method is chosen based on the moisture content allowed in the biomass after that process. The excess level of moisture will affect the next following steps in

bio fuel production. Gravity sedimentation process is more dilute when compared to the centrifugal process. If dehydration of the biomass is needed to remove water from it then thermal drying method is used. Nevertheless, thermal drying process needs lot of energy when compared to the mechanical processing. Therefore, it is better to do thermal processing after the centrifugal processing or any other primary process (Molina Grima 2003). Figure 3.11 shows algae biomass recovered.



Figure 3.11 Biomass Recovery (Yusuf 2007)

3.2.3 Energy Extraction from Algae Biomass

Based on the initial condition of the biomass (wet or dry biomass) energy extraction process is categorized into two (Milledge 2014).

1) Energy extraction methods for dry biomass

- i. Direct Combustion
- ii. Pyrolysis
- iii. Gasification (Conventional)
- iv. Transesterification to Biodiesel

2) Energy extraction methods for wet biomass

- i. Hydrothermal Treatments
- ii. Fermentation to Bioethanol or Biobutanol
- iii. Anaerobic Digestion

4 Synthetic Fuel

Normally synthetic fuels are derived using the Fischer-Tropsch (FT) synthesis. The sources to produce synthetic fuels are coal, natural gas and biomass. Already CTL (coal to liquid) and GTL (gas to liquid) have been implemented successfully in industrial level production. BTL (biomass to liquid) is still in laboratory testing level. A latest finding in the synthetic fuel technology is STL (sun to liquid). Solar power used to crack the carbon dioxide and water molecules to form syngas ($\text{CO}+\text{H}_2$). This syngas is fed in to the FT reactor to produce synthetic fuel. In all the four different sources, only the initial syngas production method varies, the step followed by the syngas production is almost the same.

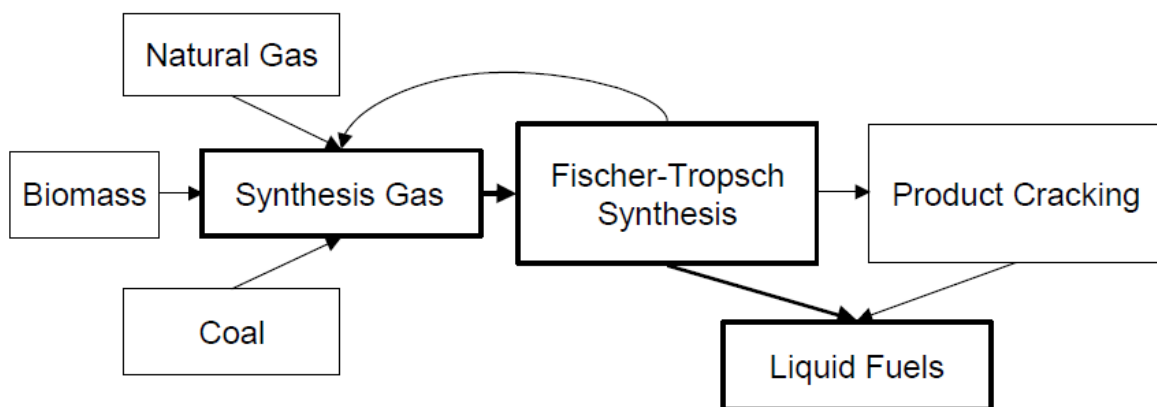

Figure 4.1 Overall Process for Synthetic Fuel Production (Ronald 2004)

4.1 Gas to Liquid

GTL have already in use on commercial fuel industry and the technology is well developed. Gas to liquid plant consists of two main processing plants. One is to convert the natural gas CH_4 into the syngas. Syngas is the mixture of CO and H_2 . Then this syngas is fed into the FT reactor. FT process plant produces the synthetic fuel from this syngas. ATR (auto thermal reforming) is the syngas production unit and slurry phase reaction with catalyst in FTS unit; these are the two main reaction units. The production of syngas is very expensive process. In the whole production process syngas production itself amounts 70% of capital cost (Dry 1996).

4.1.1 Natural Gas Resources

Amount of methane trapped in methane hydrates are huge. Methane hydrates are an unusual sedimentary mineral that formed in the continental shelf areas, permafrost regions, and marine sediments of the world. A hydrate is a chemical or mineral that contains water, bound with its chemical structure. Methane hydrate is formed by methane (CH₄) bound with water (H₂O) molecules. General formula for the methane hydrate is CH₄.n H₂O, 'n' describes the variable number of water molecules (Lonero 2008). Figure 4.3 shows the locations of the methane hydrates around the world (Smith 2011). This makes it easy to access and produce fuel around the world.

Methane can be separated from the hydrates and it can be used to produce synthetic jet fuel by the GTL (Gas to Liquid) process.

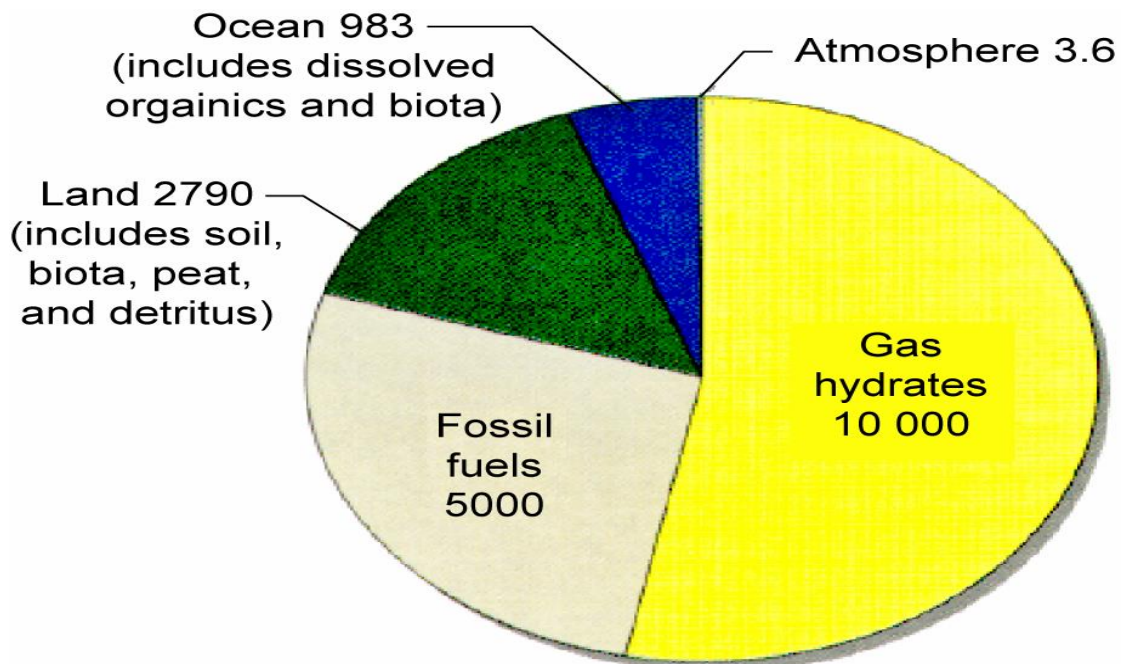

Figure 4.2 Distribution of Organic Carbon in Earth Reservoirs (Excluding Dispersed Carbon in Rocks and Sediments) Numbers are in 10¹⁵ Tons of Carbon (NOAA 2001)

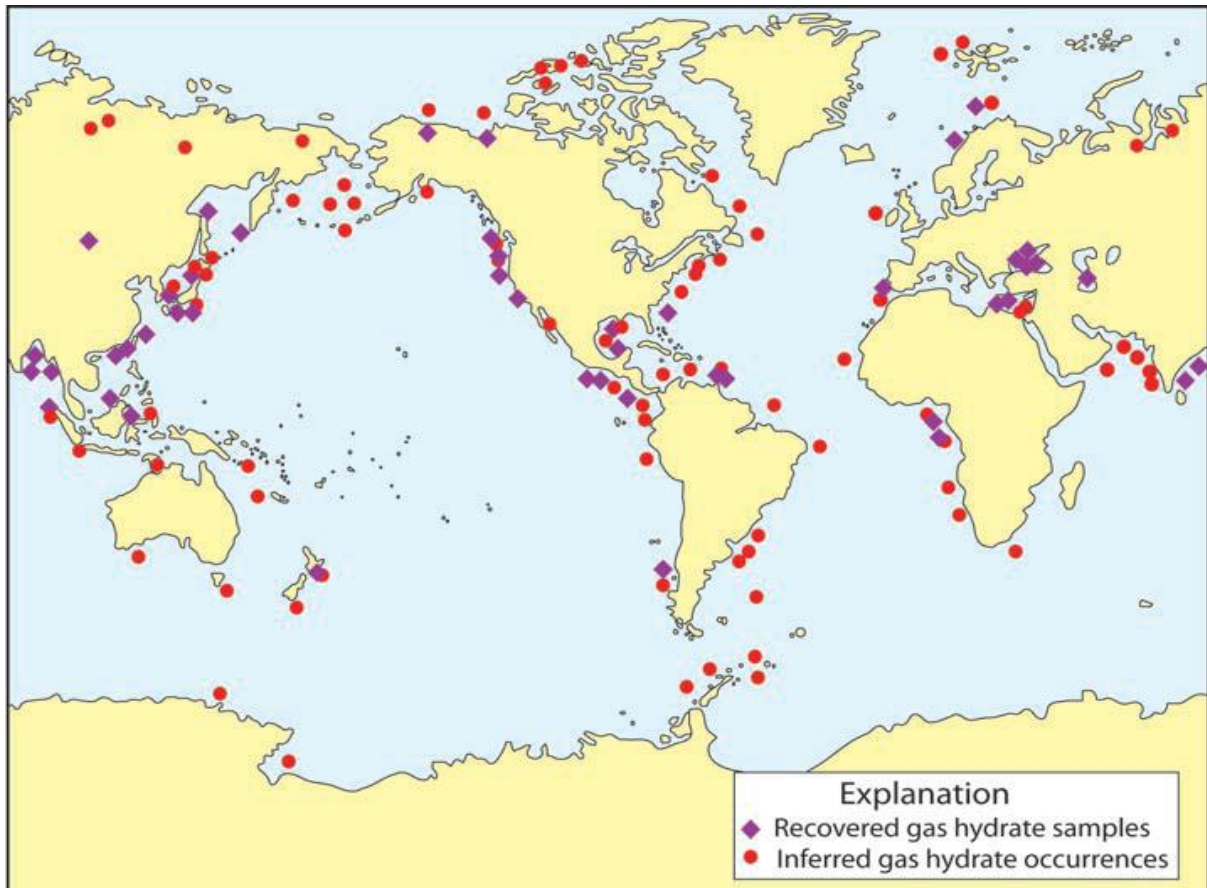

Figure 4.3 Locations of the Methane Hydrates all Around the World (**Smith 2011**)

4.1.2 Methane Hydrate

4.1.2.1 Methane Hydrate Properties

Methane hydrate is a natural substance in which a host lattice of water ice encloses guest molecules of methane. Methane contains one carbon and four hydrogen atoms (CH_4), is the simplest hydrocarbon molecule and the main substance of natural gas. Figure 4.4 shows the molecular arrangement of methane hydrate (**Smith 2011**). In methane hydrate, methane and water molecules are not chemically bonded; simply gas molecules are trapped within the crystalline lattice. It looks like a natural white ice, but its properties are different. When this methane hydrate is melted or when it is placed under the pressure and temperature at which it is not stable then the water melts and the trapped methane released.

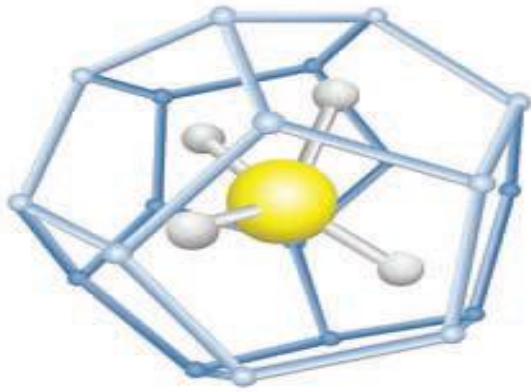

Figure 4.4 Model of a Methane Hydrate Molecule (**Smith 2011**)

Figure 4.5 shows the burning methane, which comes out from the methane hydrate when it is ignited with some external heat sources. Due to heat, water goes away and methane catches the fire. This process is also known as dissociation (**Smith 2011**).



Figure 4.5 Burning Methane from Methane Hydrate (**Smith 2011**)

4.1.2.2 Methane Hydrate Formation and Stability

Based on the U.S. Geological survey, the organic carbon content present in the methane hydrates worldwide is estimated around 104 Giga tons. This amount is roughly twice the amount of carbon present in all the fossil fuels combined together. Methane hydrates need special temperature and pressure conditions to get formed naturally. That is temperature around 5°C and high pressure 27.6 bar this pressure can be measured at 500 m depth of water. They must have settled down with the organic remains, from this bacteria have produced generated. This rapid transformation protects it from oxidation (**Mushtaq 2012**).

The stability curve in Figure 4.6 shows the relation between the temperature and pressure for the formation of methane hydrate. It shows at low pressure also formation is possible if the temperature is very low and in case of high pressure stability is possible at high temperature.

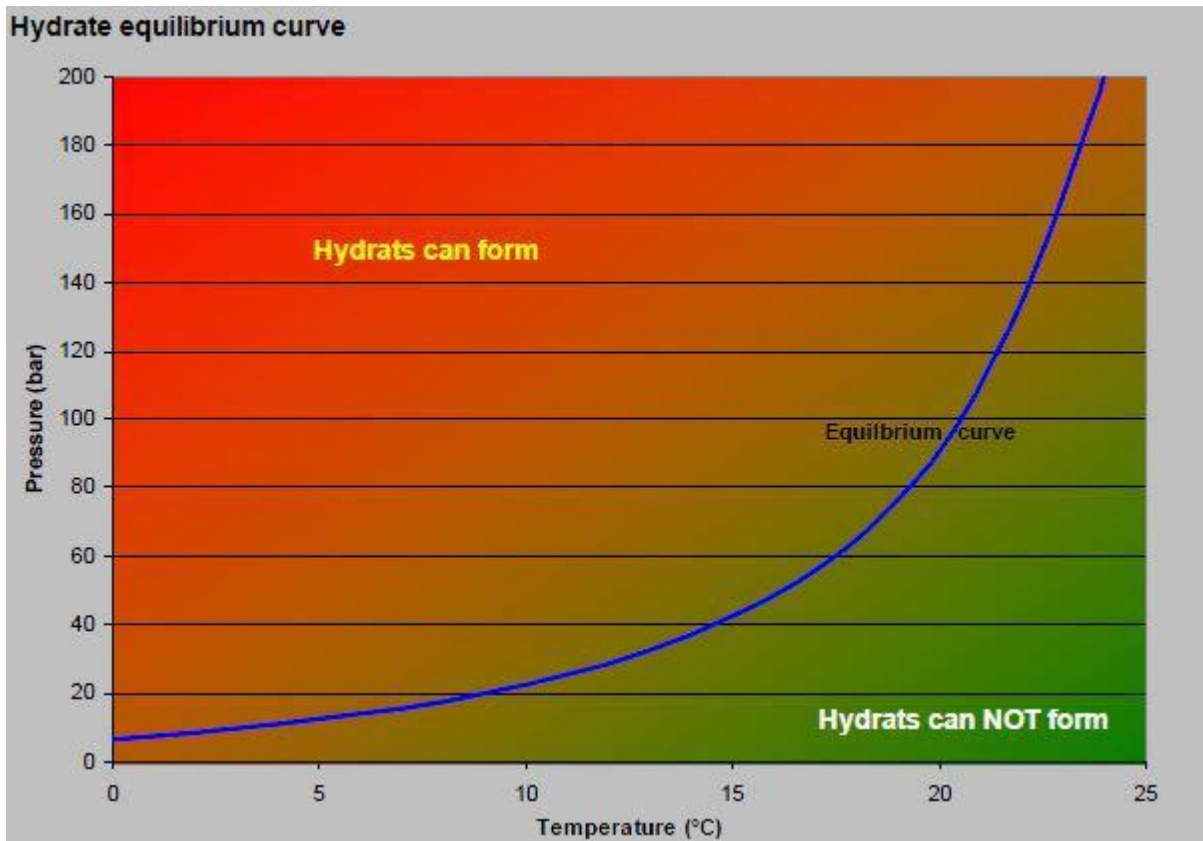

Figure 4.6 Hydrate Phase Diagram (Mushtaq 2012)

Figure 4.7 is a phase diagram showing the pressure and temperature ranges where methane hydrate is stable. The horizontal axis shows temperature, increasing from left to right, and the vertical axis shows depth of hydrate source, increasing from top to bottom. Because fluid pressure increases with depth below the surface of the earth or the ocean, depth serves an important role in hydrate phase diagram. The curved line is the phase boundary. Above this line, formation of hydrate is not possible and below this line there are possibilities for the formation of hydrates and it is stable.

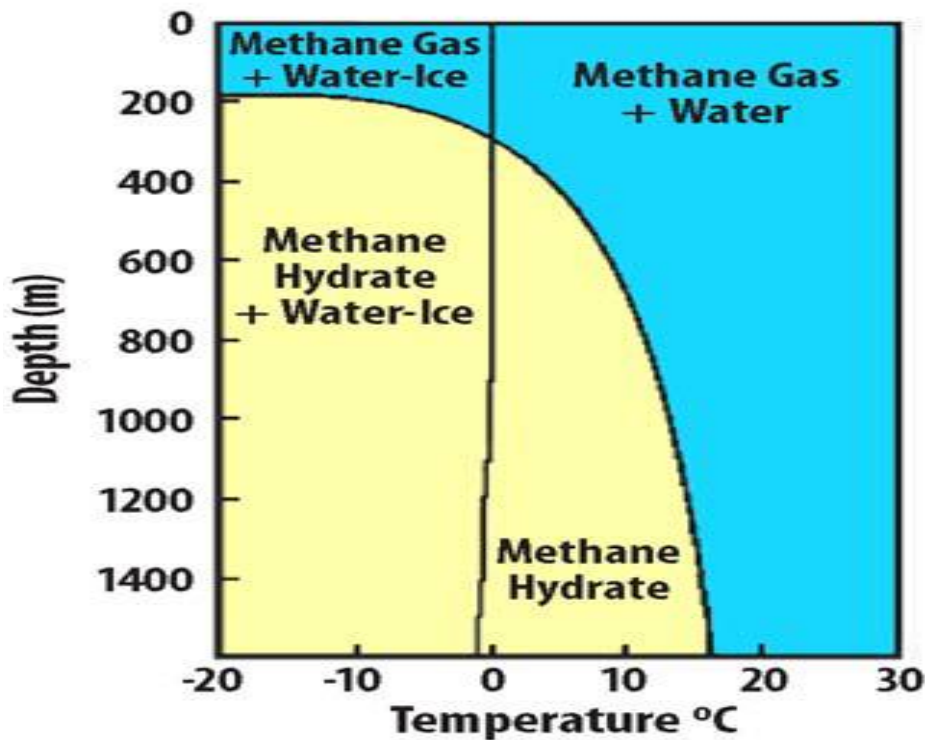

Figure 4.7 Methane Hydrate Stability Graph (Smith 2011)

Other Factors Which Affects the Stability of Methane Hydrates:

Higher salt concentration in water will prevent the formation of methane hydrates. Elevated salinity can shift the hydrate formation temperature to the left side of the graph, low temperature required for the formation of hydrates. In same way, presence of CO₂ and H₂S or some other heavier hydrocarbons like ethane will move the temperature to right side, formation possible at higher temperatures.

When collecting methane hydrate sample from the sediments proper care has to be taken otherwise before reaching the surface of the Earth dissociation will occur and the methane and water will be separated. Therefore, recovery process has to be fast and properly pressurized or refrigerated to keep it in hydrate state.

Methane hydrate is a concentrated form of natural gas. When dissociated at normal surface temperature and pressure, one cubic foot of solid methane hydrate will release about 164 cubic feet of methane gas (Smith 2011). This property attracts the people towards the methane hydrates.

4.1.3 Methane Extraction from Methane Hydrate

For the recovery of methane gas enough technology is present now also the production methods have changed little bit when compared with old methods (**Ruppel 2011**). The dissociation formula will look like,

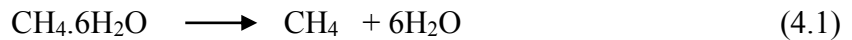

ΔH Enthalpy = 10 ~ 20 Kcal / mol of gas dissociated. This reaction requires an external energy source to propagate along the right hand side (**Alexander 2004**).

There are different methods for extracting methane and all the process involved solve and control the dissociation process. Before starting the extraction process of methane, the environment around the marked places has to be examined clearly and the technique used to extract gas has to be a safe technique, efficient, cheap and safe for the environment (**Mushtaq 2012**).

There are three techniques currently under study to recover gas from methane hydrates (**Alexander 2004**)

- 1) Thermal Injection
- 2) Depressurization
- 3) Inhibitor Injection

4.1.3.1 Thermal Injection

Hot water or steam will be injected into the hydrate formation to raise the temperature and to initiate the dissociation. Then, methane and water molecules get separated and the methane will get sucked by the pipeline to the surface. This process has a very good energy balance level. This method is very simple and doesn't have lot of complicated systems and devices. The major disadvantage is heating and sending the fluids to the hydrate sediments. This heating has to be supplied continuously to continue the dissociation process and to stop the formation of new hydrates (**Mushtaq 2012**).

There are following four simple steps which are involved in methane hydrate dissociation process by hot water injection,

1. Displacement of free methane gas due to water injection
2. Additional methane hydrate formation at downstream zone because of migration of dissociated gas and water

- 3. Actual methane hydrate dissociation
- 4. Completion of dissociation

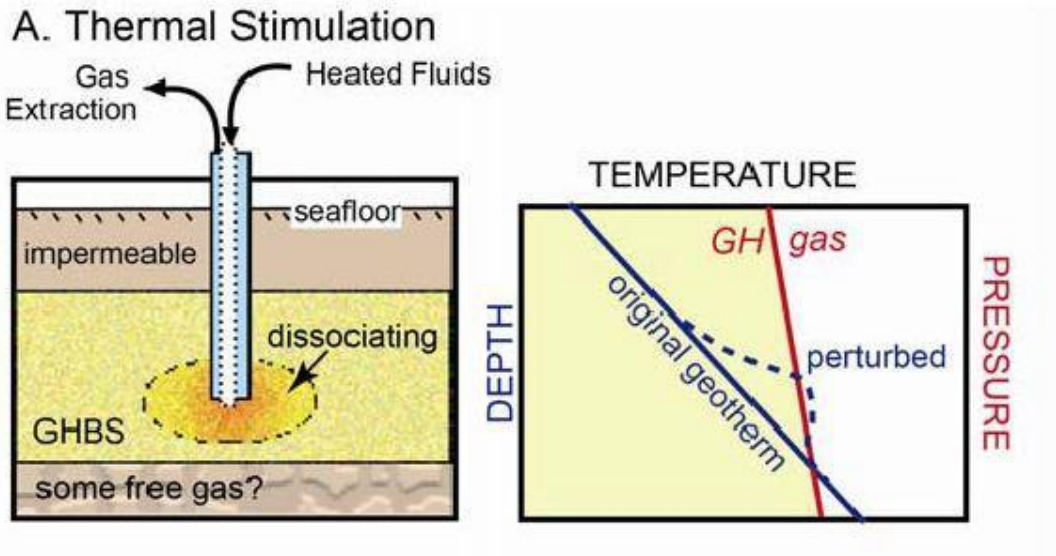

Figure 4.8 Methane Recoveries by Thermal Stimulation (Ruppel 2011)

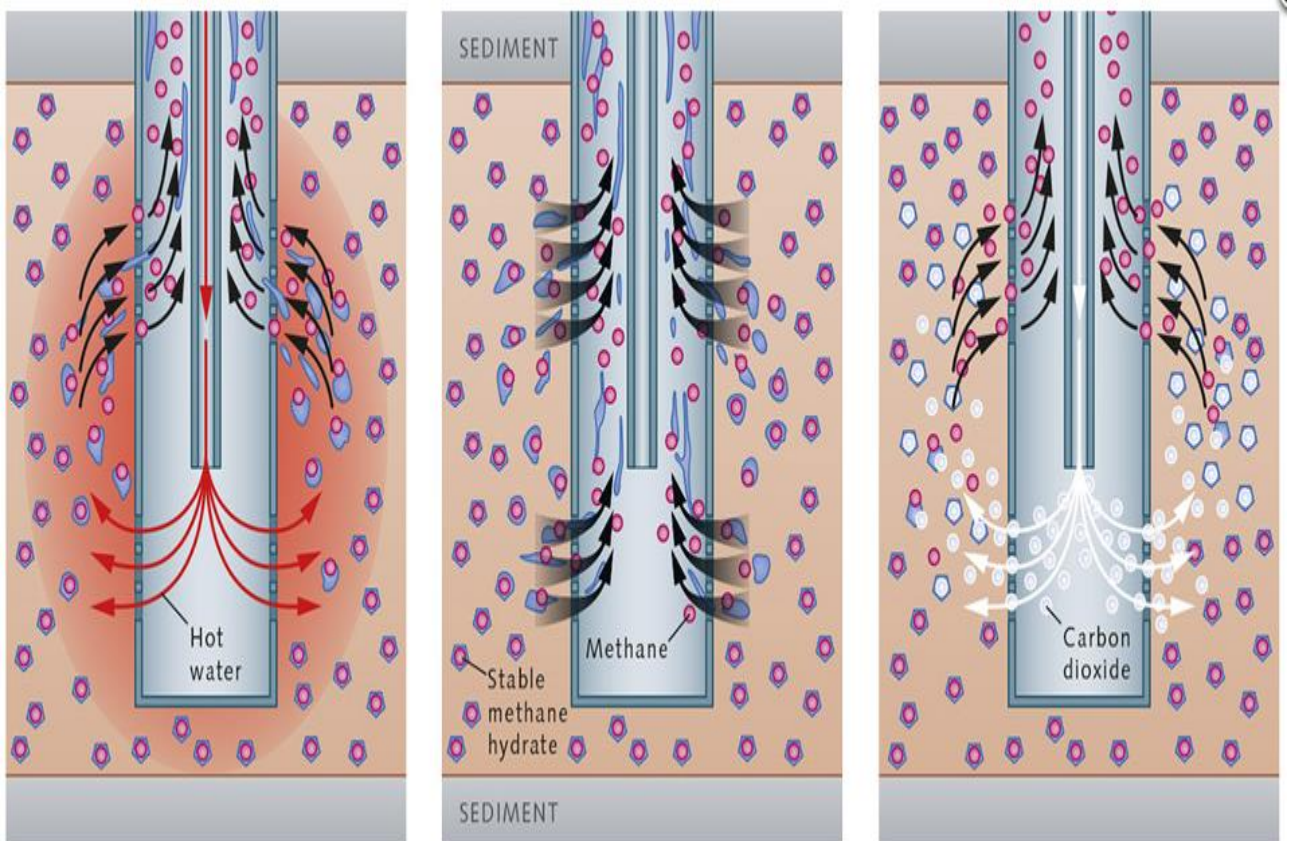

Figure 4.9 Methane Production Processes -1) Hot Water Injection, 2) Depressurization 3) Carbon Dioxide Injection (World Oceanic Review 2014)

4.1.3.2 Depressurization

In this method hydrates in sediment beds are exposed to low pressure environment, this make hydrates to dissociate. For this, hole is drilled from surface to the hydrate bed and this make the path for the methane to reach the surface without involving again in hydrate formation. Thermal energy for this process comes from Earth interior. Depressurization is the easiest way among the other methods because it's a self-driving method. Nevertheless, more tests and experiments have to be done before implementing this method (**Mushtaq 2012**).

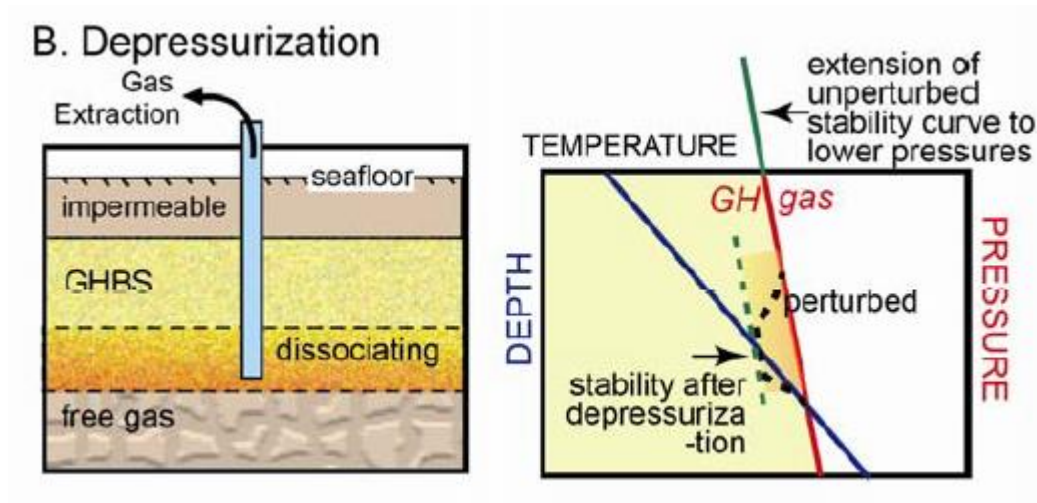

Figure 4.10 Depressurization Process (**Ruppel 2011**)

This process is carried out under following assumptions:

1. Hydrate dissociation occurs as soon as the reservoir pressure drops below the dissociation pressure for the hydrate at the reservoir pressure
2. The gas flows immediately to the free-gas zone
3. Rock and water expansion during gas production are negligible
4. The model neglects heat transfer between reservoir and surroundings
5. The reservoir is produced from a single well located at the center

This method does not need lot of energy and up to certain time, dissociation time is fast. When compared with other methods no energy loss, no need for additional equipments and simple, suitable for large-scale production.

4.1.3.3. Inhibitor Injection

Most of the off shore applications this method is followed. At a given pressure inhibition injection is carried out, this reduces the temperature for hydrates forming. In general use inhibitors alcohols, methanol, glycols, seawater or brine will act as inhibitors. Alcohols and glycols showed better performance and it can be used as an inhibitors. Salts also provide same results but it has some corrosion problems (Alexander 2004). The advantage of this method is that the dissociation rate can be controlled by adjusting the inhibitor supply. In addition, this prevents the clogging in pipelines (Mushtaq 2012).

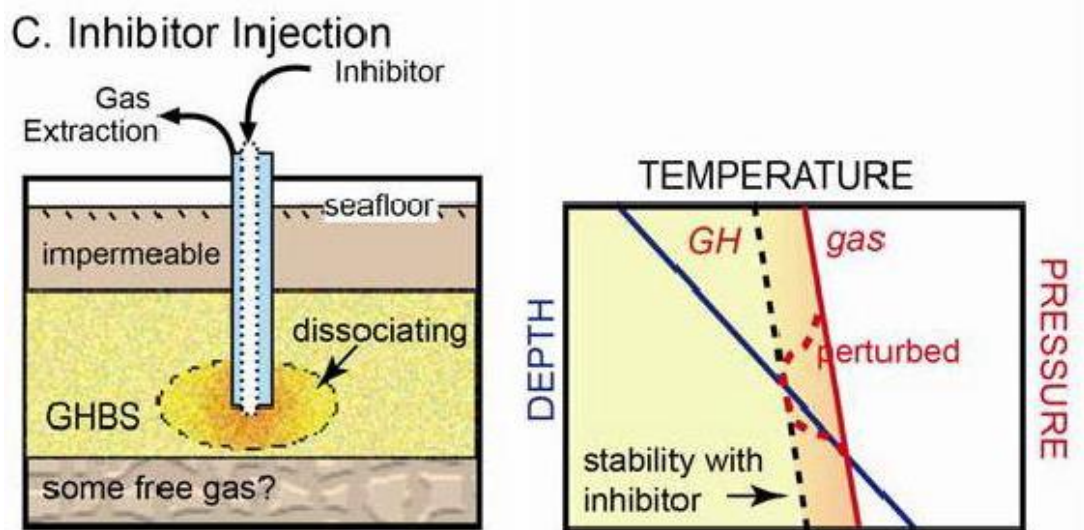

Figure 4.11 Inhibitor Injection Process (Ruppel 2011)

CO₂ used as an inhibitor. Figure 4.11 shows the CO₂ inhibitor injection process. This will reduce the carbon dioxide level in atmosphere because this carbon dioxide will be trapped in methane hydrate place.

Then the methane is transferred to the FT reactor plant. There it is used to make the Synthetic Jet fuel.

4.1.4 ATR Reaction Mechanism

This Auto Thermal Reforming (ATR) consists of three main reactions:

1. Steam methane reforming
2. Water gas shift reaction
3. Partial oxidation

Reaction chemical reaction formula with its enthalpy is shown below.

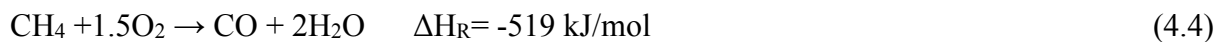
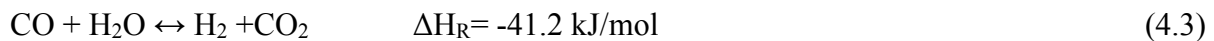
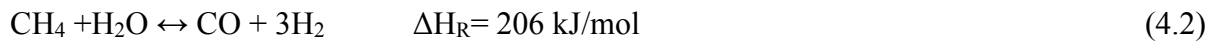

ATR process is most effective process for the conversion of natural gas to the syngas. As we can see the chemical reaction formula only the first reaction need heat to be supplied to the system. Second and third reactions emit heat from the system. Therefore, overall this system is very heat effective system (Kim 2009).

4.1.5 FT Process

The Fisher-Tropsch (FT) process involves the steam reforming or gasification of any carbon containing feedstocks to syngas, which is a mixture of carbon mono oxide and hydrogen. Syngas is converted into hydrocarbon products in presence of a catalyst. A third upgrading step cracks the longer hydrocarbons chains to maximize the production of synthetic paraffinic liquids (jet fuel). FT process converts the syngas into synthetic fuel. SBCR (slurry bubble column reactor) used for the Fisher-Tropsch Synthesis (FTS) is shown in Figure 4.12. The main reactants are carbon monoxide and the hydrogen. The main FT reaction equation is,

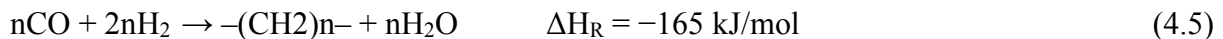

There are other possible reactions taking places in the FT reactor. These reactions are listed in the Table 4.1. Heat emitted from the process has to be controlled otherwise; it will affect the overall process. In addition, it reduces the FT reactor efficiency. Generally, with use of water this heat is reduced. Steam from the water used to produce electricity or the heat is directly used for some other processes based on the reactor setup.

Table 4.1 Possible Reactions in the FTS (Kim 2009)

Reaction	$\Delta H_{300K}(\text{kJ/mol})$
$\text{CO} + 2\text{H}_2 \rightarrow -\text{CH}_2 - + \text{H}_2\text{O}$	-165
$2\text{CO} + \text{H}_2 \rightarrow -\text{CH}_2 - + \text{CO}_2$	-204.7
$\text{CO} + \text{H}_2\text{O} \rightarrow \text{H}_2 + \text{CO}_2$	-39.8
$3\text{CO} + \text{H}_2 \rightarrow -\text{CH}_2 - + 2\text{CO}_2$	-244.5
$\text{CO}_2 + 3\text{H}_2 \rightarrow -\text{CH}_2 - + 2\text{H}_2\text{O}$	-125.2

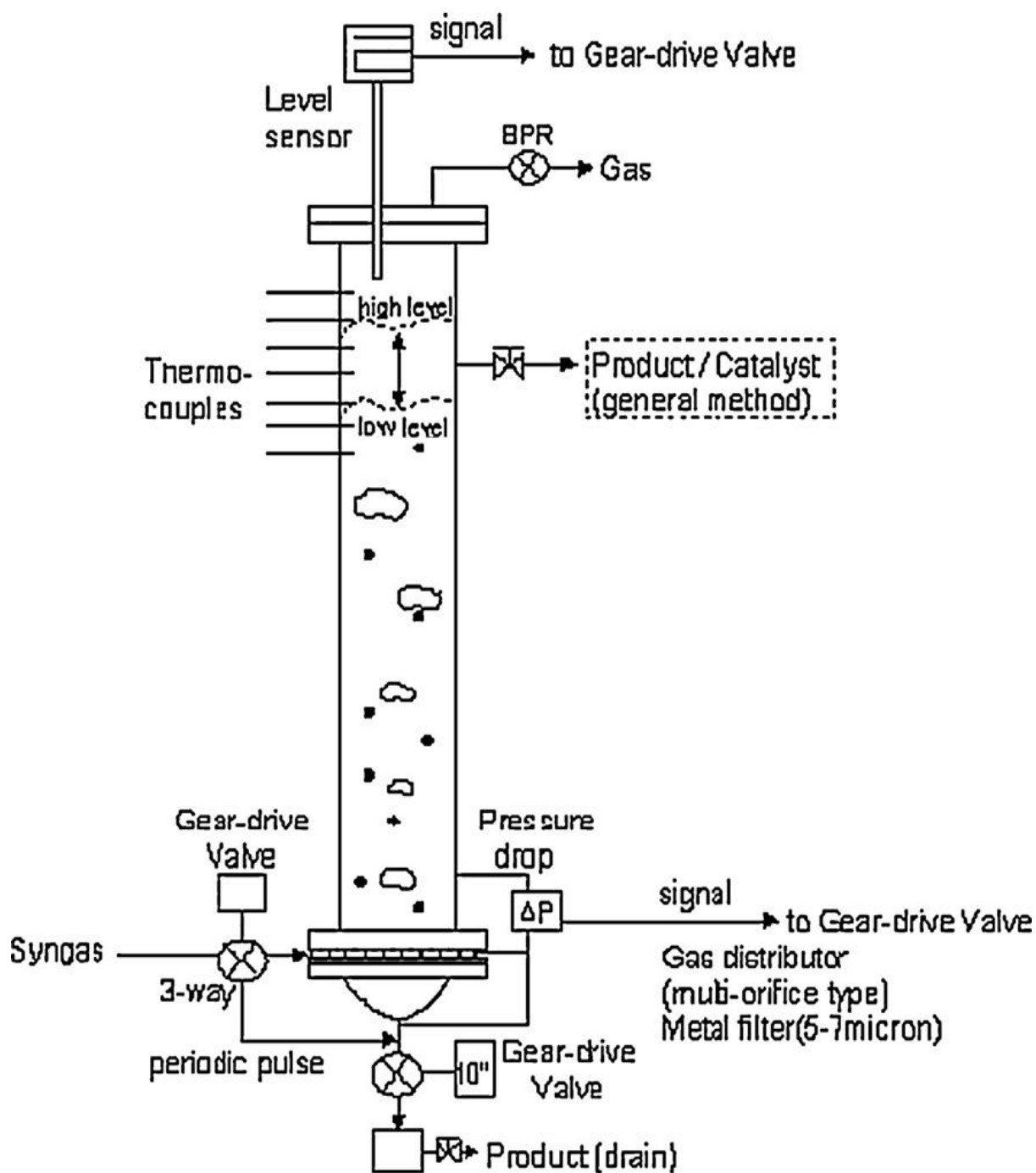

Figure 4.12 FTS Reaction in SBCR (Kim 2009)

4.2 Biomass to Liquid

The process of Biomass to Liquid (BTL) has not yet been developed to industrial production level. However, the process is successfully proven in laboratory level. Whole process can be divided into two. Biomass gasifier to produce syngas from the biomass and FTS to produce synthetic fuel from the syngas supplied. Overall design of the system together with the biomass gasifier and FTS reactor has to produce high amount of liquid hydrocarbons with low energy consumption. In the gasifier, precaution has to be taken to prevent the formation of the methane. All the carbon present in the biomass has to be converted into carbon monoxide. Methane formed in the gasifier is separated and it is not going to participate in the FT reaction and it reduces the overall efficiency of the reactor. When atmospheric gasification process used it prevents the formation of methane but later produced synthetic gas has to be pressurized, pressurized gasification saves the compression cost. Product comes out of the gasifier has to be cleaned properly before it's fed into the FT reactor. The gas usually contains tar, hydrogen sulphide, carbonyl sulphide, ammonia, hydrogen cyanide, and alkali and dust particles.

In between gasifier and FT reactor there are set of additional equipments present to perform their specified work. Ratio of the hydrogen and carbon monoxide has to be maintained from 0.8 to 1.6. Normally, FT reactor consumes hydrogen twice compared to the same amount of carbon monoxide. To manage this shortage of hydrogen steam reforming of methane or solar driven water electrolysis process is used. WGS (Water gas shift) reactor is used to maintain the ratio between carbon monoxide and hydrogen.

Effective use of heat sources is one of the main costs saving process. There is huge amount of reaction heat is released from the FT reactor. This heat can be used to dry the wet biomass (Prins 2005).

Overall Process Description

Figure 4.13 shows the overall process description as a block diagram. Heat removal or transfer is shown with the dotted line. Biomass is dried to 10% moisture with the help of heat removed from FT reactor in indirect method. Gasification process takes place at atmospheric pressure and 900⁰ C temperatures. The gas coming out from the gasifier is then cooled down to 90⁰ C, and creating 50 bar pressure and 20 bar steam. This pressure steam is used to produce electricity. In the cleaning process, ash particles are separated by filtration method. In addition, acid gases, ammonia and salts are removed by washing with water. Composition of the feed gas for the FT reactor 26% hydrogen, 44% nitrogen, 17 % carbon dioxide, 12 % carbon monoxide and small amount of methane (dry). Gas is converted to liquid

hydrocarbons at a temperature of 260⁰ C by cobalt-catalyzed FTS. The outcome liquid products are naphtha (C5–C8). Diesel (C9–C22) and wax (C23+).

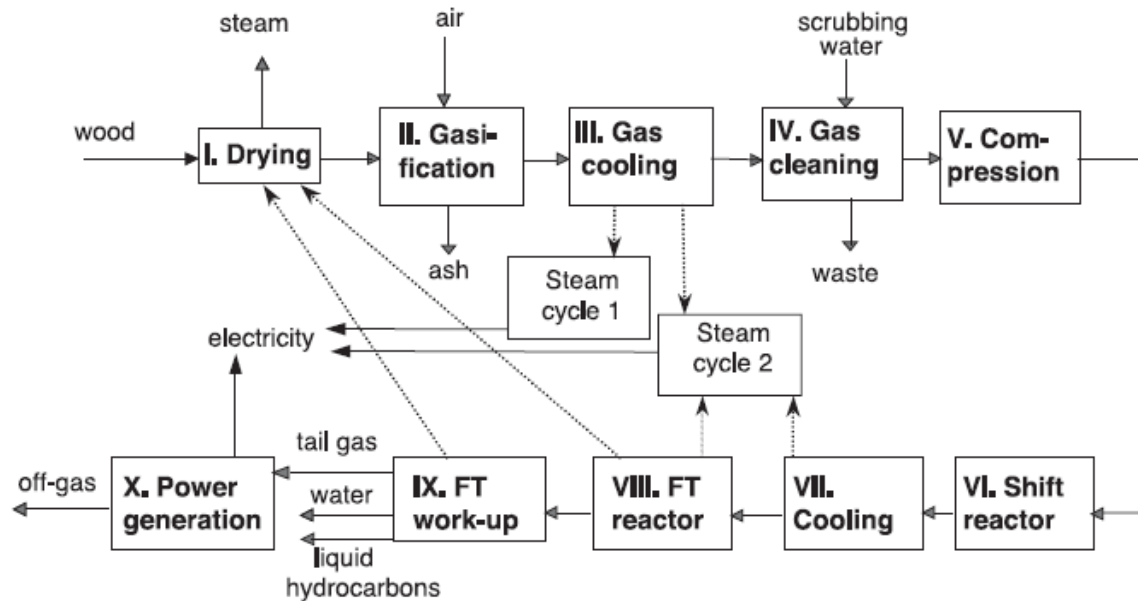

Figure 4.13 Block Diagram of Biomass to Liquid Process (Bellman 2007)

4.3 Coal to Liquid

There are two different methods to convert coal to liquid (CTL) fuel.

1. Direct Liquefaction
2. Indirect Liquefaction

4.3.1 Direct Liquefaction

Direct Liquefaction is same as the hydrocracking process, which is used by petrol refining industries to convert heavy oils into gasoline, jet and diesel fuel.

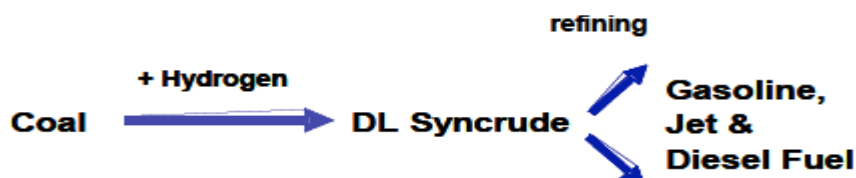

Figure 4.14 Direct liquefaction Process (Bellman 2007)

Direct liquefaction has two reactor stages. The first stage is thermal process where, the coal structure is broken down during this process high hydrogen pressure is required to stabilize the process and to prevent the formation of coal. The second stage is similar to hydrocracking. The product must be further processed to produce liquid fuels. The hydrogen required for this process can be obtained by coal gasification and water gas shift reactor process. It is possible to use the hydrogen produced by means of some other sources. Thermal efficiency of the direct liquefaction process is around 55% (Bellman 2007).

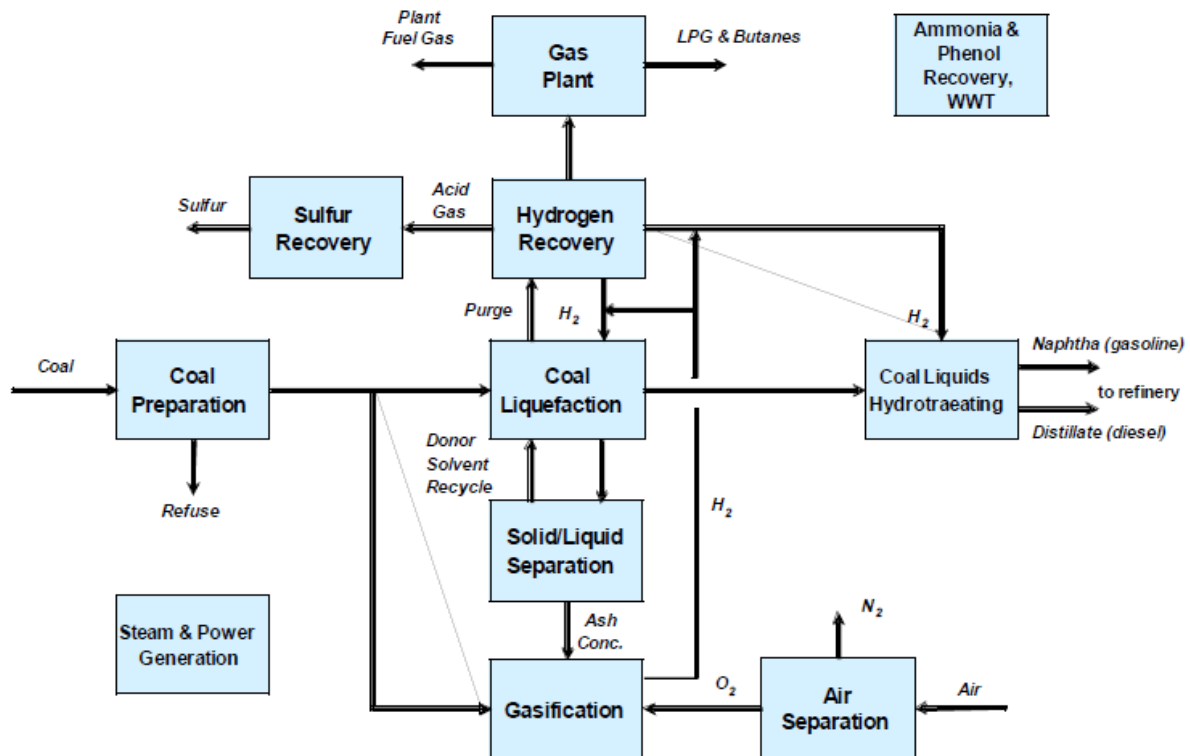

Figure 4.15 Block Diagram for Direct Liquefaction Process (Bellman 2007)

Figure 4.15 shows the overall process block diagram for direct liquefaction process. The main processes in the plant are explained below.

Process Description: First part of section includes coal cleaning, grinding and drying, coal liquefaction, ash removal arrangement, extraction system and hydrogen recycle. The processed coal (cleaning, drying, grinding) is fed into the liquefaction reactor at a temperature of 750-800⁰F and pressure 3200 psig. The products from the reactor are liquid and gaseous hydrocarbons. The products such as gas, naphtha and distillate products are separated with liquid-solid separation unit. Then these liquid hydrocarbons are further processed to produce lighter fuels. Recovered hydrogen is sent back to the liquefaction unit. The solid products are mixed butanes and propane and gaseous products are methane and ethane (Bellman 2007).

4.3.2 Indirect Liquefaction

Indirect liquefaction has many process steps to produce liquid fuels. First, coal has to be converted into gas by partial oxidation process (gasification). Oxygen supplied for this process must have high purity level along with the steam. Syngas is the resultant product of the gasification process. In this mixture along with the syngas, there are different amounts of water, steam, carbon dioxide and impurities from coal. Especially, sulfur and nitrogen mixed compounds and ash has to be removed by gas clean up processes. Figure 4.16 explains process flow diagram of indirect liquefaction process.

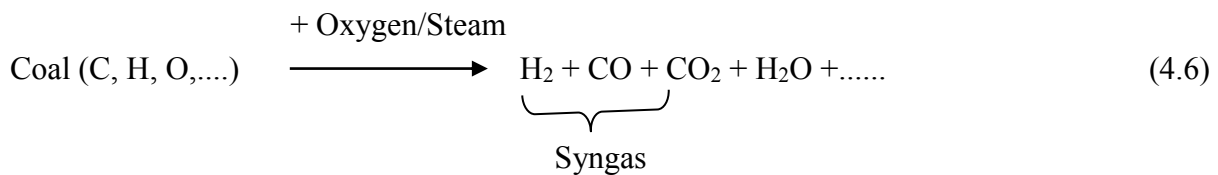

Syngas Production: First, coal has to be prepared by cleaning, drying, grinding. Then coal is fed into the gasification chamber. Air separation unit supplies the oxygen to the gasification chamber. Syngas cleaning process includes hydrolysis, cooling, sour-water stripping, acid gas removal, and sulfur recovery. This cleaning process is done in order to improve the quality of the output fuel. Water used to cool down the syngas. Then, steam produced during cooling process used to produce electricity. Syngas from the coal gasification has very low hydrogen to carbon monoxide ratio of 0.49, which has to be increased to two. This can be done by water gas shift reactor (**Sudiro 2009**). FT process produces hydrocarbons that can be converted into jet fuel.

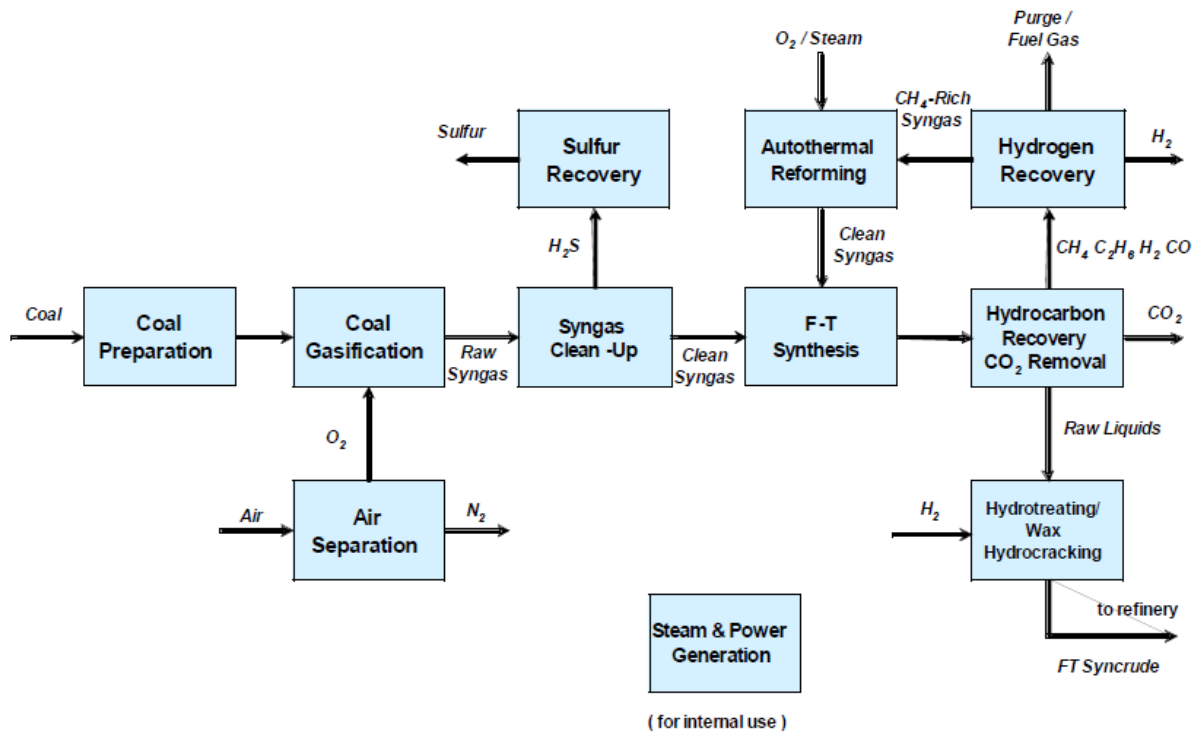

Figure 4.16 Process Flow Block Diagram of Indirect Liquefaction Process (Bellman 2007)

Iron or cobalt based catalysts can be used in the reactors. Iron catalyst adjusts the low hydrogen and carbon monoxide ratio by its water gas shift property. Carbon dioxide produced during this process is normally vented to the atmosphere. Instead of that, it can be stored and used for commercial application or can be stored somewhere safely so that it can be used later. This reduces the green house effects (Bellman 2007).

4.4 Sun to Liquid

In the synthetic fuel production process most of the energy is used to produce the syngas. Sun to liquid (STL) is one of the promising technology to reduce the carbon dioxide emission and to reduce production cost of syngas.

STL process uses the concentrated solar radiation to split the carbon dioxide and water molecules and produces syngas. Carbon dioxide is taken from the atmosphere and water is fed into the reactor. This reduces the emission of CO₂ and absorbs the existing CO₂ in atmosphere as an input source.

4.4.1 Production of Syngas

Solar thermochemical cycles based on two steps metal oxide redox reactions with solar energy used to produce hydrogen and carbon monoxide from water and carbon dioxide. Then, this syngas fed into the FT reactor to produce fuel. Among the various metal oxides nonstoichiometric ceria ($\text{CeO}_{2-\delta}$) shows very good characteristics by ability to rapidly conduct oxygen molecules through its lattice and crystallographic stability over wide range of oxidation levels (**Furler 2014**). This process redox reaction is shown below:

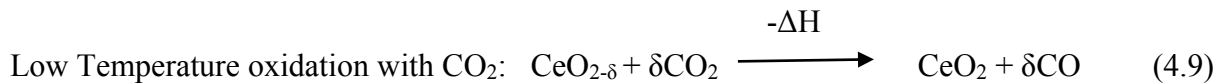
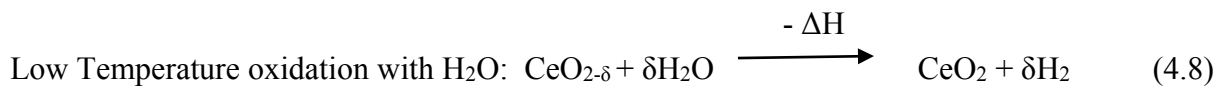
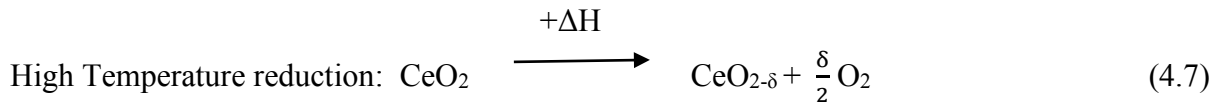

In the equation (4.8) ceria is thermally reduced to nonstoichiometric state using the concentrated solar radiation. In the equations (4.9) and (4.10) ceria is oxidized at low temperature with the water and carbon dioxide and to produce the syngas. When considering the overall reaction ceria remains same, only H_2O & CO_2 changes into H_2 & CO . The remaining O_2 can be used in the following processes.

Figure 4.17 CeO_2 Reticulated Porous Ceramics (RPC) parts fabricated for the solar cavity-receiver. One set consists of a disk (20 mm thickness, 100 mm outer diameter) and four rings (20 mm thickness, 60 mm internal diameter, 100 mm outer diameter) (**Furler 2012**).

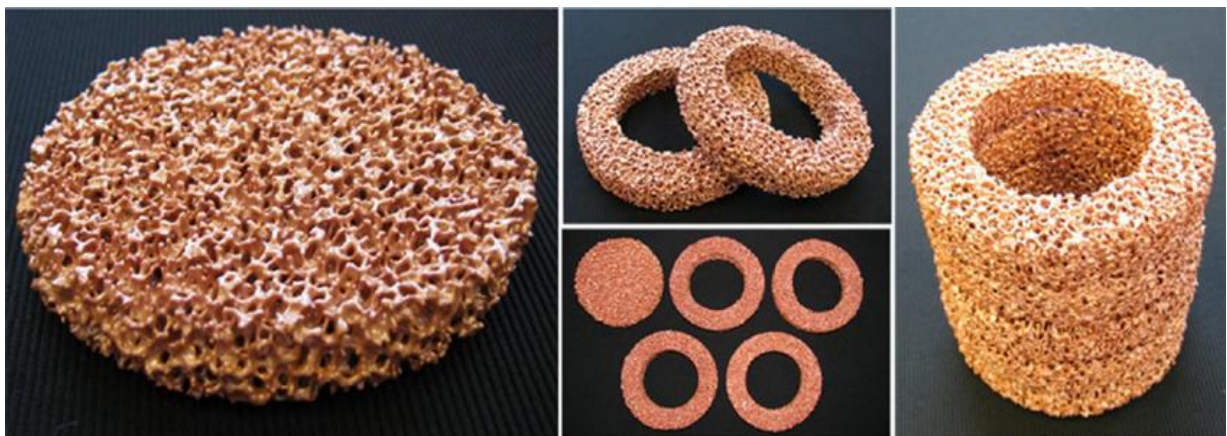

Figure 4.17 CeO_2 Reticulated Porous Ceramic for the Solar Receivers (**Furler 2012**)

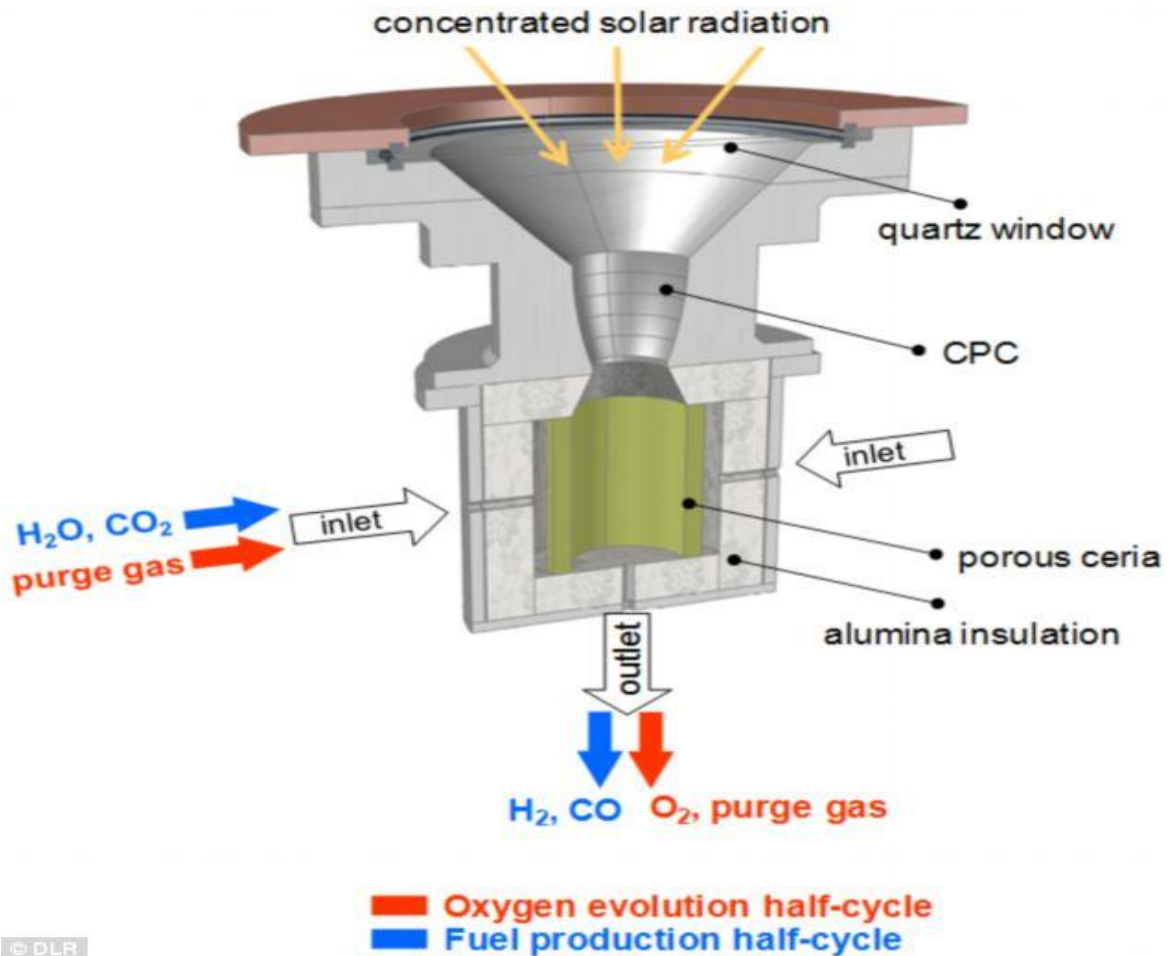

Figure 4.18 Solar Jet Reactor (Luftfahrt 2014)

4.4.2 Solar Reactor Configuration and Setup

Solar (Solar chemical reactor demonstration and Optimization for Long term Availability of Renewable) jet reactor configuration is shown in Figure 4.18. Figure 4.19 and Figure 4.20 shows the laboratory setup of solar jet reactor (DLR 2014). The solar reactor is equipped with a 4 cm diameter aperture for the focused solar radiation. The frontal are is sealed by 24 cm diameter, 3 mm thick clear fused quartz disk window. Followed by the quartz window compound parabolic concentrator (CPC) was equipped in order to increase the solar concentration ratio.

$$\text{Solar concentration ratio (C)} = P_{\text{solar}}/(IA) \quad (4.10)$$

Where, P_{solar} = solar radiative power intercepted by the opening area A,
 I = Solar irradiation

C is expressed in units of suns. When normalized to $I = \text{one kW/m}^2$ it mean values up to 3015 suns. The ceria RPC is the important component in this setup. This ceria RPC one set consists of a single disk (20 mm thickness, 100 mm outer diameter.) and four rings (20 mm thickness, 60 mm internal diameter, 100 mm outer diameter). Total weight of this ceria is 1413 g. This ceria is insulated by Aluminum oxide (Al_2O_3) and an outer shell of Inconel alloy 600. Temperatures are measured at the outer surface of RPC and at the insulation and outer surface of the inconel wall. Argon (purge gas) and carbon dioxide flow rates are controlled by electronic mass flow controller Bronkhorst F-201C. Reactant gases were sent into the reactor through the radial inlet and the resultant gases comes out through the axial outlet port at the rear end of the reactor (**Furler 2012**). From the outlet, gases are separated. Syngas is fed into the FT reactor to produce synthetic fuel, the purge gas is reticulated, and O_2 stored for some other purposes in the downstream.

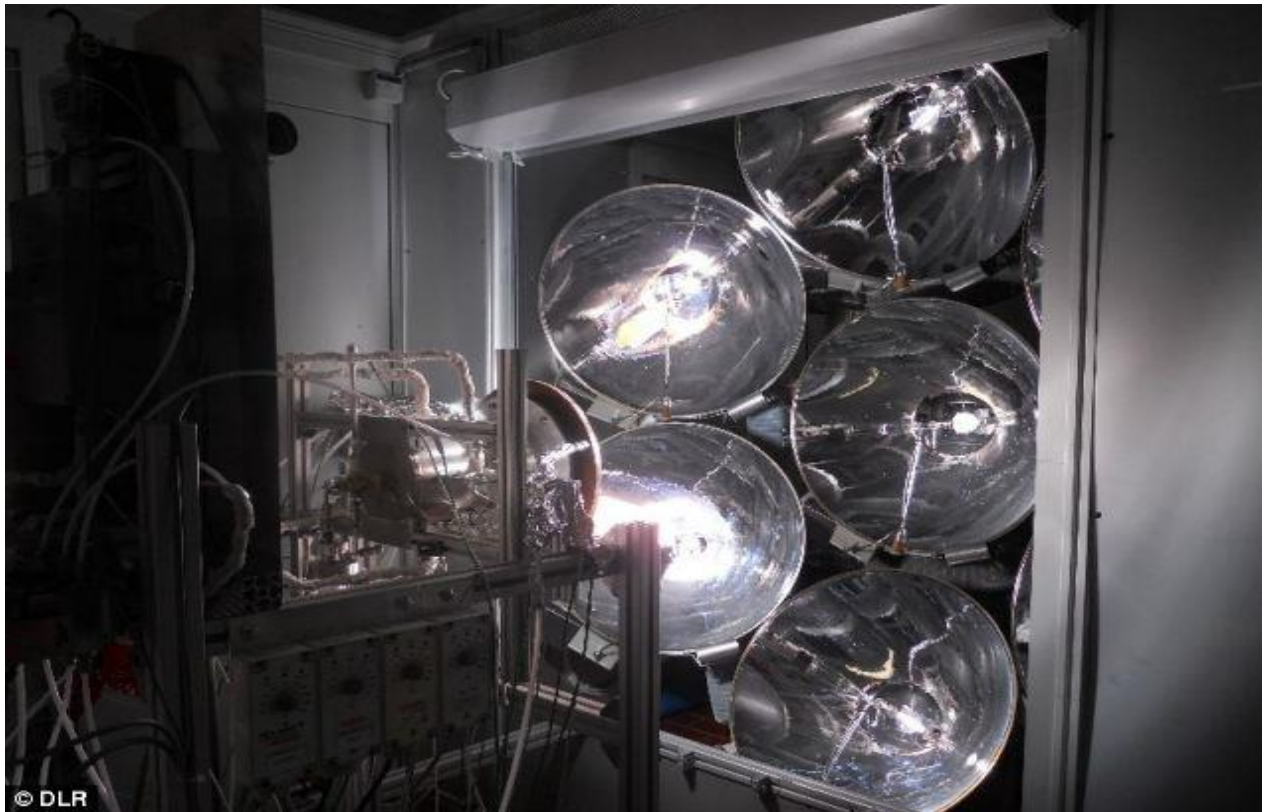

Figure 4.19 Overall Setup of Solar Jet Reactor (DLR 2014)



Figure 4.20 Frontal Area of the Solar Jet Reactor (DLR 2014)

4.5 Power to Liquid and Power to Gas

Power to liquid (PTL) is the process of producing synthetic fuel from H₂O and CO₂. Electrolysis and Solid Oxide Electrolysis Cells (SOEC) used to crack down the water molecules and it produces H₂ and O₂. Then, hydrogen is used to reduce CO₂ in to CO. This H₂ and CO used to produce the synthetic fuel by treating it with the FT reactor.

Power to Gas (PTG) is the process of producing methane from H₂O and CO₂. Electrolysis and Solid Oxide Electrolysis Cells (SOEC) used to crack down the water molecules and it produces H₂ and O₂. Then, hydrogen reacts with CO₂ to produce methane gas (CH₄) (**Varone 2015**).

PTL and PTG Technologies:

The main processes include in fuel production are,

1. Carbon source
2. Hydrogen and Syngas production
3. Fuel synthesis

4.5.1 Carbon Source

The carbon dioxide could be from any recycled sources. CO₂ can be captured from companies, which burns coal or fossil fuel in large quantities. Technologies are developed to capture CO₂ from atmosphere. Carbon capture technology from atmosphere avoids the transportation and storage problems of carbon dioxide. Also carbon dioxide produced during the fuel production cycle can be used effectively (**Varone 2015**).

4.5.2 Electrolysis and SOECs (Hydrogen)

Electric energy can be converted in to chemical energy with the use of electrolysis cell. Efficiency of this cell is very high because of the absence of the moving parts. Recent finding of Solid Oxide Electrolysis Cells (SOEC) is well suited for this purpose. High temperature inside the cells can electrochemically reduce the H₂O or H₂O and CO₂ at very high efficiency in to H₂ or Syngas. Later on, this syngas can be used for synthetic fuel production. SOEC operates at a range of 700 to 1000 °C. Heat required for the chemical reaction is obtained from the electrolysis cell itself. Achievable process efficiency is up to 70%.

4.5.3 Fuel Synthesis

Syngas produced from the SOEC is fed into the FT reactor and the required fuel is produced. Synthetic fuel production process is well explained in the chapter 4.1.

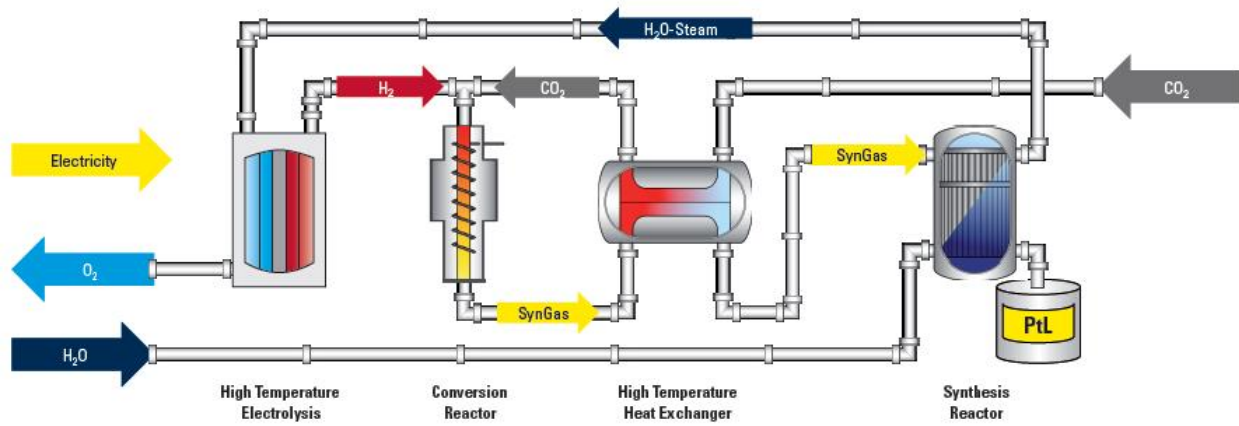

Figure 4.21 Overall Process description of PTL process (SunFire 2015)

5 Certification and Regulations for Alternative Fuels

The commercial aircraft operation and design is regulated by the national agencies or organization, for example Federal Aviation Administration (FAA) in USA and European Aviation Safety Agencies (EASA) in Europe. The aviation fuel going to be used for this aircrafts must meet the requirements of the aircraft manufactures and engine performance properties. So, these fuels must be approved by the agencies for the individual countries also by the International organizations. Aviation fuel industries have collaboration with these agencies to get certified and qualified to get the drop in jet fuel status. Certification and qualification processes are done by ASTM International aviation fuel subcommittee (subcommittee J). This subcommittee J coordinates the evaluation of data and the establishment of specification criteria for the new alternative fuels.

This subcommittee J has made two standards for this process,

ASTM D4054- Standard practice for Qualification and Approval of new Aviation Turbine Fuels and Additives

ASTM D7566- Standard Specification for Aviation Turbine Fuel Containing Synthesized Hydrocarbons (**IATA 2013**)

5.1 ASTM Approval Process for Alternative Fuel

ASTM D7566 was released in September 2009. This specification explains fuels that have composition and performance properties similar to Jet A/A1 fuel can be considered as "drop in" fuel. The specification is structured with Annexes, that defines the compositional and requirements for the alternative fuels that can be mixed with the jet fuel at regulated volumes in order to get the drop in fuel status. There are two annexes for the approved drop in fuels; these can be blended up to 50 % volume with JET A/A1 fuels.

1. Fischer Tropsch (FT)
2. Hydroprocessed Esters and Fatty Acids (HEFA)

ASTM D1655 International Standard Specification for Aviation Turbine fuels defines the requirements for petroleum derived jet fuel. This identification provision allows the drop in fuels listed in D7566 can be used in airports infrastructure and on to the aircraft without any special approval. All the infrastructures are already designed for the ASTM D1655 jet fuel. Once the alternative jet fuel is added in D7566 annex, this fuel meets the requirements and

operating limitations for the existing approved ASTM D1655 jet fuel. Fuels that are not coming under the operation limitations must undergo separate regulatory approval process following ASTM qualification process. Figure 5.1 explains the process of certification for alternative jet fuel (IATA 2013).

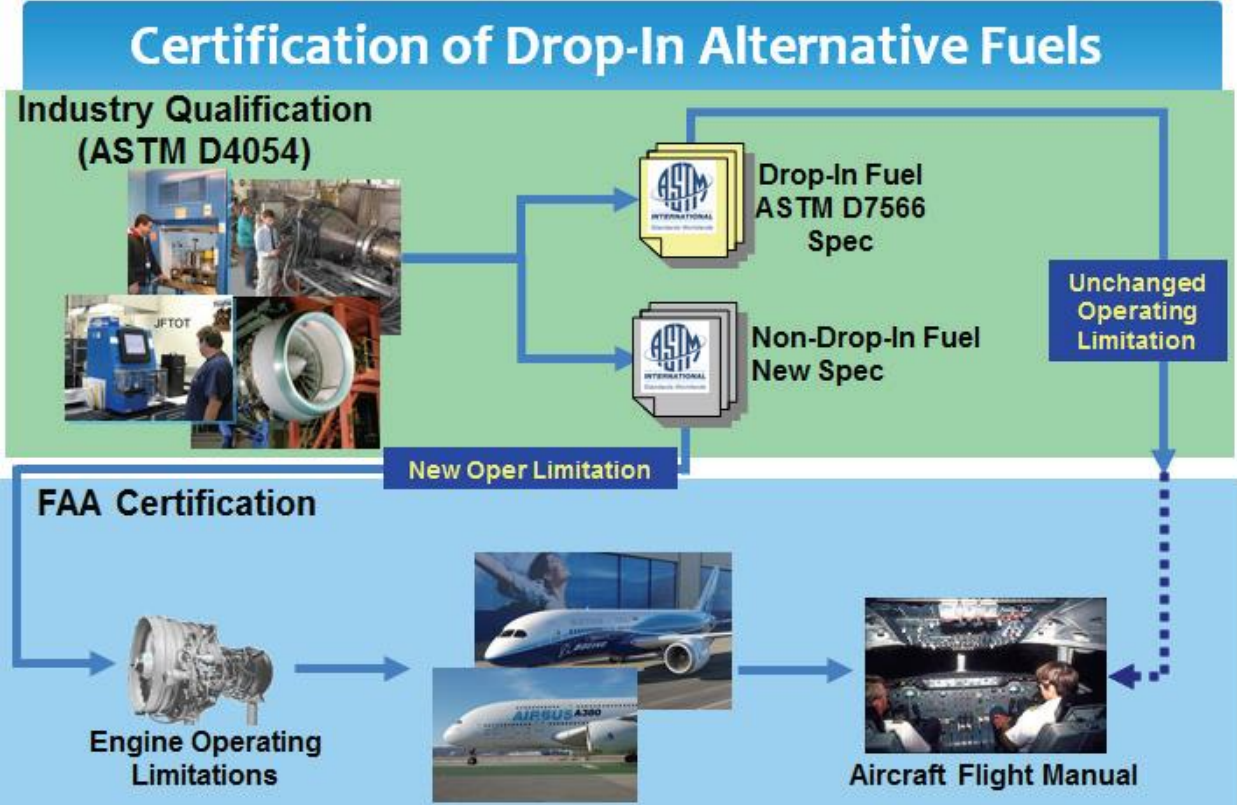

Figure 5.1 Certification Process for Alternative Jet Fuels (IATA 2013)

ASTM D4054 was created to give guidelines to the alternative fuel producers regarding testing and property necessary for the alternative jet fuel. D4054 is a repeated process, until the requirements matches with the ASTM D7566 the processes like testing, composition level and performance carried out again and again. Figure 5.2 shows the certification process of jet fuel (Rye 2010). The D4054 data is used to prove the alternative jet fuel is ready to blend with the jet fuel and to be used in the turbines. In addition, D4054 data must also verify the properties of the alternative fuel must remains same during the production of large-scale industrial process. This data reviewed by ASTM and it is taken to form the new annex for the alternative jet fuel (IATA 2013).

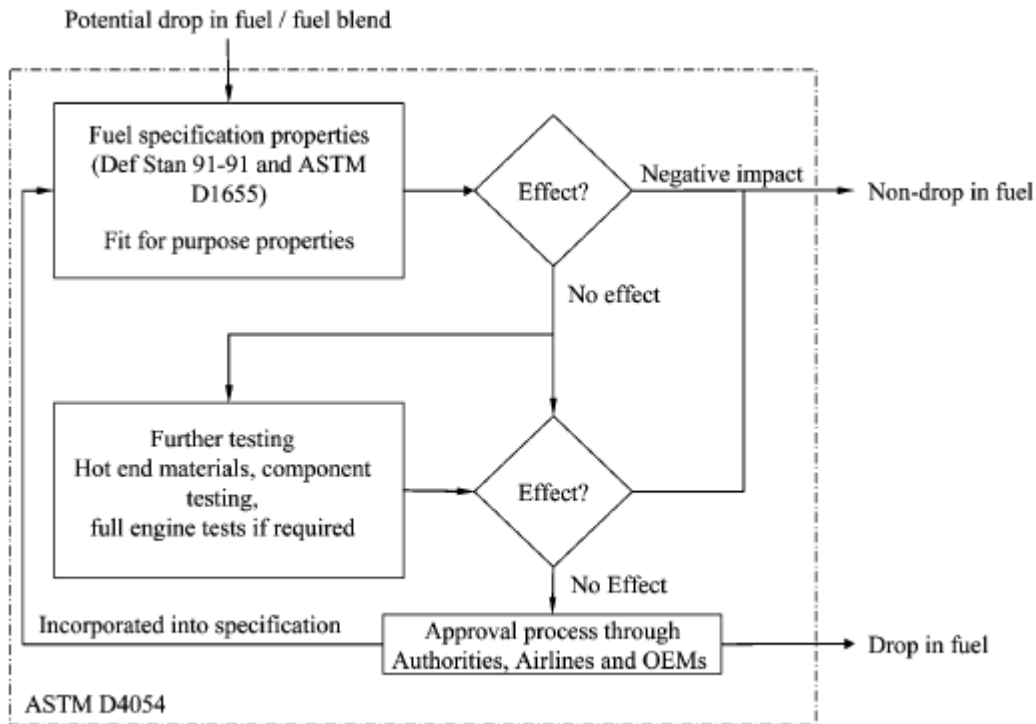

Figure 5.2 Gas Turbine Fuel Approval Process (Rye 2010)

5.2 Gas Turbine Fuel Test Methods

The test methods shown below have both ASTM and Institute of Petroleum (IP) standards. Many test methods are almost same in both ASTM and IP regulations. Any method can be followed to test the fuel specification. However, testing requirements has to be carefully varied before choosing anyone method. Both these test method have ISO equivalent standards (Greg 2006).

Table 5.1 Common Test Methods Used for Jet Fuel Specification Testing (Greg 2006)

Property	Standard Test Method	Description
Distillation	ASTM D 2887 / IP 406 – Boiling Range Distribution of Petroleum Fractions by Gas Chromatography	A small portion of sample is injected onto a non-polar GC column, which separates compounds by boiling point. The elution time is converted to a boiling point by analyzing a mixture of n-paraffin of known boiling points under identical conditions.
Thermal Stability	ASTM D 3241 / IP 323 – Thermal Oxidation Stability of Aviation Turbine Fuels (JFTOT Procedure)	Fuel is pumped over a heated aluminum alloy tube at a constant flow rate for 2.5 hours. After passing through the tube, the fuel is filtered to collect any solid decomposition products. The pressure drop across the filter is measured during the test. After the test, the tube is removed and visually inspected for color changes or stains. Then this is compared with the standard fuel color scale. Main results from this test are visual inspection results and pressure drop across the filter.
Density	ASTM D 4052 / IP 365 – Density and Relative Density of Liquids by Digital Density Meter	A small volume of a sample is introduced into an oscillating tube held at constant temperature. The change in oscillation frequency caused by the change in the mass of the tube is related to the density of the sample.
Viscosity	ASTM D 445 / IP 71 – Kinematic Viscosity of Transparent and Opaque Liquids	A sample is placed in a calibrated glass viscometer and held at a closely controlled temperature. The time required for a specific volume of the sample to flow through the capillary under gravity is measured. This time is proportional to the kinematic viscosity of the sample.
Freezing Point	ASTM D 2386 / IP 16 – Freezing Point of Aviation Fuels Referee Method	A sample is placed in a special jacketed tube fitted with a stirring rod and a thermometer. The tube is placed in a low-temperature bath and stirred as the sample cools. When crystals of hydrocarbon appear, the tube is removed from the cooling bath and allowed to warm up slowly with continuous stirring. The temperature at which the hydrocarbon crystals completely disappear is the freezing point.

Sulfur	ASTM D 1266 / IP 107 – Sulfur in Petroleum Products (Lamp Method)	A sample is burned in a glass lamp with a cotton wick to oxidize the sulfur-to-sulfur dioxide. The combustion gases are bubbled through a solution of hydrogen peroxide to convert the sulfur dioxide to sulfuric acid. The amount of sulfuric acid formed is measured by either barium precipitation or titration.
Smoke Point	ASTM D 1322 / IP 57 – Smoke Point of Kerosene and Aviation Turbine Fuel	The sample is burned in a wick-fed lamp. The smoke point is the maximum height of flame that can be achieved without smoking.

In addition to the above-mentioned tests there are several other tests like Vapor Pressure test, Flash point test, Acidity test, Aromatics content test, Smoke point test, water content test, Electrical conductivity and Lubricity test. All tests are carried out with the ASTM standard **(Greg 2006)**.

5.3 Test Results and Comparison for Synthetic Jet Fuel Blends

This part compares the properties and characteristics of the Synthetic Paraffinic Kerosene (SPK), which is derived from the coal or natural gas and blends with the petroleum derived Jet A/A-1/JP-8. The results from this comparison used to define the acceptable range of compositions of SPK derived from synthetic gas that can be blended with the conventional Jet fuel.

The five SPK fuels are identified for the comparison. In this, first fuel was produced from coal and other four fuels are from the natural gas.

1. Sasol IPK: This fuel is derived from coal. Producer Sasol use this fuel to blend with semi synthetic jet fuel. This fuel is approved by DEF STAN 91-91. It has been in regular supply in Tambo International Airport (South Africa) since July 1999.
2. S-8: This synthetic fuel is derived from natural gas. The Syntroleum Corporation made this fuel for the use of US Air Force. This fuel met all the specifications just as the JP-8. Due to concern over the aromatics, it was used in 50/50 blend with the JP-8 during the test flights of Boeing B-52. Boeing B-52 is certified to fly on semi synthetic jet fuel.
3. Shell GTL: This fuel was produced by Shell Corporation from the natural gas. It is produced in Gas to Liquid (GTL) plant in Malaysia. This fuel was blended with JP-8 in 50/50 ratio to certify more aircrafts for the use of synthetic fuel blends.
4. Sasol GTL-1: This fuel was made by distillation from the GTL fuel produced by Sasol at Qatar. These fuels have freezing point limitations.
5. Sasol GTL-2: This fuel was made by isomerizing the Sasol GTL-1 to reduce the fraction of normal paraffin's. This enable wider range of boiling point but still it has the freezing point problems (**Moses 2008**).

5.4 Comparison of SPKs

The Comparison of properties and characteristics are done in two parts for the five SPK fuels. First basic properties of the SPKs considered identifying the similarities and differences between them. In Second comparison this SPKs are blended in 50/50 ratio with their appropriate petroleum derived jet fuels (JP-8 for S-8 and Shell GTL, Jet A/Jet A1 for Sasol fuels) (**Moses 2008**).

5.4.1 Comparison of Synthetic Paraffinic Kerosene (SPK)

Boiling Point Distribution: Figure 5.3 compares the D86 boiling point distribution (BPD) of the five SPK fuels. For comparison, fuels with highest and lowest BPD from the CRC World Fuel Survey are provided (Moses 2008).

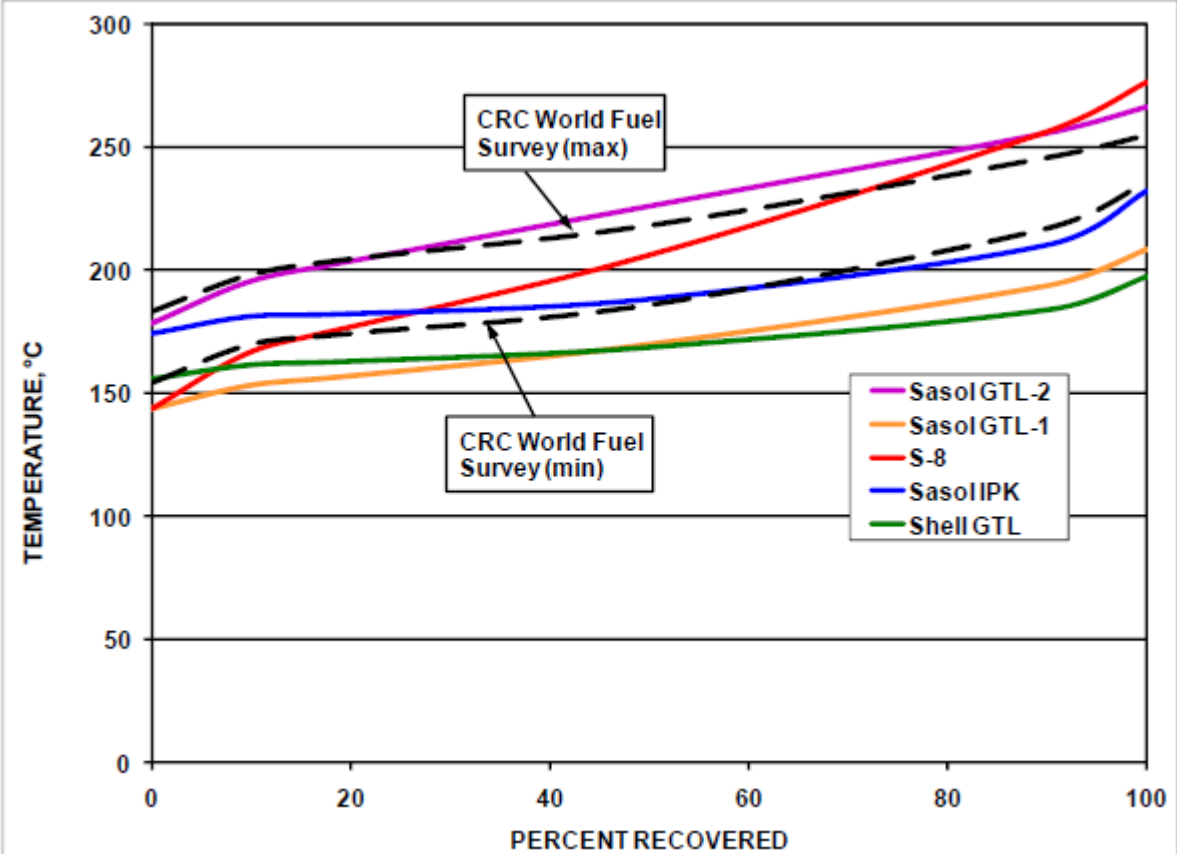

Figure 5.3 Boiling Point Distribution of SPK Fuels (Moses 2008)

Table 5.2 shows the data comparing the slopes of the boiling point distributions with the highest and flattest slopes from the CRC World Fuel Survey (Moses 2008). When going through the distribution S-8 and Sasol GTL-2 fuels have slopes with the reference fuel and other three are relatively flat with the reference fuel distribution.

Table 5.2 Slopes of the Boiling Point Curves for the SPK Fuels (**Moses 2008**)

SPK Fuel	T ₅₀ -T ₁₀ °C	T ₉₀ -T ₁₀ °C
Sasol IPK	7	29
S-8	39	89
Shell- GTL	7	22
Sasol GTL-1	17	40
Sasol GTL-2	30	60
CRC W Survey	14 to 42	55 to 85

Thermal Stability: SPK fuels have very high thermal stability. All the fuels had JFTOT breakpoints over 340 °C. This is due to the lack of metals and impurities in the SPK fuel.

Table 5.3 Thermal Stability of SPK (**Moses 2008**)

SPK Fuel	JFTOT Break Point , °C
Sasol IPK	>340*
S-8	370
Shell GTL	370
Sasol GTL-1	>340*
Sasol GTL-2	>340*

* Testing stopped at the temperature mentioned due to the testing tube temperature limitations.

Density

There are few properties in SPK fuels lower than the conventional fuel. SPK fuel has low lubricity, low electrical conductivity, low density, and lack of aromatics. Low lubricity and electrical conductivity is due to the absence of organics acids in the SPK fuels. Low density, because of the lack of aroma and cyclo-Paraffin's in SPK. Table 5.4 shows the densities of the SPK fuel. It is clear that all five fuels have densities below than the minimum value of 775 Kg/m³. This low density of the SPK will create problem in the blending ration. These blend ratios depend on the density of the petroleum fraction (**Moses 2008**).

Freezing Point

Table 5.4 shows the freezing temperature point of the SPK fuels. All the fuels have lower values than the specification limit. This directly depends on the paraffin's in the SPK and carbon number distribution.

Table 5.4 Density and Freezing Point of SPK Fuels (Moses 2008)

SPK Fuel	Density @ 15 °C Kg/m ³	Freezing Point °C
Specification	775.0 (min)	-40/-47/-47* (max)
Sasol IPK	768.8	<-65 (D2386)
S-8	755	-51(D5972)
Shell GTL	736.1	-54(D5972)
Sasol GTL-1	733.3	-49(D2386)
Sasol GTL-2	761.6	-60(D2386)

5.4.2 Comparison of 50/50 Blend Ratio of SPK with Jet Fuel

Each SPK fuel is blended with the conventional fuel in a 50/50 ratio. Based on the properties and certifying requirements of SPK fuel, conventional fuel chosen to blend with it,

1. Sasol IPK/Jet A-1
2. S-8/JP-8
3. Shell GTL/JP-8
4. Sasol GTL-1/Jet A
5. Sasol GTL-2/Jet A

Boiling Point Distribution

Figure 5.4 represent the boiling point distribution of the five SPK fuel 50/50 blends and Table 5.5 represent the corresponding bending point curve slopes value. Boiling point distribution of the SPK blends are under the specification of the CRC world fuel survey values. However, in the slope curves corresponding values of $T_{90}-T_{10}$ for the Sasol IPK and Shell GTL blends are out of the given values from CRC World Fuel Survey. However, these Sasol IPK and Shell GTL fuels are tested in Aircrafts without any notifying issues (**Moses 2008**).

Table 5.5 Bending Point Curve Slopes for the 50/50 Blend Fuels (**Moses 2008**)

Fuel	$T_{50} - T_{10}$ °C	$T_{90} - T_{10}$ °C
Sasol IPK/Jet A-1	14 °C	46 °C
S-8/JP-8	36 °C	83 °C
Shell GTL/JP-8	17 °C	35 °C
Sasol GTL-1/Jet A	22 °C	68 °C
Sasol GTL-2/Jet A	32 °C	70 °C
CRC World Survey	14 to 42°C	55 to 85°C

T_o = Initial Boiling Point in K; T_i = Temperature at which i percent is distilled in K

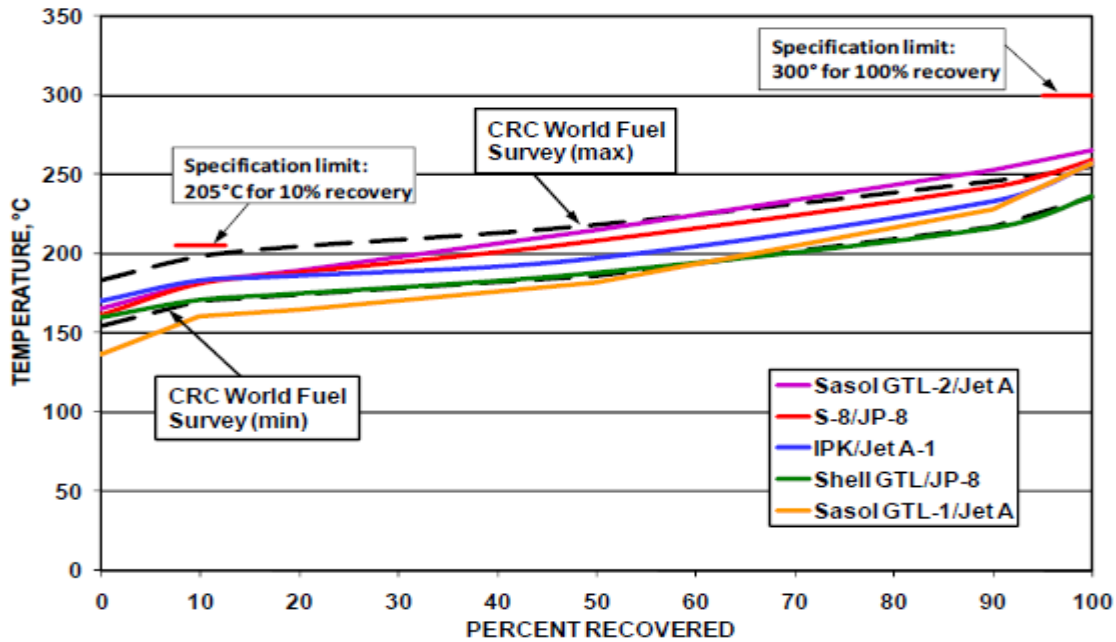

Figure 5.4 Boiling Point Distribution for 50/50 Blend Fuels (Moses 2008)

Thermal Stability

Table 5.6 shows the break point values of the 50/50 fuel blends. Thermal stability of the SPK fuels high, naturally the SPK fuel 50/50 blends have very good thermal stability values. This high break point temperature is due to the lack of impurities. The exact break point temperature is not measurable due to the temperature of the aluminum JFTOT tubes.

Figure 5.5 represents the JFTOT deposit thickness of the Jet-A, SPK fuel and SPK fuel 50/50 blend. This deposit values are in 'nm' with respect to the different temperature values. There is a positive correlation exists between the temperature and the deposit. These results of different kind of fuels and their blends are shown to compare the thermal stability of the different kind of fuels. From the result, it is clear SPK fuels can be blended with the other Jet fuels to increase their thermal stability (Moses 2008).

Table 5.6 Thermal Stability of 50/50 SPK Fuel Blend (Moses 2008)

SPK Fuel	JFTOT Break Point , °C 50/50 Blend
Sasol IPK	>300*
S-8	325*
Shell GTL	290
Sasol GTL-1	285
Sasol GTL-2	295

* Testing stopped at temperature mentioned due to testing tube temperature limitation

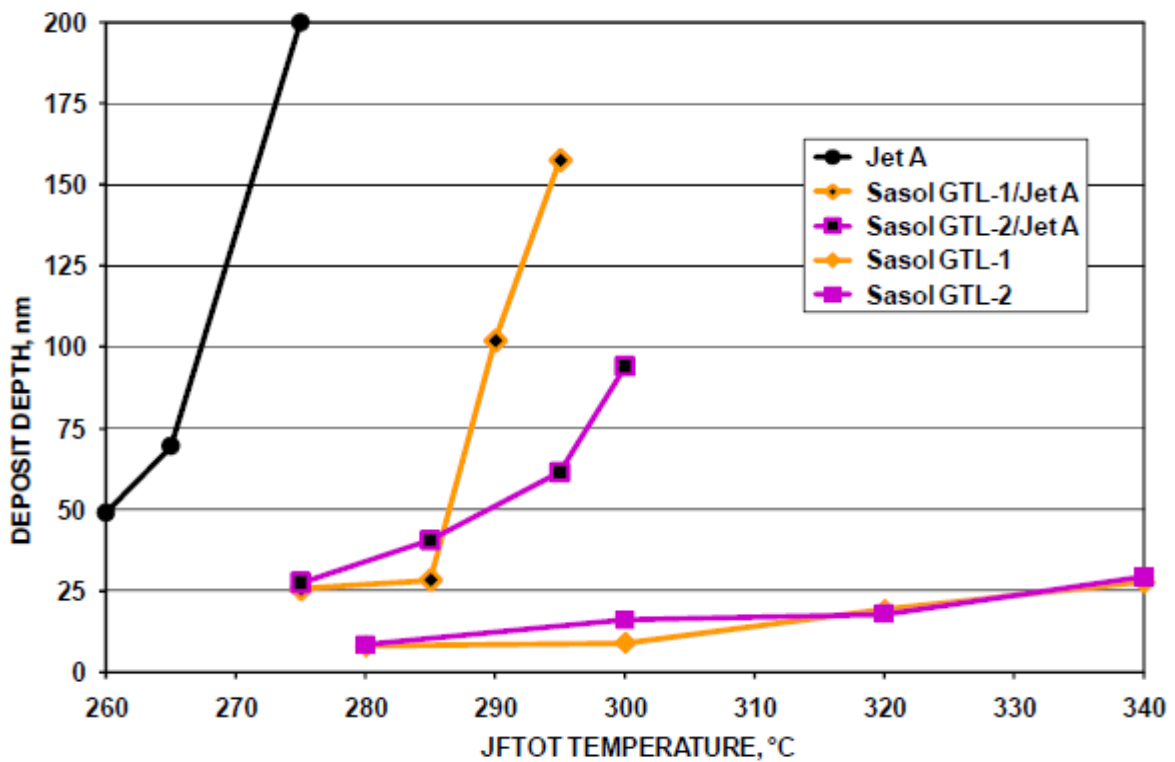

Figure 5.5 Effect of Blending of JFTOT Deposit Characteristics (Moses 2008)

Density

Figure 5.6 shows the density distribution of SPK fuel blends with respect to temperature. From the Figure 5.6, it can be clearly seen that the blends Shell GTL/Jet-A and Sasol GTL-1/JP-8 has the density values below the specified limits. Both these Shell GTL and Sasol GTL-1 have the lowest density values, the values are mentioned in the Table 5.4. Therefore, it's not

possible to achieve 50/50 blending ratio for these both fuels. Nevertheless, it can be used when the blend ratio decreased to some value to get certified without any problem (**Clifford 2008**).

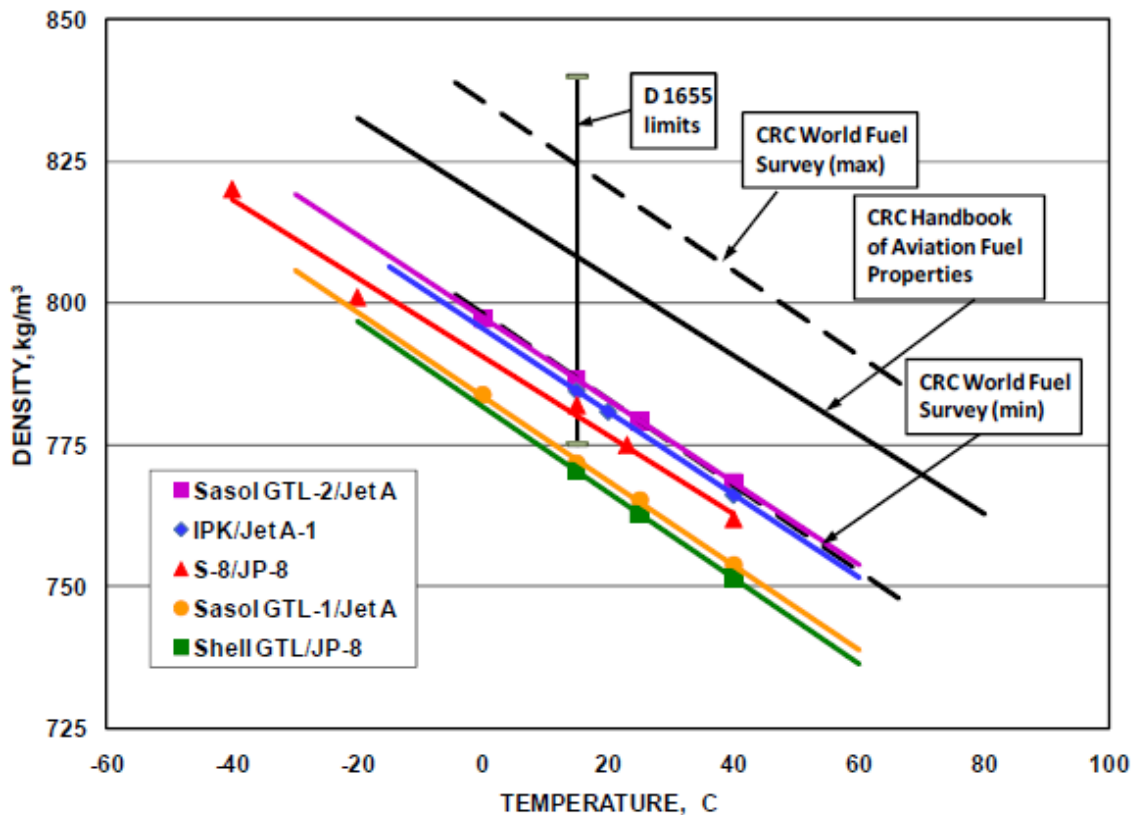

Figure 5.6 Density Distribution of 50/50 SPK Fuel Blends (**Moses 2008**)

Lubricity

Synthetic fuels do not contain any organic acids also; purity level of fuel is very high. High purity results in low lubricity for the synthetic fuels. To overcome this, external additives can be added to increase the lubricity of the SPK fuel blends. There are no special requirements for the lubricity for the commercial Jet fuel, so it is not sure the corresponding blending fuel contains enough lubricity with it is blended with SPK fuel. There is a reason special requirement was placed on the SSJF by DEF STAN 91-91 (Defense Standard) a maximum lubricity rating 0.85mm WSD (wear scar diameter). Figure 5.7 explains the BOCLE (Ball-On-Cylinder Lubricity Evaluator) lubricity rating with respect to the corresponding amount of DCI-4A (Corrosion Inhibitor). DCI-4A responds well to the SPK and to its blends. Addition of only 5 mg/L in the fuel reduces the BOCLE WSD closer to 0.1mm. This value is well enough to get the fuel certified. From Figure 5.7, its clear addition of DCI-4A more than 5 mg/L doesn't make big difference in the BOCLE WSD value.

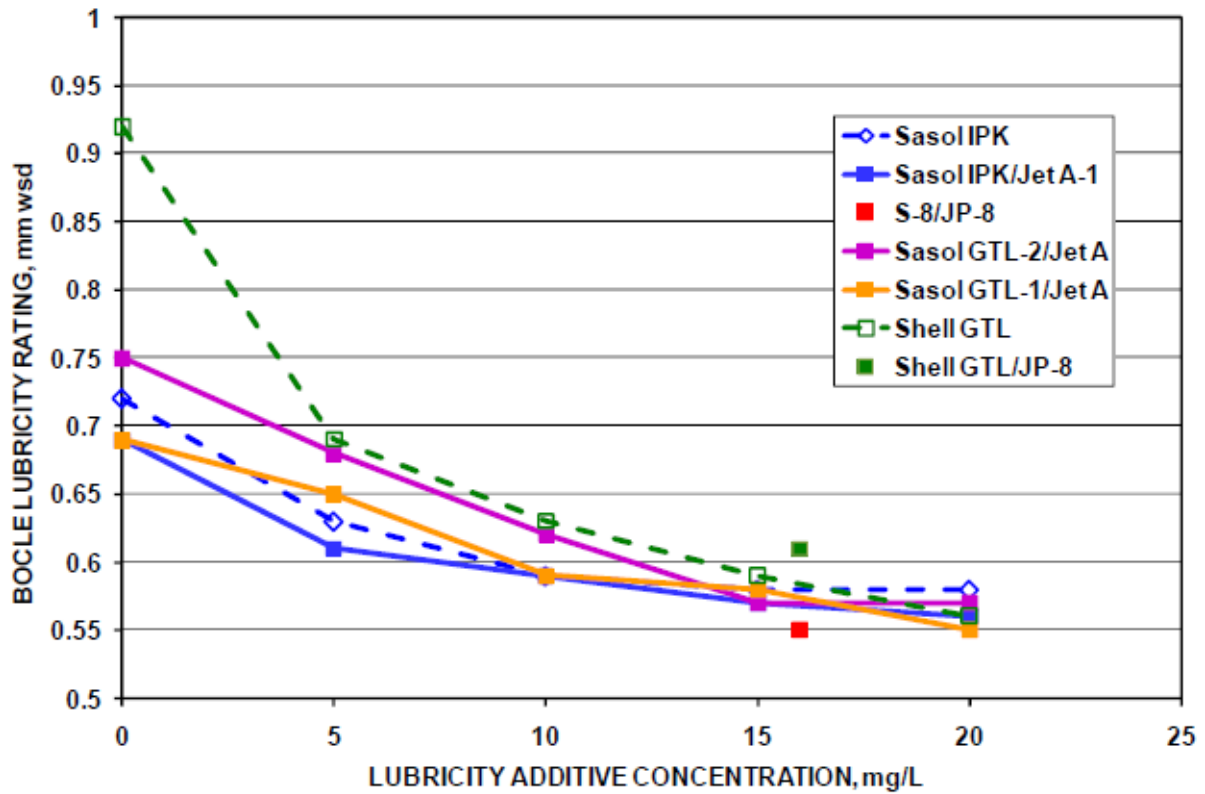

Figure 5.7 SPK Fuel and its Blends Response over Lubricity Improver Additive (Moses 2008)

From the above test results it is clear that synthetic fuels produced from different kind of initial sources like biomass, coal, natural gas or sun to liquid used to produce syngas does not make any difference because in all the above processes resultant is syngas and which is going to be processed in F-T reactor in the following steps. The resultant from F-T reactor synthetic fuel can be blended up to 50% with the normal Jet fuels. Only the low density of the synthetic fuels makes an issue. By altering the blending ratio this problem is solved.

6 Aircraft Design for Bio Jet Fuel and Synthetic Jet Fuel

The advantage of bio and synthetic fuels are mainly that no major structural modifications or propulsion system modifications are needed in aircraft design. In addition, fuel transportation and the storage of fuels are almost similar to conventional jet fuels so, the same system can be followed and the airport infrastructure remains same. This makes the bio and synthetic jet fuels as a major option for the aviation industry. In chapter 5, some of the synthetic fuels are considered as an option and the certification process explained these fuels show the similar properties like an ordinary jet fuel apart from the density imitations and heat capacities of it. In order to solve this issue we can alter the blending ratio so that the density and heat capacity problem can be solved meanwhile, by doing minor changes in the fuel tanks and engines also we can overcome this problem. This change in the aircraft carried out mainly to increase the blending ratio of the alternative fuel even more. This chapter focuses on the possibilities to solve these issues with the help of Aircraft Design.

6.1 Low Calorific Value (LCA) of Alternate Fuels

Lower calorific value of a fuel portion is defined as the amount of heat evolved when a unit weight (or volume in the case of gaseous fuels) of the fuel is completely burnt and water vapor leaves with the combustion products without being condensed (KTH 2014). Figure 6.1 shows the relation between LCA and the density of a fuel for a few numbers of fuels [10, 2867]. In the graph, a horizontal line has been drawn at 42.8 MJ/kg to show the minimum limit for aviation fuel. Two vertical lines are drawn to show the current density specification limits at 775 kg/m³ and 840 kg/m³. In the aircraft turbine industries, they have Wobbe index (I_w) to know difference between the alternative fuel and the design fuel. Equation 6.1 shows the Wobbe index I_w . Lines of constant for Wobbe index -0.05 or +0.05 is shown in Figure 6.1 this is for jet fuels.

$$I_w = LCV / \sqrt{SG} \quad (6.1)$$

LCV Low Calorific Value

SG Specific Gravity

I_w Wobbe Index

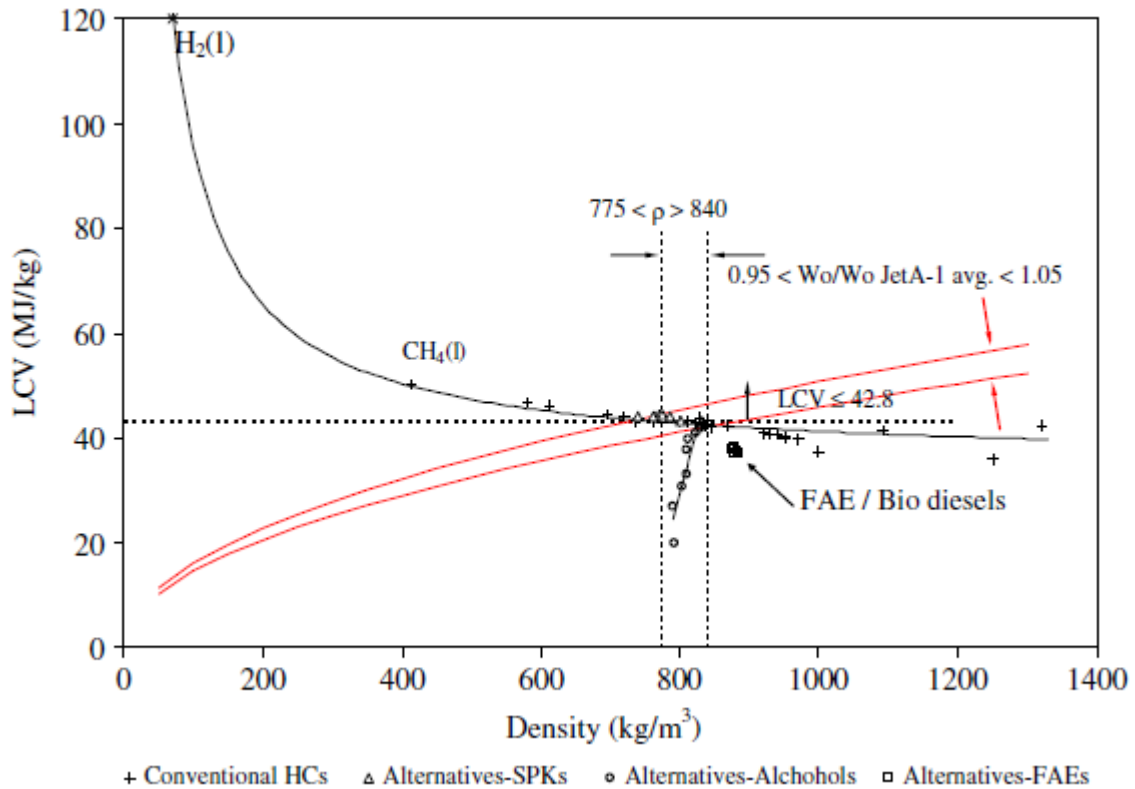

Figure 6.1 Relationship between LCV and Density for Different Types of Alternative Fuels (KTH 2014)

When a fuel contains high LCV and high density would be most desirable for flight, it offers the maximum energy release per unit volume and per unit mass. This directly influence in the aircraft operation. This high LCV and density fuels provide very good range for the aircraft and the volume required for fuel is less. This makes the fuel tank to be smaller and it directly reduces the wing size. Smaller wing size means less drag.

6.2 Payload Range Diagram

In order to understand the alternative fuels and its performance when it's used in the aircraft, respective aircraft range payload diagram can be used. Different alternative fuels can be evaluated using this payload range diagram. Figure 6.2 shows the generic payload range diagram. This payload range diagram is based on equation 6.2. It is important to have an idea about the payload range diagram before it can be analyzed for the alternative fuels.

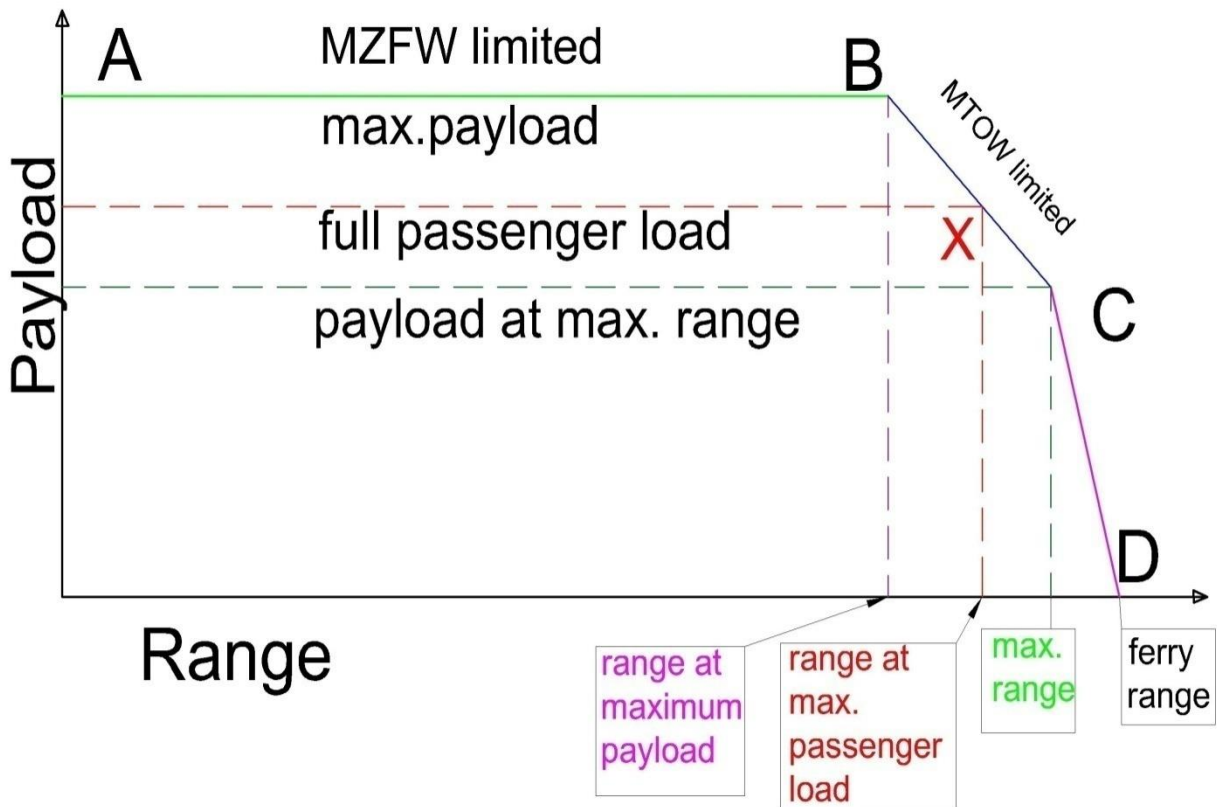

Figure 6.2 Generic Payload Range Diagram (Scholz 1999)

$$m_{TO} = m_{OE} + m_F + m_{PL} \quad (6.2)$$

- m_{TO} Take of mass
- m_{OE} Operating empty mass
- m_F Fuel mass
- m_{PL} Payload mass

An aircraft must not exceed maximum payload m_{MPL} . This will create more bending moment in the wing root. Aircraft will face difficulties in landing due to its heavy weight.

Point A, range is equal to zero, take of mass is equal to maximum zero fuel mass, m_{MZFW} .

Point B, Maximum take off mass, m_{MTO} may not be exceeded.

The fuel mass is, $m_F = m_{MTO} - m_{OE} - m_{MPL}$.

The fuel yields the range at maximum payload. Payload gets exchanged for fuel, more fuel for longer range but fewer payloads.

Point C, maximum fuel mass m_{MF} is on-board. Payload at this point is payload at maximum range and it can be calculated from, $m_{PL} = m_{MTO} - m_{OE} - m_F$.

The maximum range for the commercial flights.

Point D, importance for the ferry flights (no payload)

Point X, Range at full passenger payload.

Figure 6.3 shows the payload range diagram for the Boeing 747-200B for a range of hydrocarbon fuels. Some fuels are in use by aviation industries and some fuels are chosen to indicate the curve in Figure 6.1. For low density and high calorific value fuels, the range limit for all possible payloads is totally limited by the volume of the fuel tanks. By considering the density and calorific value issues, where the maximum structural load is not met by the weight of the elements in Equation 6.1 lead to inefficiencies, this clearly says this fuel is not recommended for the flight cycle. The optimization of aircraft design based on fuel type and based on the calculations, none of the existing aircraft will be able to fly with the liquid hydrogen or liquid methane. Because in order to fly, these aircraft must carry enough fuel for the takeoff and landing and by the FAA regulations enough fuel to reach the alternative airfields during emergency. It requires huge fuel tanks hence it changes the entire structure (**Blakey 2011**).

When density of the fuel is high then the range can be extended by adjusting the payload and fuel weights, to reach the maximum structural limit of the aircraft. At higher densities $>920 \text{ kg/m}^3$ fuel can be stored in fuel tanks without any space problem but the calorific value of the fuel is decreasing so it will result in loss in range. Through comparing conventional hydrocarbon fuels, some fuels perform very well than the kerosene at maximum payload, especially, in density range of 560 to 775 kg/m^3 . These fuels give little bit increase in range. The percentage of the increase in range at maximum payload, by changing the hydrocarbon fuel is small though the greatest increase is around 1.2% (**Blakey 2011**).

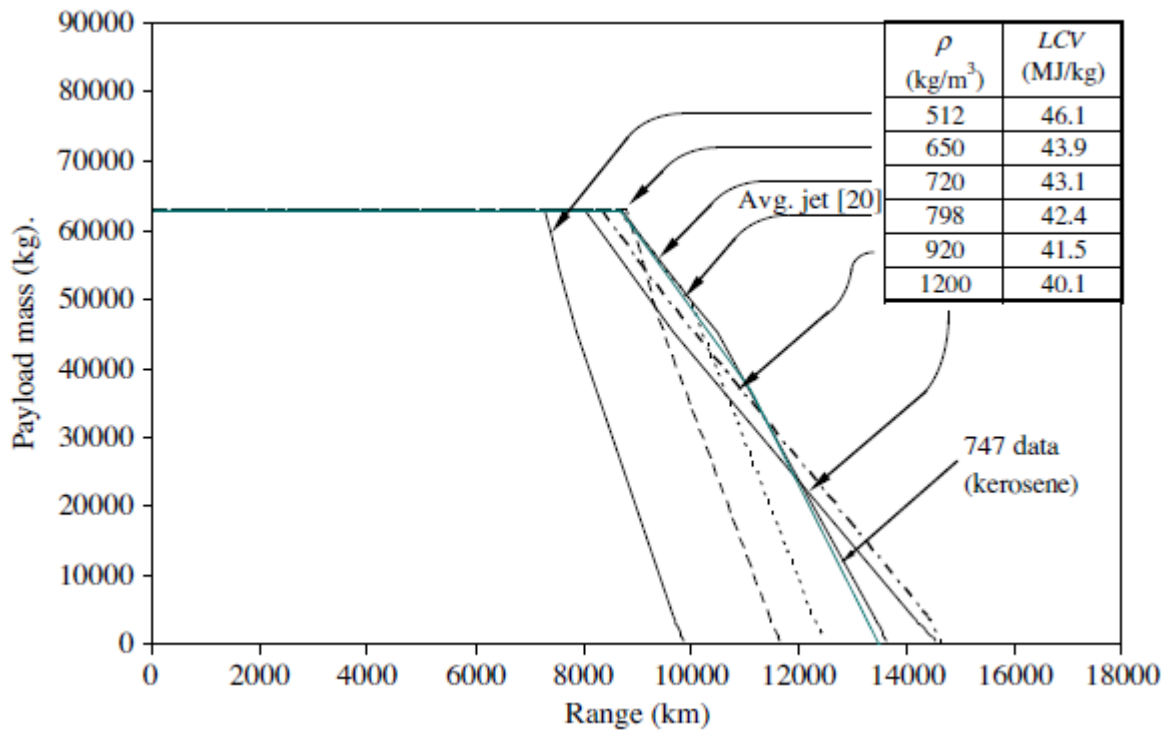

Figure 6.3 Payload Range Diagram for Boeing 747-200B Flying with Distorted Hydrocarbon Fuel (**Blakey 2011**)

Figure 6.4 shows the payload range diagram for many other possible fuels (**Blakey 2011**). These alternative fuels were chosen based on their recent developments and the test flight was conducted recently. The alternative fuels are Alcohols, FAME (Bio jet fuels), SPK (Synthetic jet fuels). It is not possible to use SPK directly so it's blended with kerosene or other synthetic hydrocarbons to meet specifications and the performance of the SPK blend is little bit closer to the conventional kerosene.

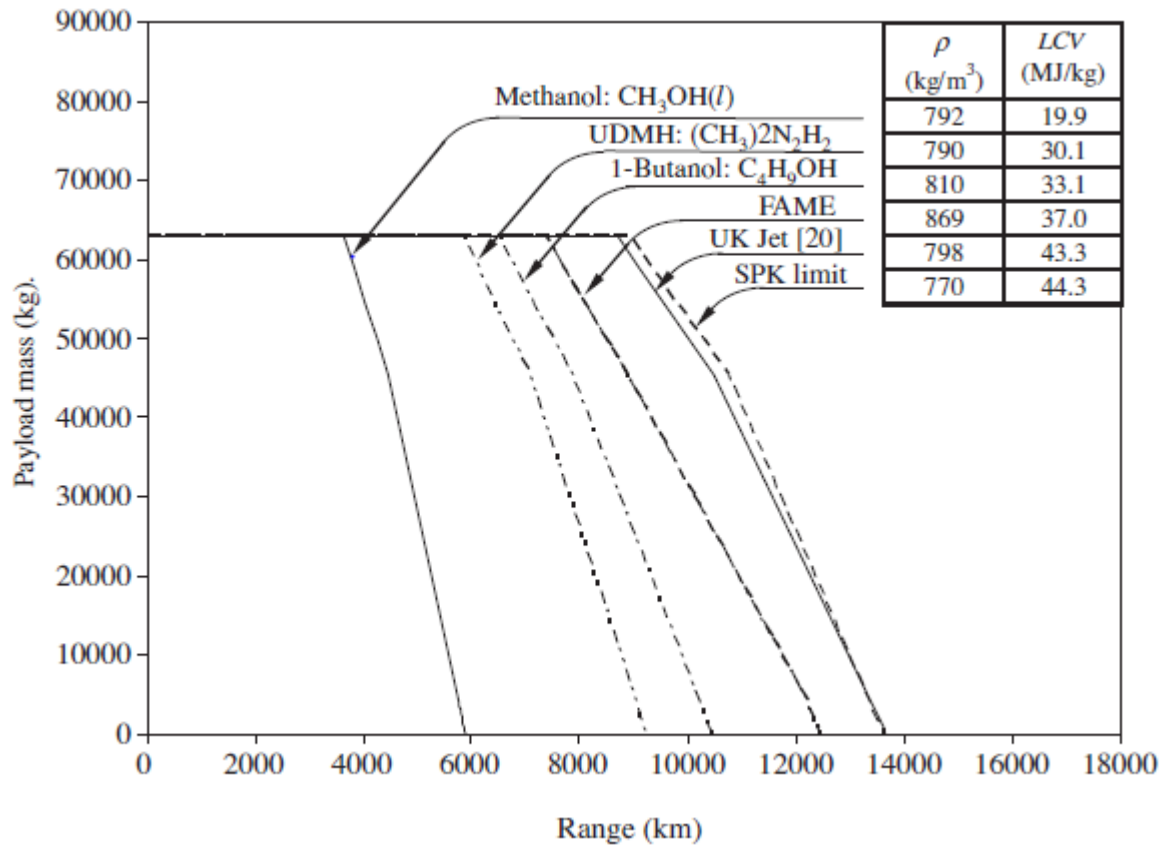

Figure 6.4 Payload Range Diagram for Boeing 747-200B with Alternative Fuels (Blakey 2011)

6.3 Design Appraisal for Alternative Fuel Aircraft

In order to realize the problems in real time flight with the low density and LCA fuels, Boeing 737 sized airplane is modified in such a way it can fly with Ethanol. Figure 6.5 shows the modified Ethanol powered aircraft. Handling and storing ethanol is easier. Unlikely, performance of the ethanol is very bad than Jet A fuel. Ethanol requires 64% more storage volume for the same amount of energy produced by kerosene. In order to make place available for the fuel aircraft wing has been modified to 25% bigger. This results in 20% more operating empty weight. This makes the takeoff weight of the airplane to 35% more than the Jet A fueled airplane. Because of this additional weight, aircraft engines have to be replaced by 50% more thrust providing engine. All these factors added together results in an aircraft that needs 15% more energy for a 500 nmi mission. For the long-range mission ethanol fuel is heavy and efficiency decreases because of additional weight all added together it needs 26% more energy on a 300 nmi mission. This fuel tank problem and LCV make the gaseous fuels unattractive for the aviation industries (Daggett 2006). When thinking about ethanol powered aircraft design, all problems added up together and resulting in a 'snow ball effect'.

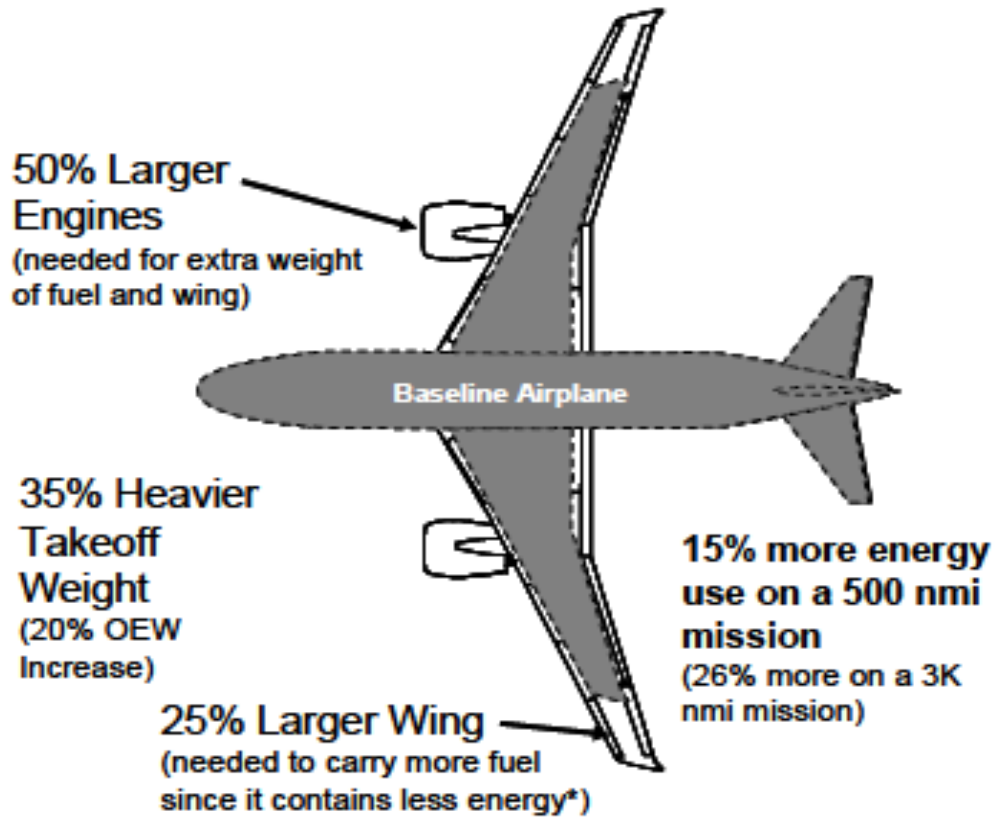

Figure 6.5 Ethanol Powered Aircraft (Daggett 2006)

7 Life Cycle Assessment

Production of bio jet fuel is increasing from the various feed stocks to fulfill the supply demand. A feedstock varies up on the local weather and nutrient conditions of the soil for different region. As the industry trying to adopt for the use of bio fuels from the various feedstocks, production and conversion processes, it is important to determine the carbon emission level of the full production process of the bio fuel. Carbon emission level has to be lower than the conventional fuel; otherwise, it will increase the GHG emission.

The whole GHG emitted during its production, transportation and combustion added for the LCA. It is also known as "Well to Wake". Mostly, the last two operations are same for all the feedstock but production process varies for each feedstock. Therefore, the GHG emission is directly depend on the source of the bio jet fuel.

In order to compare the GHG emission between conventional fuel to the bio jet fuel and synthetic fuel LCA for both the fuels are calculated. Table 8.1 shows the pathways for the different kind of fuels. It considers the source, feedstock, recovery, processing and final product. In addition to this carbon emitted during the combustion is calculated. To find the GHG emission CO₂ emitted during production and combustion added.

There are certain tools available for the LCA. The most common tool is Greenhouse gases Regulated Emission and Energy in Transportation (GREET). GREET applies with various fuel pathways. Besides GREET, other life-cycle assessment (LCA) models are available, e.g. SimaPro, Canadian GHGenius, E3 database and Eco balance by Price Waterhouse Coopers in Europe and Life-cycle Emission (LEM) model by University of California, Davis.

Due to the lack of sources in internet there is no standard LCA done for the STL and PTL processes. These processes are still in laboratory scale. However, these technologies definitely reduce the GHG emission and it will overcome the problems related to finding the natural sources for producing syngas.

Table 7.1 Fuel Pathways for LCA (Wong 2008)

Source	Feedstocks	Recovery	Processing	Final Product
Petroleum	Conventional crude	Crude extraction	Crude refining	Jet fuel
	Conventional crude	Crude extraction	Crude refining	ULS jet fuel
	Canadian oil sands	Bitumen mining/extraction and upgrading	Syncrude refining	Jet fuel
	Oil shale	In-situ Conversion	Shale oil refining	Jet fuel
Coal	Coal	Coal mining	Gasification, F-T reaction and upgrading (with and without carbon capture)	F-T Jet fuel
Natural Gas	Natural gas	Natural gas extraction and Processing	Gasification, F-T reaction and Upgrading	F-T Jet fuel
Biomass	Biomass	Biomass Cultivation	Gasification, F-T reaction and upgrading	F-T Jet fuel
	Renewable oil (soy oil)	Biomass cultivation and extraction of plant oils	Hydrotreating	Biojet
	Renewable oil (palm oil – from South-east Asia)	Biomass cultivation and extraction of plant oils	Hydrotreating	Biojet

7.1 Petroleum Fuel LCA

The main factors that have to be considered in the petroleum based fuels are:

1. Crude oil recovery and transportation
2. Processing of crude oil into jet fuel
3. Transportation of jet fuel
4. Combustion

REET evaluates two sources of crude oil: conventional crude oil and synthetic crude from Canadian oil sands. The GHG intensities of these crude types are quite different because of the differences in recovery techniques and the amount of methane vented and flared in recovery. The efficiency of conventional crude recovery is estimated at 98%, while the majority of GHG emissions in this stage results from flaring and venting of associated gas.

For Canadian oil sands recovery, both surface mining and in situ production are considered. The share of surface mining is estimated to be 50% in 2010. Oil sand recovery consists of the extraction and treatment (upgrading) of bitumen in oil sand fields. The extraction efficiencies of surface mining and in situ production are estimated to be 94.8% and 84.3%, respectively. In addition, the upgrading efficiencies of bitumen from surface mining and in situ production are estimated to be 91% and 95.6%, respectively. A large amount of H₂ is required for upgrading bitumen (86% and 70% of total process fuel in surface mining and in situ production, respectively). CH₄ emissions in tailing ponds are another source of GHG emissions associated with oil sands recovery (**Han 2013**).

Overall refinery efficiency is defined as

$$\eta_o = E_{\text{products}} / E_{\text{inputs}} \quad (7.1)$$

Where, η_o = petroleum refinery energy efficiency,

E_{Products} = Energy in all petroleum products,

E_{Inputs} = Energy in crude input, other feedstock inputs, and process fuels used

The jet fuel specific refining efficiency was derived from the overall refinery efficiency using the kerosene relative energy intensity (**Stratton 2010**). Relative energy intensity was defined as "the ration of total energy use share to the mass share of a given fuel". It provides a measure of how energy intensive of more than 100% for a particular fuel means that the production of that fuel uses up a greater share of overall process energy than the mass share of that fuel produced.

The refinery energy efficiency of jet fuel was calculated from the overall refining efficiency and the product's relative energy intensity (**Wang 2004**):

$$\eta_s = \frac{1}{1 + \chi_s \left(\frac{1}{\eta_o} - 1 \right)} \quad (7.2)$$

From the above equation, the refining energy efficiency of jet fuel is about 93.5%. This refining efficiency was used in the baseline case for the life-cycle analysis of GHG emissions in the production of jet fuel from conventional petroleum.

7.2 Bio Jet Fuel LCA

For biojet fuel pathways, biomass farming, oil seed farming, oil extraction and HRJ fuel production stages generate the majority of GHG emissions. Common feedstocks for the bio jet fuel production soybean, palm, rapeseed, algae, jatropha and salicornia. Major sources of GHG emissions in oil seed farming include nitrogen fertilizer and fossil fuel use. Nitrogen fertilizer use is a major source of GHG emissions, not only because of its emissions of N₂O from the nitrification and denitrification of nitrogen fertilizer in fields, but also because a large quantity of NG is used during its production. For the oil extraction stage, oil yields are important and depend on the lipid content of oil seeds. The lipid content of soybean (18.5%) is much lower than that of other oil seeds (e.g., compared to 44% in rapeseed). However, soy oil extraction co-produces a large amount of soy meal, which is a valuable animal feed that results in significant GHG emissions credits. Fossil fuel use in oil extraction, such as NG (Natural Gas) and coal, is also a substantial source of GHG emissions, especially when the GHG emissions associated with NG and coal production and distribution (such as methane leakage and venting emissions) are taken into account (**Han 2013**).

Soybeans, palm and rapeseed are edible food crops requires farmland for cultivation. This will increase the price of the oil due to the lack of sources. With the current technology, it is only possible to measure the emissions from transportation and production is possible. Direct and indirect emissions during land use change also affect the GHG emission. Figure 8.1 shows the typical processes involved in production of biojet fuel.

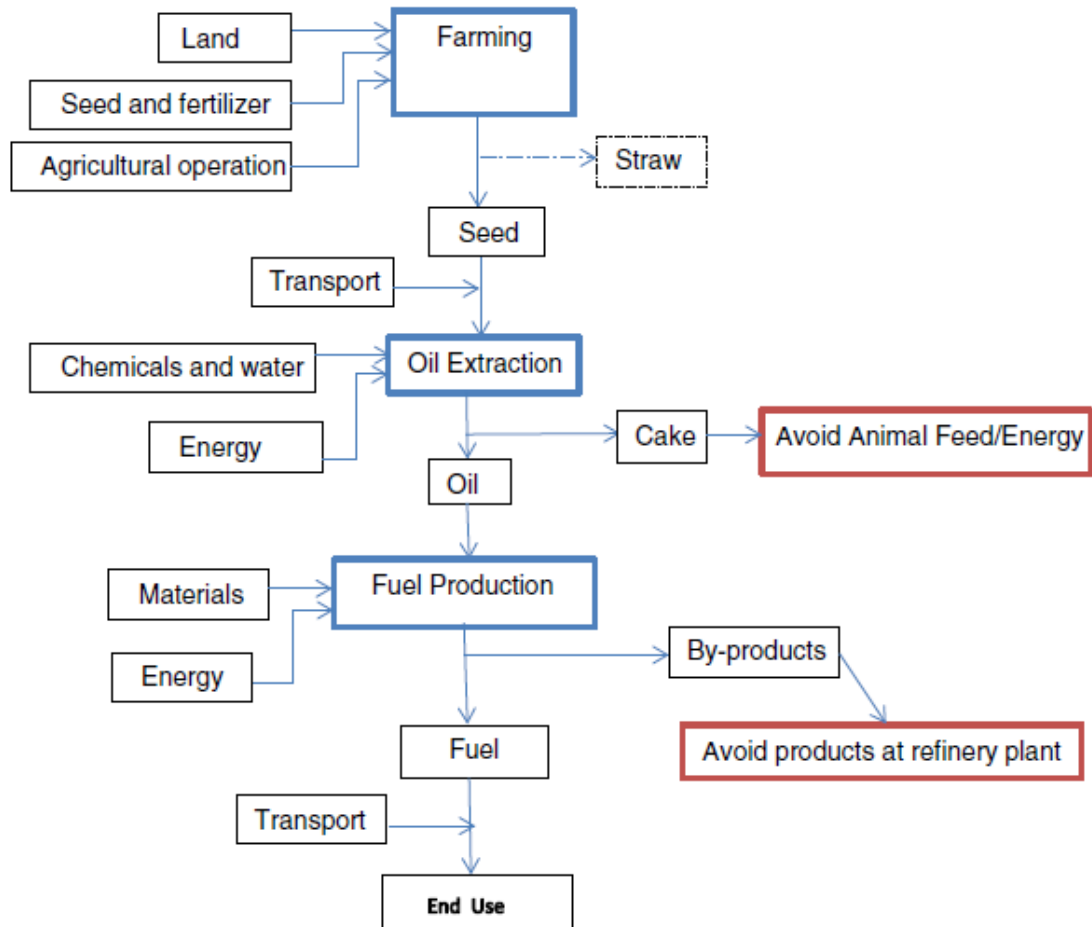

Figure 7.1 LCA for Bio Jet Fuel Production (Li 2014)

Different production methods exist for the micro algae production. With every production method, also the LCA changes. The main three production methods are,

1. Effluent-cultivated algae, followed by whole-cell Pyrolysis
2. Raceway culture of saline-tolerant algae, followed by oil extraction and hydro processing
3. Raceway culture of saline-tolerant algae, followed by whole-cell Pyrolysis

Lot of energy needed to process the biomass produced from algae. Concentration of biomass is an important factor in terms of LCA. There are two different methods based on the concentration level of the biomass in the water.

1. Centrifugation and Thermal evaporation
2. Dissolved air flotation (DAF)

For less than 1% to 10% solids, Centrifugation and thermal evaporation method is used. This method needs minimum chemical and electricity usage. DAF methods relying on the air bubbles pumped in to the dewatering tank. To generate air bubbles system needs huge

pumps. Use of this system alone increases the life cycle GHG emissions by 50.2 g CO₂eq/MJ fuel product (**Handler 2014**).

7.3 Synthetic Fuel LCA

The main sources for the synthetic fuels are Natural gas, Coal, biomass. GTL is the most common technique in use compared with coal and biomass. The FT process efficiency is a key parameter affecting the life cycle GHG emissions of the production of FT jet fuel from natural gas. The range of FT process efficiencies estimated from 60% ... 65% (**Wong 2008**). In FT process, LCA measured with the carbon capture and sequestration (CCS) is present in the plant or not. This directly affects the GHG emission.

Gas to Liquid

The GTL pathway is GREET and well documented based on current industry data. Specifically, this analysis assumed non-North American natural gas was supplied to an internationally located stand-alone FT liquid fuels plant designed to maximize liquid fuels production (e.g. through recycling of tail gas from FT reactors). Already enough sources are in Chapter 4.1.5 about the FT process. Sufficient electrical energy was produced to fuel all internal processes, with negligible excess electricity produced for export.

The process included the upgrading (hydroprocessing) of long-chain liquids to a final product slate of diesel (C₁₈), jet fuel (C₁₂) and naphtha (C₄-C₆). The energy allocation method was adopted for assigning energy and emissions to various liquid products. To produce jet fuel instead of diesel, additional hydrocracking and greater syngas recycle are needed, resulting in a small increase in hydrogen and power requirements for the plant. Furthermore, a moderate decrease in the CO₂ associated to jet fuel compared to diesel would ensue due to changes in the allocation fractions. As these additional energy requirements do not lead to substantial increases in CO₂ emissions from the facility, they were ignored in this analysis, (i.e. the production of FT jet fuel is assumed to have the same emissions as the production of FT diesel). This assumption applies to all of the FT jet fuel pathways analyzed in this study, namely the production of FT jet fuel from natural gas, coal and biomass. Although FT jet fuel can be made without added burdens, it is not possible to have a product slate of 100% FT jet fuel (a value of 25% is taken as the preferred value in these studies, and a sensitivity study is shown for a co-fed coal and biomass FT facility).

The FT process efficiency is a key parameter affecting the life cycle GHG emissions of the production of FT jet fuel from natural gas. Equation 4 defines process efficiency for a general FT facility. GTL process efficiencies from the literature vary from 60% to 65%.

$$\text{Process Efficiency} = \frac{1 \text{ MJfuel}}{1 \text{ MJfeedstock} + \text{Process Energy}} \quad (7.3)$$

The low emissions, baseline and high emission scenarios assumed LHV (Lower Heating Value) process efficiencies of 65%, 63% and 60%, respectively. The important assumptions and corresponding life cycle GHG emissions in the production and use of FT jet fuel from natural gas are shown in Table 8.2. The life cycle GHG emissions of the FT jet fuel (production and use) made from natural gas range from 1.14 times to 1.17 times higher than the conventional petroleum-based jet fuel.

Table 7.2 Summary of Inputs and Results for FT Jet Fuel from Natural Gas Pathway (**Stratton 2010**)

	Low	Baseline	High
Key assumptions			
Process efficiency (LHV)	65%	63%	60%
Life Cycle CO2 Emissions by Stage			
Recovery of feedstock (gCO2/MJ)	4.6	4.6	4.6
Transportation of feedstock (gCO2/MJ)	0	0	0
Processing of feedstock to fuel (gCO2/MJ)	19.4	20.2	21.4
Transportation of jet fuel (gCO2/MJ)	1.2	1.2	1.2
Combustion CO ₂ (gCO2/MJ)	70.4	70.4	70.4
WTT GHG Emissions by Species			
WTT CO ₂ emissions (gCO2/MJ)	25.2	26	27.2
WTT CH ₄ emissions (gCO _{2e} /MJ)	4.4	4.6	4.8
WTT N ₂ O emissions (gCO _{2e} /MJ)	0	0	0
Total WTW GHG Emissions (gCO_{2e}/MJ)	100.1	101.0	102.4
Life Cycle GHG Emissions Relative to Baseline Conventional Jet Fuel	1.14	1.15	1.17

Carbon Capture and Sequestration (CCS)

By comparison, to conventional power plants, FT plants are well suited for the implementation of carbon capture and sequestration (CCS). This opportunity occurs because the FT process results in a relatively pure stream of CO₂ upstream of the FT synthesis step, whereas coal power plants produce flue gas, which must be scrubbed to obtain a pure CO₂ stream (Stratton 2010).

The amount of carbon available for capture is equal to the difference between the carbon present in the feedstock and the carbon present in the final products. The term carbon capture efficiency is used to define the percentage of available carbon that is actually captured. Capture efficiencies of 80%, 85% and 90% were assumed for the high emissions, baseline and low emissions cases, respectively. Recent analyses at National Energy and Technology Laboratory (NETL) have indicated that capital expenditures associated with systems designed to capture CO₂ at the 80% level would not vary significantly from those capturing at the 90% level. A capture efficiency of 85% was chosen for the baseline case in this work to reflect the lack of commercial experience surrounding widespread implementation of CCS. Carbon emitted from the combustion of process fuels is not captured.

Coal to Liquid

This work examined the life-cycle GHG emissions of the production of FT fuels from coal for the case without capture of carbon dioxide and the case with capture. In the case of a coal-to-liquids (CTL) plant with carbon capture, this work assumed that the energy needed for the separation and compression of carbon dioxide was provided by the electrical power generated in the FT process, instead of from the grid. This resulted in a reduction of the overall process efficiency. A relatively large range of values for process efficiency can be found in the literature, ranging from below 40% to about 60%, for plants utilizing different technologies, feedstocks, scale, and configurations (e.g. whether designed for maximizing liquid fuels production or with substantial electricity production for export).

Table 7.3 Variation of Life Cycle GHG Emissions with FT Process Energy Efficiency (**Wong 2008**)

Process Energy Efficiency (%)	Life-Cycle GHG Emissions (gCO ₂ e/MJ)	Compared to Baseline Conventional Jet Fuel
40	243	2.9
50	195	2.3
60	162	1.9

Table 7.3 varying process energy efficiency could result in overall GHG emissions ranging from less than 2 times those of conventional jet fuel to almost 3 times higher. For the scenario analysis, process efficiencies of 60%, 50% and 40% were assumed for the low, baseline and high emission cases for a CTL plant without carbon capture, respectively. For the case of a CTL plant with carbon capture, as in the case of the GTL plant with carbon capture, it was assumed that the energy needed to separate and compress the carbon dioxide for subsequent transportation and sequestration was provided by electrical energy by internal processes instead of the grid. This resulted in a reduction in the overall process efficiency.

Biomass to Liquid

The biomass feedstock include waste biomass (e.g. forest residue, agricultural residue) and non-food energy crops (e.g. herbaceous biomass) that were assumed to be grown on land that would not incur adverse direct or indirect land use change emissions (e.g. idle or abandoned cropland). Specifically, three types of biomass feedstocks were considered: switchgrass, corn Stover and forest residue (**Stratton 2010**). A sensitivity analysis was carried out to investigate the effect of varying feedstock type (switchgrass, corn stover and forest residue) and the influence of changes in soil carbon due to switchgrass growth or corn stover removal on the overall life cycle GHG emissions of the BTL pathway.

Table 7.4 Summary of Inputs and Results for FT Jet Fuel from Biomass Pathway (Wong 2008)

	Low	Baseline	High
Type of Feedstock	Corn Stover	Forest Residue	Herbaceous Biomass
Process Efficiency (%)	60	45	40
WTT CO ₂ Emissions (gCO ₂ /MJ)	5.5	11.2	2.6
WTT CH ₄ Emissions (gCO _{2e} /MJ)	0.15	0.32	0.27
WTT N ₂ O Emissions (gCO _{2e} /MJ)	-0.2	0.1	11.4
WTT GHG Emissions (gCO _{2e} /MJ)	5.4	11.6	14.2
Combustion CO ₂ (gCO ₂ /MJ)	0	0	0
Total WTW GHG Emissions (gCO _{2e} /MJ)	5.4	11.6	14.2
Total WTW GHG Emissions Relative to Baseline Conventional Jet Fuel	0.06	0.14	0.17
Overall Energy Ratio	0.57	0.42	0.38

FT fuels also burn more cleanly than conventional jet fuel and could help to reduce aviation's impact on air quality. However, it is important to keep in mind that high levels of reduction in GHG emissions can only be achieved with the use of biomass feedstocks, which do not contribute adversely to CO₂ emissions from land use changes, as was assumed in this analysis of this fuel pathway. The use of waste products such as forest residues or crop residues is an obvious way to circumvent the possible negative effects of emissions from land use changes. However, the use of waste products is limited by their availability, both within a reasonable distance from the BTL plant and arising from seasonal and behavioral fluctuations, which in turn limits the scale of BTL production. This resource limitation is further exacerbated by the large biomass feedstock requirement per mass of fuel produced. For example, assuming that 6 tons of forest residue feedstock is required to produce each ton of FT fuel (as discussed earlier), about 0.02 ton of feedstock would be required per gallon of FT fuel. This means that in order to produce about 25000 barrels a day of FT jet fuel (enough to meet the needs of a large airport), about 20000 tons of forest residue would be required a day, about 5% of current forest biomass production.

7.4 CO₂ Emission Comparison

Conventional (crude derived) and unconventional (tar sands and shale derived) refinement of oil into product is labeled as ‘Jet Fuel’ in Figure 8.2. Further processing during crude refinement produces an ultra low sulphur fuel identified above as ULS jet fuel. FT refers to synthetic kerosene produced via the Fischer–Tropsch process using coal, gas or biomass as feedstock. For simplicity, it is assumed that combustion CO₂ is comparable across fuel types as compositionally all fuels are comprised of similar hydrocarbons (i.e. drop-in fuels) (Blakey 2011).

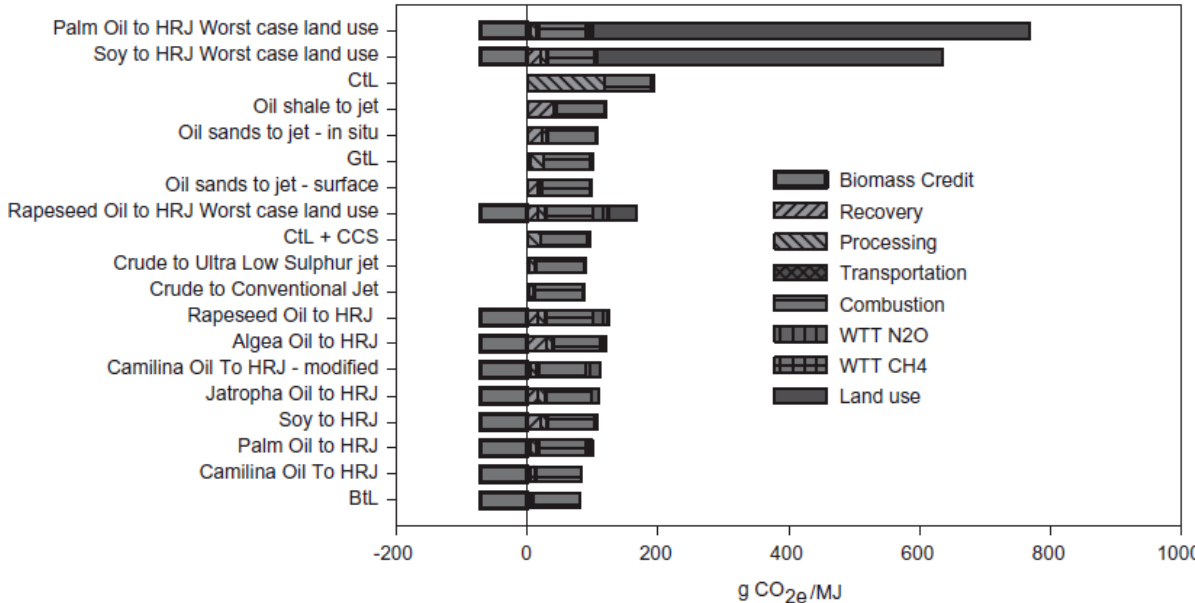

Figure 7.2 CO₂ Equivalent Lifecycle Data for Range of Fuels (Blakey 2011)

The main aspect for the LCA is to address the impact of aviation on climate change with alternative jet fuels. This focus is on one specific aspect in examining the feasibility of using alternative jet fuels and their life-cycle GHG emissions. This involved the quantification of the overall GHG emissions of potential alternative jet fuels, from feedstock recovery and transportation, to the production, transportation and utilization of the fuels. The fuels examined in this work included jet fuel and ULS jet fuel from conventional crude, jet fuel from oil sands and oil shale, F-T jet fuel from natural gas, coal and biomass, and biojet from soy oil and palm oil and Jatropha and algae biomass.

With respect to the varying important input parameters, a range of life-cycle GHG emissions for each fuel pathway was derived in Table 8.5. Values in the table are Relative to Baseline Conventional Jet Fuel (Low Emissions, Baseline and High Emissions Cases).

Table 7.5 Life Cycle GHG Emission for the Different Fuel Pathways (**Wong 2008**)

Fuel Pathway	Life-Cycle GHG Emissions Relative to Baseline Conventional Jet Fuel		
	Low	Baseline	High
Crude to Jet Fuel	0.9	1	1.1
Crude to ULS Jet Fuel	1	1	1.1
Oil Sands to Jet Fuel (Surface Mining)	1	1.2	1.4
Oil Sands to Jet Fuel (In-Situ Production)	1.2	1.3	1.7
Oil Shale to Jet Fuel	1	1.4	1.7
Natural Gas to FT Jet Fuel	1	1.2	1.2
Coal to FT Jet Fuel (Without Carbon Capture)	1.9	2.3	3.2
Coal to FT Jet Fuel (With Carbon Capture)	1	1.1	1.5
Biomass to FT Jet Fuel	0.1	0.1	0.2
Soy Oil to Biojet (Without Land Use Change)	0.4	0.4	0.6
Soy Oil to Biojet (With Land Use Change)	1.1	3.4	7.1
Palm Oil to Biojet (Without Land Use Change)	0.3	0.3	0.4
Palm Oil to Biojet (With Land Use Change)	0.4	1.6	7.6

8 Flight Tests Done with Alternative Fuels

Governments around the world are considering alternative fuels to secure future fuel supplies and to control CO₂ emissions. Generally, fuel derived from biomass is considered as carbon neutral, since the CO₂ absorbed by growing plants is come out into the atmosphere when the fuel is combusted; in actuality, we have to consider the whole life cycle of the process from land clearance, transportation, energy spent for plant growth, production process.

The European Union Renewable Energy Directive (RED) requires reducing greenhouse gas (GHG) emissions by 20 percent in 2020 compared with 1990. To attain this target they require total 6.7 Billion gallons bio fuel production by 2020 (**Campbell 2006**). This kind of government orders and goals promotes airliners to try test flights with bio fuels and synthetic fuel blends. Below listed airlines, successfully carried out test flights and few airlines carried long-term flight schedules by using the bio diesel up to 50 percent blend with fossil fuel.

Lufthansa Airlines

Lufthansa airlines did long term scheduled flight from Hamburg to Frankfurt starting from 15 July to 27 December 2011 with 1,187 flights operated between these locations. One of the aircraft's two engines was operated with 50% biosynthetic kerosene and the other engine was operated with normal fossil fuel. This bio fuel from the energy plants Camelina (80 percent) and Jatropha (15 percent) and animal fats (5 percent). Overall bio fuel consumed 1557 t and reduction in CO₂ emission 1471 t (**GMF 2007**).

South African Airlines

South African Airlines operated from the Johannesburg uses the semi synthetic jet fuel to blend with the normal kerosene fuel for almost fifteen success years and the flights are both domestic and international. Fuel, which is supplied, by Sasol, and it is known as Sasol SSJF. They varied the blending ratio depending on the situation. Most of the time 20% blending was used during shortage of normal Jet fuel blending percentage is increased up to 50%. In the Chapter 5, certification and properties of this SSJF has been explained clearly. South African Airlines had no issues regarding safety, maintenance, airworthiness, storage and handling of the jet fuel blended with appropriate Sasol SSJF stored in bulk tanks.

US Air Force

In 2006, the US Air Force successfully finished 50-hour engine test with TF33 engine. Then, the aircraft B52 used 50/50 blend of S-8 and JP-8 fuels for flight tests and cold weather tests. By using this test results US Air Force certified the B52 aircraft to fly with SSJF. In December 2006, US Air Force certified C17 Globe master III aircraft using a 50/50 blend of Shell GTL and JP-8. In March 2008, US Air Force conducted first supersonic flight test with SSJF in B-1 Lancer aircraft with the Shell GTL as a blend. In August 2008, US Air Force started its flight tests of F-15 and F-22 fighters using 50/50 blends of the Shell GTL with JP-8. F-15 carried out high-speed test, which is greater than Mach 2, and F-22 tests included aerial refueling from KC-135 Stratotanker. After finishing all the tests Air Force has indicated there were no significant difference in the performance, durability, flight safety, ground handling or storage for both the S-8/JP-8 and Shell GTL/JP-8 blends and normal jet fuel JP-8. Properties and details of fuels S-8, Shell GTL and JP-8 are given in chapter 5.

Airbus

In February 2008, an Airbus A380 powered using Rolls- Royce Trent 900 engines made a three-hour flight from Filton, UK to Toulouse, France. Fuel used was Shell GTL and Jet A-1 blend. Due to the density limitation only 37.4%, Shell GTL was used. Data were stored during the flight also engine materials and fuel tanks were tested after the flight, results showed that there were no issues in the aircraft engine and systems and materials. Airbus supports the commercialization of SSJF fuel blends (**Moses 2008**).

Virgin Atlantic

Virgin Atlantic was the first commercial airlines to demonstrate flight on a biomass derived jet fuel (bio Jet). It was between London and Amsterdam on 23 February 2008. This aircraft was Boeing 747-400 one of its four engines was operated with a blend of Jet A-1 and 20% coconut and palm oil. There is no emission data available for this flight, but it is expected that there will be changes in the emission gases. After this flight, Boeing provided a statement FAME fuel used in the Virgin flight was the only suitable bio fuel available at that time and this fuel is not a promising option for aviation. The data about the engine condition after flight is unavailable (**Blakey 2011**).

Air New Zealand

In order to increase the availability of feedstocks and to avoid food productivity problems they focused on the inedible oil seeds. On 20 December 2008, test flight was carried out between Auckland and Wellington (New Zealand), with the Boeing 747-400 aircraft. One of the four engines was fueled with 50/50 bio Jet fuel and Jet A-1. Engine parameter analysis after flight shows fuel burn saving of 1.2%, in order to make it sure many flight tests has to be carried out. When going through the energy contents of the Jatropha derived fuel and Jet A-1, it can be understood. Jatropha fuel has 44.3 MJ/kg and Jet A-1 42.8 MJ/kg minimum specification requirement. These successful tests suggest Jatropha derived bio jet fuel can be considered as an option for future (**Blakey 2011**).

Continental Airlines

In Continental airline flight program, in Boeing 737-800 one of the two engines is operated with 50/50 blend of normal jet fuel and a mixture of Jatropha 47.5% and Algae 2.5% fuel. This test was carried out in Houston on 7 January 2009. This is the first airline to fly with the algae fuel. Algae feedstock has the potential to provide higher yield than the other bio fuel feed stocks. However, it is not proved yet in big scale also it hides a lot of mysteries inside.

Qatar Airways

Qatar has one of the biggest GTL plant in world. On October 13 2009, Qatar Airways operated a commercial flight using GTL synthetic jet fuel. This Airline is planning to operate regular commercial flights with the Synthetic jet fuel produced by the Shell- Qatar Petroleum Pearl Project (**Blakey 2011**).

All the airliners, Airbus and Boeing aircraft manufacturers reported no adverse affects on engine and aircraft systems and storage or handling with ground systems. All of them recommended Synthetic fuel and Bio jet fuel made by Hydro processing can be used for both commercial and military aircrafts. Only Boeing have suggested FAME produced fuel is not fit for the aviation. However, they didn't reveal any data about this issue.

9 Environmental Impact

The major carbon-containing component in the atmosphere is carbon dioxide with the concentration increasing at a considerable rate of 0.35% per year (Alexander 2004). Already in Chapter 2 CO₂ emission in the atmosphere and the effects are explained with pictures and example. Methane is another carbon-containing component whose concentration is also increasing at a rate of 1%...2% per year. Methane is a green house gas. Methane may be short-lived relative to carbon dioxide, with an atmospheric lifespan of 12 years; however, it is 21 times more effective than CO₂ as a green house gas, on a weight basis (Howarth 2011). There are lots of different types of sources for the methane emission in to the atmosphere. Figure 9.1 shows the Global methane emission in percentage values (Global Methane Initiative 2010). When methane used as an energy source (for transportation) around the world, emission rate will increase in an unimaginable way.

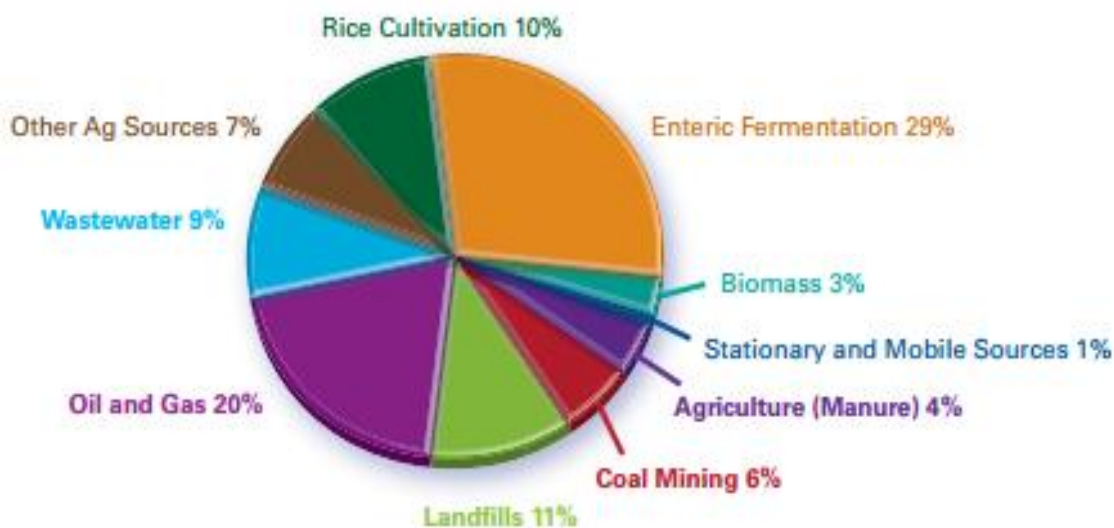

Figure 9.1 Estimated Global Methane Emissions (Global Methane Initiative 2010)

From Figure 4.3 we can see clearly, methane sources are available all around the world. Proper guidelines and rules have to be created to use the hydrate resources. Use of large quantity of methane hydrates in short period will result in huge emission. Destabilization of the hydrates and uncontrolled release of large volume of methane is a significant hazard.

10 Conclusion

Aircraft fuel price increasing steadily in past few years and some scientific researchers suggest that fossil fuel sources are decreasing on the other hand. It is not safe to depend completely on the fossil fuel. It is the time to look for the alternative fuel option and this alternative option has to fulfill the supply demand and the certification requirements. The range of alternative fuels which are suitable for aviation are restricted if the fuel is to be used for all existing aircraft. There are only few fuel options available with the quality to fulfill the supply demand.

Bio fuels and synthetic fuels are best options for the alternative fuels. Bio fuel sources are very limited and the fuel properties do not meet the certification process. Therefore, bio fuel is mixed with jet fuel up to 20% or less than this. Bio fuels contain metal contaminants from the feedstock. This limits its blending percentage with jet fuel. Bio fuels help to reduce the CO₂ emissions and it is the best option for road transportation. The energy content as a function of weight and volume of the fuel has a direct impact on alternative aviation fuel. Energy content has an impact on the aircraft payload range diagram. Due to the high density, bio fuels provide good range compared with synthetic fuels.

Synthetic fuel properties are almost equal to jet fuel so it can be blended up to 50 %. This is proved with many test flight demonstrations with positive results. More research has to be done with synthetic fuel to increase the blending ratio further. Sources for the production of synthetic fuel is available in huge amount (coal, methane). Due to the huge amount of methane hydrates, it can be used as a long-term source for production of methane and methane can be converted with GTL process to synthetic jet fuel.

Main drawback in terms of synthetic fuel are its CO₂ emissions. The CCS technique will reduce the GHG emission level from production meanwhile it will increase the production cost. STL and PTL are very good option for the production of syngas and for the environment. More research in these field will hopefully help to attain this objective soon. Many companies and countries are involved in figuring out a way to extract methane from hydrates safely without affecting the environment. By neutralizing the environmental issues, hydrates can be a promising source for the aviation industries fuel needs. LCA assessment is important in terms of GHG emissions, so proper findings in LCA will help to reduce GHG and to choose the proper sources for the alternative fuels.

References

- Achten 2010** ACHTEN, W.M.J., MAES, W.H., AERTS, R., VERCHOT, L., TRABUCCO, A., MATHIJS, E., SINGH, V.P. and MUYS, B., 2010, *Jatropha: From global hype to local opportunity. Journal of Arid Environments.* 2010. vol. 74, p. 164–165. DOI 10.1016/j.jaridenv.2009.08.010.
- Airbus 2007** AIRBUS, 2007, *Flying by Nature: Global Market Forecast 2007–2026.* . 2007.
- Alexander 2004** ALEXANDER, George and EREN, Esra, 2004, An Assessment of Methane Hydrate Recovery and Processing at Hydrate Ridge. *Energy.* 2004.
- Bellmann 2007** BELLMAN, David K., 2007, *Coal to liquids and gas.* . 2007. vol. c, p. 56.
- Bionas 2011** BIONAS, 2011, No Title. [online]. 2011. [Accessed 2014-10-10]. Available from: <http://ghabainternational.com/bionasghaba/jatropha.html>
- Blakey 2011** BLAKEY, Simon, RYE, Lucas and WILSON, Christopher Willam, 2011, Aviation gas turbine alternative fuels: A review. *Proceedings of the Combustion Institute* [online]. 2011. vol. 33, no. 2, p. 2863–2885. DOI 10.1016/j.proci.2010.09.011. Available from: <http://dx.doi.org/10.1016/j.proci.2010.09.011>
- Campbell 2006** CAMPBELL C.J, 2006, No Title. [online]. 2006. [Accessed 2014-08-12]. Available from: <http://aspo-deutschland.blogspot.de/p/peak-oil.html>
- Daggett 2006** DAGGETT, D., HADALLER, O., HENDRICKS, R. and WALTHER, R., 2006, *Alternative Fuels and Their Potential Impact on Aviation* October 2006. *Nasa/Tm.* 2006. no. October.
- Dekel oil 2014** DEKEL OIL, 2014, No Title. [online]. 2014. [Accessed 2014-09-25]. Available from: <http://www.dekeloil.com/home/page.php?pID=54&ppID=3>

- DLR 2014** DLR, 2014, No Title. [online]. 2014. [Accessed 2014-11-10]. Available from: http://www.dlr.de/dlr/desktopdefault.aspx/tabid-10081/151_read-10119/#/gallery/14479
- DRY 1996** DRY, Mark E., 1996, Practical and theoretical aspects of the catalytic Fischer-Tropsch process. *Applied Catalysis A: General*. 1996. vol. 138, p. 319–344. DOI 10.1016/0926-860X(95)00306-1.
- Furler 2012** FURLER, Philipp, SCHEFFE, Jonathan, GORBAR, Michal, MOES, Louis, VOGT, Ulrich and STEINFELD, Aldo, 2012, Solar thermochemical CO₂ splitting utilizing a reticulated porous ceria redox system. *Energy and Fuels*. 2012. vol. 26, p. 7051–7059. DOI 10.1021/ef3013757.
- Furler 2014** FURLER, Philipp, SCHEFFE, Jonathan, MARXER, Daniel, GORBAR, Michal, BONK, Alexander, VOGT, Ulrich and STEINFELD, Aldo, 2014, Thermochemical CO₂ splitting via redox cycling of ceria reticulated foam structures with dual-scale porosities. *Physical chemistry chemical physics : PCCP* [online]. 2014. vol. 16, p. 10503–11. DOI 10.1039/c4cp01172d. Available from: <http://www.ncbi.nlm.nih.gov/pubmed/24736455>
- Gehrer 2014** GEHRER, M., SEYFRIED, H. and STAUDACHER, S., [no date], LIFE CYCLE ASSESSMENT OF BTL AS COMPARED TO HVO PATHS IN ALTERNATIVE AVIATION FUEL PRODUCTION.
- GMI 2010** GLOBAL METHANE INITIATIVE, 2010, Global Methane Emissions and Mitigation Opportunities lobal Methane Emissions. . 2010. vol. 2020, p. 1–4.
- GMF 2007** GMF, 2007, 2007-2026 Global Market Forecast Air transport has a role in most people life 2007.
- Greg 2006** GREG HEMIGHAUS, TRACY BOVAL, JOHN BACHA, Fred Barnes, 2006, Aviation Fuels Technical Review Table of Contents. 2006. USA.
- GÜBITZ 1999** GÜBITZ, G.M., MITTELBACH, M. and TRABI, M., 1999, Exploitation of the tropical oil seed plant *Jatropha curcas* L. *Bioresource Technology* [online]. 1999. vol. 67, no. 1, p. 73–82. DOI 10.1016/S0960-8524(99)00069-3. Available from: <http://www.sciencedirect.com/science/article/pii/S0960852499000693>

- Gupta 2010** GUPTA, K.K., REHMAN, a and SARVIYA, R.M., 2010, Evaluation of Soya Bio-Diesel as a Gas Turbine Fuel. *Iranica Journal of Energy and Environment (IJEE)* [online]. 2010. vol. 1, no. 3, p. 205–210. Available from: <http://www.doaj.org/doaj?func=openurl&issn=20792115&date=2010&volume=1&issue=3&spage=205&genre=article>
- Han 2013** HAN, Jeongwoo, ELGOWAINY, Amgad, CAI, Hao and WANG, Michael Q., 2013, Life-cycle analysis of bio-based aviation fuels. *Bioresource Technology* [online]. 2013. vol. 150, p. 447–456. DOI 10.1016/j.biortech.2013.07.153. Available from: <http://dx.doi.org/10.1016/j.biortech.2013.07.153>
- Handler 2014** HANDLER, Robert M., SHONNARD, David R., KALNES, Tom N. and LUPTON, F. Stephen, 2014, Life cycle assessment of algal biofuels: Influence of feedstock cultivation systems and conversion platforms. *Algal Research* [online]. 2014. vol. 4, p. 105–115. DOI 10.1016/j.algal.2013.12.001. Available from: <http://dx.doi.org/10.1016/j.algal.2013.12.001>
- Howarth 2011** HOWARTH, Robert W., SANTORO, Renee and INGRAFFEA, Anthony, 2011, Methane and the greenhouse-gas footprint of natural gas from shale formations. *Climatic Change*. 2011. vol. 106, p. 679–690. DOI 10.1007/s10584-011-0061-5.
- IATA 2013** IATA, 2013, *IATA 2013 Report on Alternative Fuels*. ISBN 9789292522599.
- ICAO 2013** ICAO, 2013, No Title. [online]. 2013. [Accessed 2014-08-12]. Available from: <http://www.icao.int/Newsroom/Pages/2013-ICAO-AIR-TRANSPORT-RESULTS-CONFIRM-ROBUST-PASSENGER-DEMAND,-SLUGGISH-CARGO-MARKET.aspx>
- Kim 2009** KIM, Yong Heon, JUN, Ki W., JOO, Hyunku, HAN, Chonghun and SONG, In Kyu, 2009, A simulation study on gas-to-liquid (natural gas to Fischer-Tropsch synthetic fuel) process optimization. *Chemical Engineering Journal*. 2009. vol. 155, p. 427–432. DOI 10.1016/j.cej.2009.08.018.
- KTH 2014** KTH, 2014, No Title. [online]. 2014. [Accessed 2014-12-10]. Available from:

http://www.energy.kth.se/compedu/webcompedu/WebHelp/S4_Combustion/B1_Combustion_Basics/C1_Introduction_to_Combustion/ID35_files/Lower_calorific_value.htm

- Li 2014** LI, Xue and MUPONDWA, Edmund, 2014, Life cycle assessment of camelina oil derived biodiesel and jet fuel in the Canadian Prairies. *Science of the Total Environment* [online]. 2014. vol. 481, p. 17–26. DOI 10.1016/j.scitotenv.2014.02.003. Available from: <http://dx.doi.org/10.1016/j.scitotenv.2014.02.003>
- Lonero 2008** LONERO, Andrew, 2008, How are Methane Hydrates Formed , Preserved , and Released ? . 2008.
- Luftfahrt 2014** LUFTFAHRT, Bauhaus, 2014, No Title. [online]. 2014. [Accessed 2014-11-10]. Available from: <http://www.solar-jet.aero/>
- Marsh 2008** MARSH, George, 2008, No Title. [online]. 2008. [Accessed 2014-09-20]. Available from: <http://www.renewableenergyfocus.com/view/3320/biofuel-aviation-alternative/>
- Milledge 2014** MILLEDGE, John, SMITH, Benjamin, DYER, Philip and HARVEY, Patricia, 2014, Macroalgae-Derived Biofuel: A Review of Methods of Energy Extraction from Seaweed Biomass. *Energies* [online]. 2014. vol. 7, p. 7194–7222. DOI 10.3390/en7117194. Available from: <http://www.mdpi.com/1996-1073/7/11/7194/>
- Molina grima 1999** MOLINA GRIMA, E., ACIÉN FERNÁNDEZ, F.G., CAMACHO, F. García and CHISTI, Yusuf, 1999, Photobioreactors: light regime, mass transfer, and scaleup. *Journal of Biotechnology*. 1999. vol. 70, p. 231–247.
- Molina grima 2003** MOLINA GRIMA, E., BELARBI, E.H., ACIÉN FERNÁNDEZ, F.G., ROBLES MEDINA, a. and CHISTI, Yusuf, 2003, Recovery of microalgal biomass and metabolites: Process options and economics. *Biotechnology Advances*. 2003. vol. 20, p. 491–515. DOI 10.1016/S0734-9750(02)00050-2.
- Moses 2008** MOSES, C.a, 2008, Comparative evaluation of semi-synthetic jet fuels. *Contract*. 2008. vol. 33415, no. September, p. 2299.
- Mustaq 2012** MUSHTAQ, Waqas, 2012, Methane Hydrates as Potential Energy Resource. . 2012. no. November.

- NOAA 2001** NOAA, 2001, No Title. [online]. 2001. [Accessed 2014-12-10]. Available from: http://oceanexplorer.noaa.gov/explorations/deepeast01/background/fire/media/carb_dist.html
- NREL 1998** NREL, 1998, A look back at the U. S. Department of Energy's aquatic species program: biodiesel from algae. *Report* [online]. 1998. vol. 328, p. 291 p. DOI 10.2172/15003040. Available from: http://www.biodiesel.pl/uploads/media/A_Look_Back_at_the_U.S._Department_of_Energy_s_Aquatic_Species_Program_Biodiesel_from_Algae_July_1998.pdf
- Prins 2005** PRINS, Mark J., PTASINSKI, Krzysztof J. and JANSSEN, F.J.J.G., 2005, Exergetic optimisation of a production process of Fischer-Tropsch fuels from biomass. *Fuel Processing Technology*. 2005. vol. 86, p. 375–389. DOI 10.1016/j.fuproc.2004.05.008.
- Scholz 1999** SCHOLZ, Dieter, *Lecture Notes, Hamburg University of Applied Sciences, 1999*.
- Ronald 2004** DE DEUGD, Ronald M., 2004, *Fischer-Tropsch Synthesis Revisited; Efficiency and Selectivity Benefits from Imposing Temporal and/or Spatial Structure in the Reactor*. ISBN 9090176470.
- Ruppel 2011** RUPPEL, Carolyn, 2011, Methane Hydrates and the Future of Natural Gas. *MITEI Natural gas Report, Supplementary Paper on Methane Hydrates 4*. 2011. p. 1–25.
- Rye 2010** RYE, L., BLAKEY, S. and WILSON, C.W., 2010, Sustainability of supply or the planet: a review of potential drop-in alternative aviation fuels. *Energy & Environmental Science*. 2010. vol. 3, p. 17. DOI 10.1039/b918197k.
- Shafiee 2009** SHAFIEE, Shahriar and TOPAL, Erkan, 2009, When will fossil fuel reserves be diminished? *Energy Policy*. 2009. vol. 37, no. 1, p. 181–189. DOI 10.1016/j.enpol.2008.08.016.
- Smith 2011** SMITH, Christopher a., DEHORATIIS JR., Guido, BOSWELL, Ray M., DUDA, John R., YOST, Albert B. and LONG, Roy, 2011, Energy Resource Potential of Methane Hydrate. An introduction to the science and energy potential of a unique resource. [online]. 2011. p. 24. Available from: www.netl.doe.gov

- Soybean 2014** SOYBEAN, 2014, No Title. [online]. 2014. [Accessed 2014-10-05]. Available from: <http://cropwatch.unl.edu/bioenergy/soybeans>
- Stratton 2010** STRATTON, Russell W., WONG, Hsin Min and HILEMAN, James I., 2010, Life cycle gas emissions from alternative jet fuels. . 2010. vol. 571, p. 153.
- Stratton 2010** STRATTON, Russell William, 2010, Life Cycle Assessment of Greenhouse Gas Emissions and by. . 2010.
- Sudiro 2009** SUDIRO, Maria and BERTUCCO, Alberto, 2009, Production of synthetic gasoline and diesel fuel by alternative processes using natural gas and coal: Process simulation and optimization. *Energy* [online]. 2009. vol. 34, no. 12, p. 2206–2214. DOI 10.1016/j.energy.2008.12.009. Available from: <http://dx.doi.org/10.1016/j.energy.2008.12.009>
- Sunfire 2015** SUNFIRE, 2015, POWER-TO-LIQUIDS. [online]. 2015. [Accessed 2015-03-02]. Available from: <http://www.sunfire.de/en/kreislauf/power-to-liquids>
- USDA 2010** USDA, 2010, No Title. [online]. 2010. [Accessed 2014-10-12]. Available from: http://www.esru.strath.ac.uk/EandE/Web_sites/02-03/biofuels/what_biodiesel.htm
- USDA 2012** USDA, 2012, No Title. [online]. 2012. [Accessed 2014-10-12]. Available from: <http://www.ers.usda.gov/topics/crops/soybeans-oil-crops/market-outlook.aspx>
- Varone 2015** VARONE, Alberto and FERRARI, Michele, 2015, Power to liquid and power to gas: An option for the German Energiewende. *Renewable and Sustainable Energy Reviews* [online]. 2015. vol. 45, p. 207–218. DOI 10.1016/j.rser.2015.01.049. Available from: <http://linkinghub.elsevier.com/retrieve/pii/S1364032115000593>
- Wang 2004** WANG, Michael, LEE, Hanjie and MOLBURG, John, 2004, LCA Case Studies Allocation of Energy Use in Petroleum Refineries to Petroleum Products Implications for Life-Cycle Energy Use and Emission Inventory of Petroleum Transportation Fuels. *International Journal of Life Cycle Assessment*. 2004. vol. 9, no. 1, p. 34–44. DOI 10.1065/Ica2003.07.129.

- Wong 2008** WONG, Hsin Min, 2008, Life-cycle assessment of greenhouse gas emissions from alternative jet fuels. . 2008. no. September.
- WOR 2014** WORLD OCEANIC REVIEW, 2014, No Title. [online]. 2014. [Accessed 2014-12-12]. Available from: <http://worldoceanreview.com/en/wor-3-overview/methane-hydrate/extraction/>
- Yusuf 2007** YUSUF, Chisti, 2007, Biodiesel from microalgae. *Biotechnology Advances* [online]. 2007. vol. 25, p. 294–306. DOI 10.1016/j.biotechadv.2007.02.001. Available from: <http://www.sciencedirect.com/science/article/pii/S0734975007000262>