

AIRCRAFT DESIGN AND SYSTEMS GROUP (AERO)

Aviation and the Climate – An Overview

Dieter Scholz

Hamburg University of Applied Sciences

Hamburg Aerospace Lecture Series (AeroLectures)

DGLR, RAeS, VDI, ZAL, HAW Hamburg

Online, 27 January 2022

<https://doi.org/10.5281/zenodo.xxxxxxx>

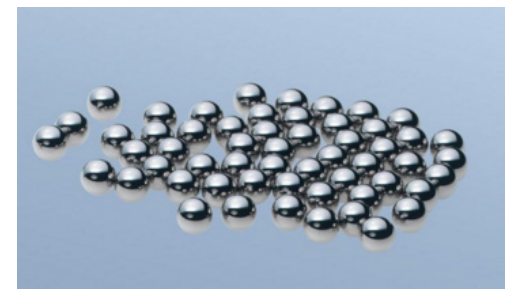
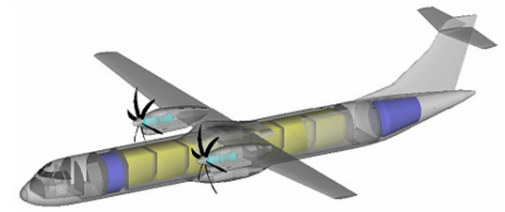
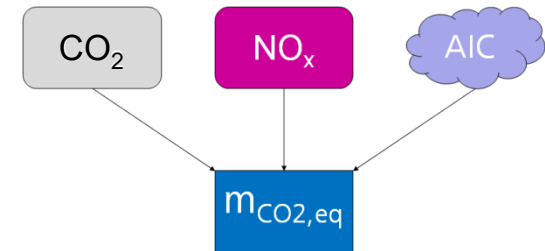

RAeS Hamburg in cooperation with the DGLR, VDI, ZAL & HAW invites you to a lecture

Aviation and the Climate – An Overview

Prof. Dr.-Ing. Dieter Scholz, MSME, HAW Hamburg

Date: Thursday, 27 January 2022, 18:00 CET

Online: <https://purl.org/ProfScholz/zoom/2022-01-27>



Introduction to Emissions from Aviation

Are emissions from aviation relevant?
 What climate goals does the EU have for aviation?
 LH2 and SAF, the new energy carriers in aviation
 From Energy to Emission Comparison
 What is better for the environment - plane or train?

Sustainable Aviation Fuel (SAF) in Germany

History of SAF in Germany. SAF from Atmosfair
 SAF Production. Virtual SAF. The SAF-Seal

Kerosene and Hydrogen Emissions

Primary Energy for SAF and Hydrogen
 Altitude-Dependent Equivalent CO2 Mass
 Aviation-Induced Cloudiness (AIC): Contrail Cirrus & Persistent Contrails
 Schmidt-Appleman Criterion for Contrail Formation
 Heating Value Q, Emission Index EI, and Slope G
 Hydrogen: Less NOx in Lean Combustion
 The "Ice Sphere Model". Estimating the Emission
 Characteristics of Kerosene and Hydrogen

Mitigating Aviation Emissions at Altitude

Operational Measures to Avoid Contrails
 Flying Lower. Redirecting Flights
 Regulatory Policies for Aviation Emissions

Action?

Ecolabels for Aircraft
 What can we actually do ourselves?

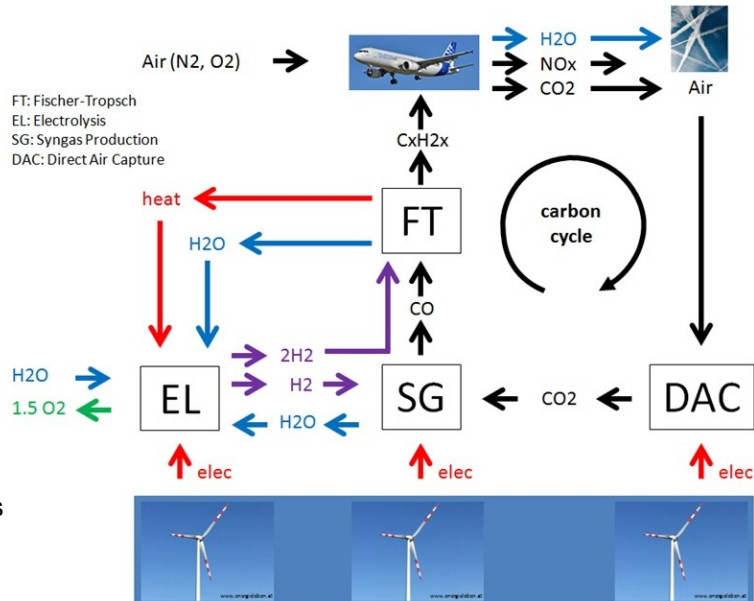

The **carbon cycle**. CO2 that is released into the atmosphere has to be captured from the air. In the long run CO2 from e.g. a coal power plant cannot be used, because there will be no such plants left. The carbon cycle by itself does not make aviation climate neutral, because NOx and H2O are still released. How much more CO2 would need to be captured and stored underground to make **synthetic fuel a truly sustainable aviation fuel (SAF)?**



Aviation and the Climate – An Overview

Abstract

Purpose –

Methodology –

Findings –

Practical implications –

Social implications –

Originality/value –

update pending



Hamburg Aerospace
Lecture Series

DGLR
HAW Hamburg RAeS
VDI ZAL



Hamburg Aerospace Lecture Series
Hamburger Luft- und Raumfahrtvorträge

 <http://www.AeroLectures.de>

Contents

- **Emissions from Aviation**
- **Sustainable Aviation Fuel (SAF)**
- **Kerosene and Hydrogen Emissions**
- **Mitigating Aviation Emissions**
- **Summary**

This Lecture Combines Earlier Contributions and Adds to Them

- **Emissions from Aviation**

from: "*Umweltschutz in der Luftfahrt*" (Report)

<https://purl.org/aero/RR2021-07-03> (PDF, German)

<https://purl.org/aero/PR2021-07-03> (HTML, German and automatic English translation)

from: "Passenger Aircraft Design towards Lower Emissions with SAF, LH2, and Batteries (Pros & Cons)"

<https://doi.org/10.5281/zenodo.5904292>

- **Sustainable Aviation Fuel (SAF) in Germany**

from: "*CO2-Kompensierer Atmosfair betreibt weltweit erste Anlage zur Produktion von klimaneutralem Kerosin – Eine Analyse*" (Report, unpublished)

- **Kerosene and Hydrogen Emissions**

from: "*Zero Emission – The New Credo in Civil Aviation*", <https://doi.org/10.5281/zenodo.5919013>

from: "Design of Hydrogen Passenger Aircraft", <https://doi.org/10.5281/zenodo.4301103>

- **Mitigating Aviation Emissions**

from: "*Design of Hydrogen Passenger Aircraft*", <https://doi.org/10.5281/zenodo.4301103> and from other sources

Emissions from Aviation

General Observations

Most Important : Clean Drinking Water (not the topic of this lecture)

Current focus: CO2 and energy, but:

1. It is generally not about CO2 and energy, but **about clean drinking water!**
2. It is in aviation in global warming not primarily about CO2 but it is **about Aviation Induced Cloudiness (AIC)**. Aviation has a water problem not a CO2 problem.

Needed: Balanced look with **Life Cycle Assessment**

Everything is connected:

melting ice => global warming
 global warming => melting ice
 fossile energy use => global warming
 global warming => less energy for heating
 energy use for desalination => water
 water usage => energy generation (H2, ...)

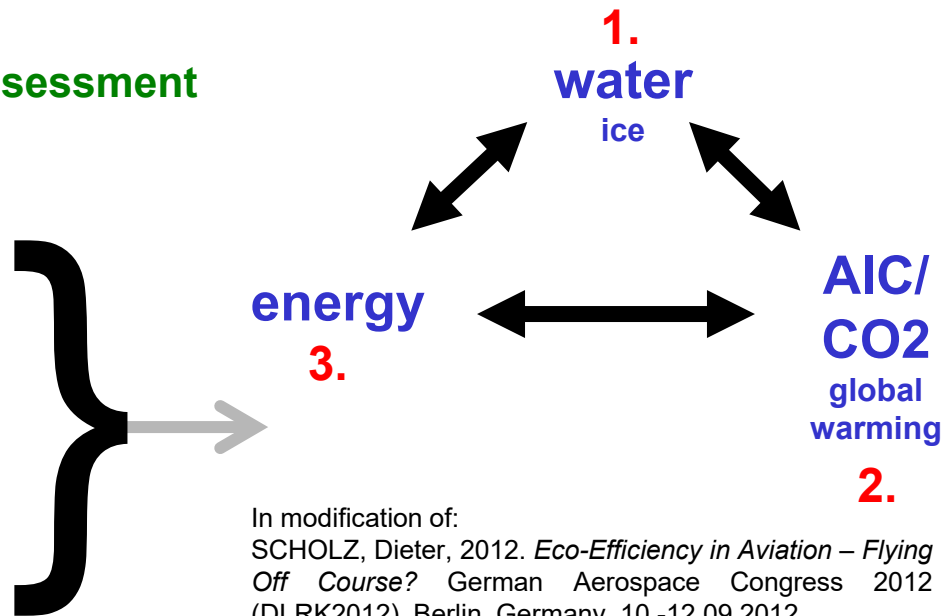

In modification of:
 SCHOLZ, Dieter, 2012. *Eco-Efficiency in Aviation – Flying Off Course?* German Aerospace Congress 2012 (DLRK2012), Berlin, Germany, 10.-12.09.2012.
 Available from: <https://doi.org/10.5281/zenodo.4067014>

Most Important : Clean Drinking Water (not the topic of this lecture)

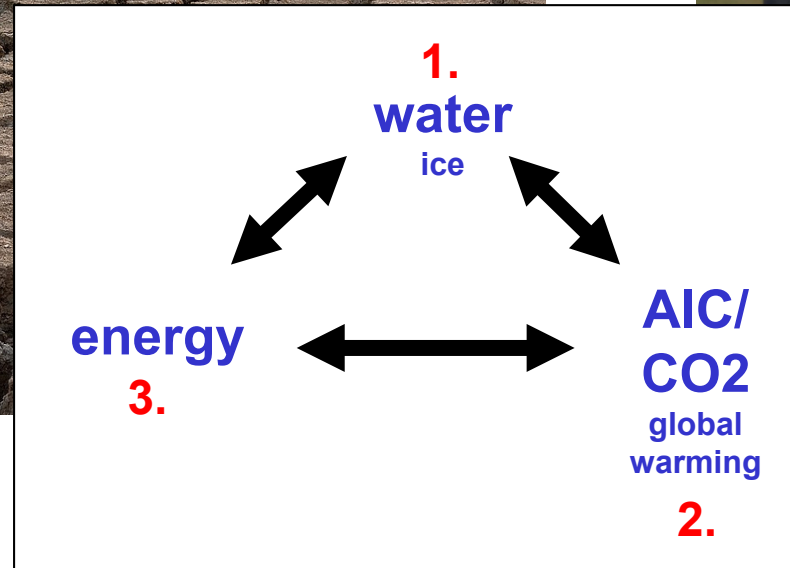
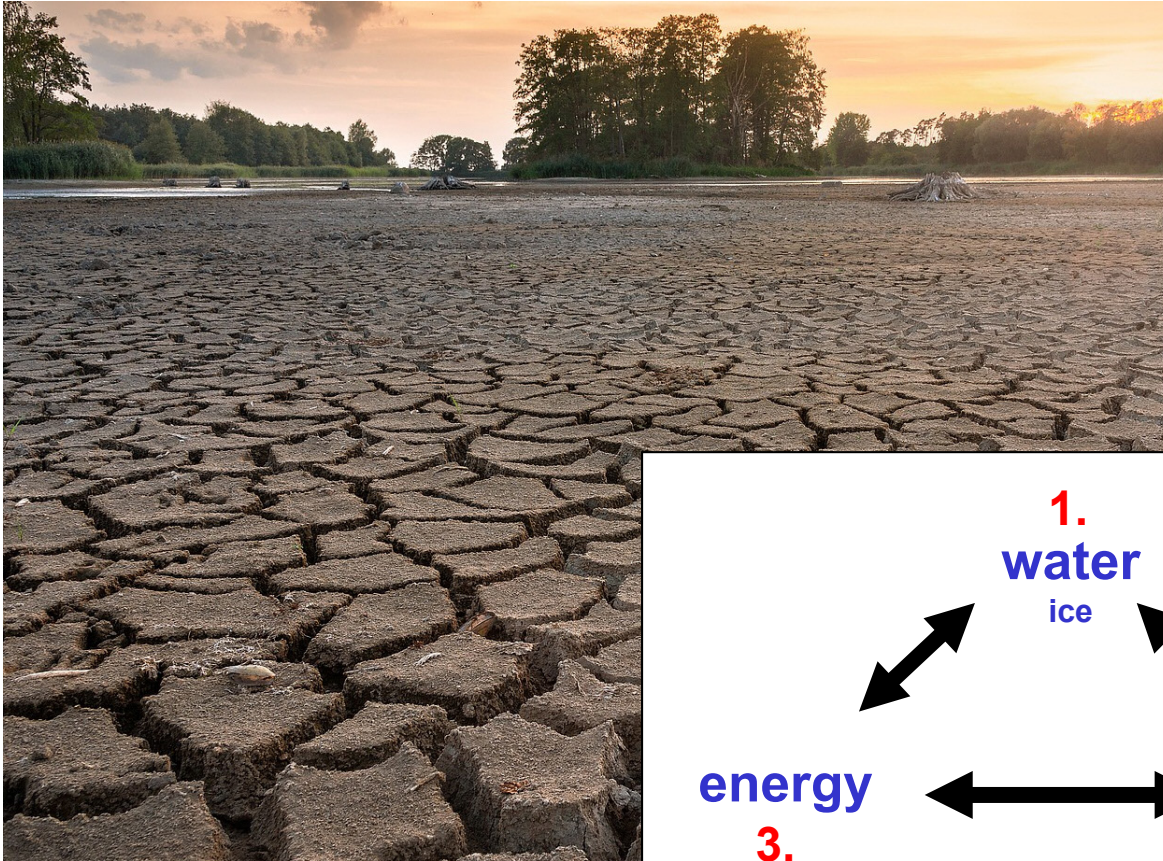

Are Emissions from Aviation Relevant?

Anteil der Treibhausgasemissionen
je Verkehrsträger (2017)

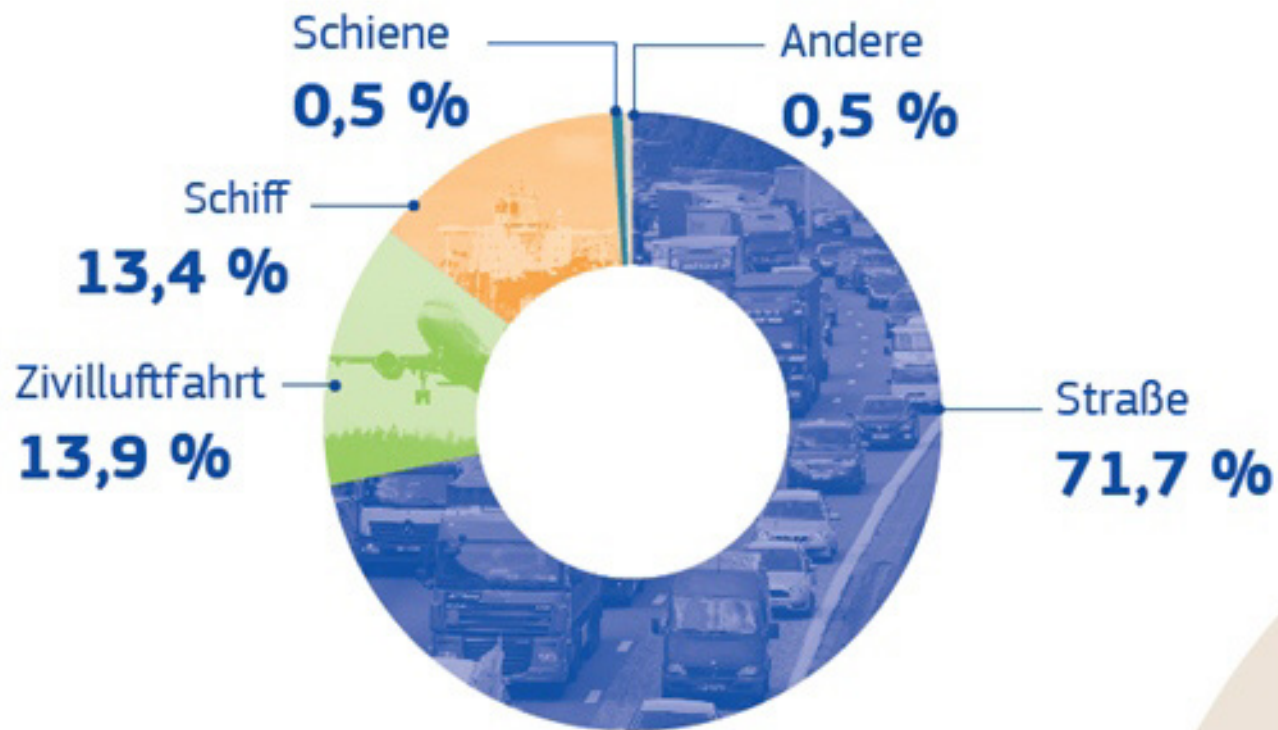

What are the Climate Targets for Aviation?

Aviation Promises and Visions for 2020

The year **2020** was pivotal related to environmental goals:

- **ACARE**: European Aeronautics – A Vision for **2020**:
"A 50% cut in fuel consumption in the new aircraft of 2020" compared to 2000
- **IATA**: Carbon-neutral growth from **2020**
- **ATAG**: Carbon-neutral growth from **2020**
- **ICAO**: CORSIA: "the basis for carbon neutral growth from **2020**"
- **Goals Today**: **Zero Emission** (<https://www.destination2050.eu>)

History of "Zero Emissions":

IATA 2007: First in Proclaiming "Zero Emissions" (Goals Not Active Anymore)

[Home](#) » [Pressroom](#) » [Press Releases](#) » [IATA Calls for a Zero Emissions Future](#)

No.: 21

Date: 4 June 2007



IATA Calls for a Zero Emissions Future

VANCOUVER - The International Air Transport Association (IATA) issued four challenges to drive the air transport industry towards its vision of zero emissions.

“The environmental track record of the industry is good: over the last four decades we have reduced noise by 75%, eliminated soot and improved fuel efficiency by 70%. And the billions being invested in new aircraft will make our fleet 25% more fuel efficient by 2020. This will limit the growth of our carbon footprint from today’s 2% to 3% in 2050” said Giovanni Bisignani, IATA Director General and CEO.

“But a growing carbon footprint is no longer politically acceptable—for any industry. Climate change will limit our future unless we change our approach from technical to strategic. Air transport must aim to become an industry that does not pollute—zero emissions” said Bisignani.

Archived at: <https://perma.cc/JSR2-JC79>

IATA: CNG from 2020

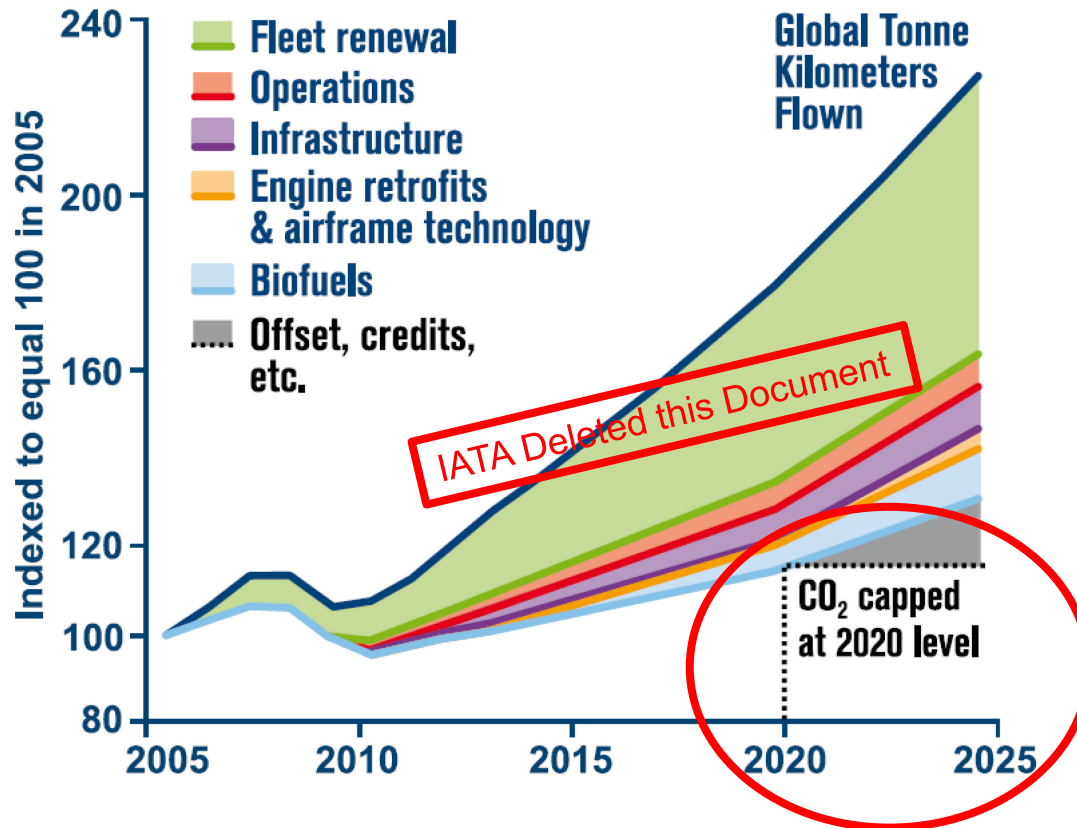

2020 is **arbitrary** to start with CO₂ compensation.

Compensation could have started earlier.

Why not postpone longer?

Did we notice any change with the 2020 CO₂ cap?

IATA (and ATAG) want to achieve zero emission growth from 2020 onwards. This is only possible with CO₂ compensation (carbon **offset schemes**).

Archived at: <https://perma.cc/42HW-ZTKF>

What is the Issue – Fuel Consumption or Emissions?

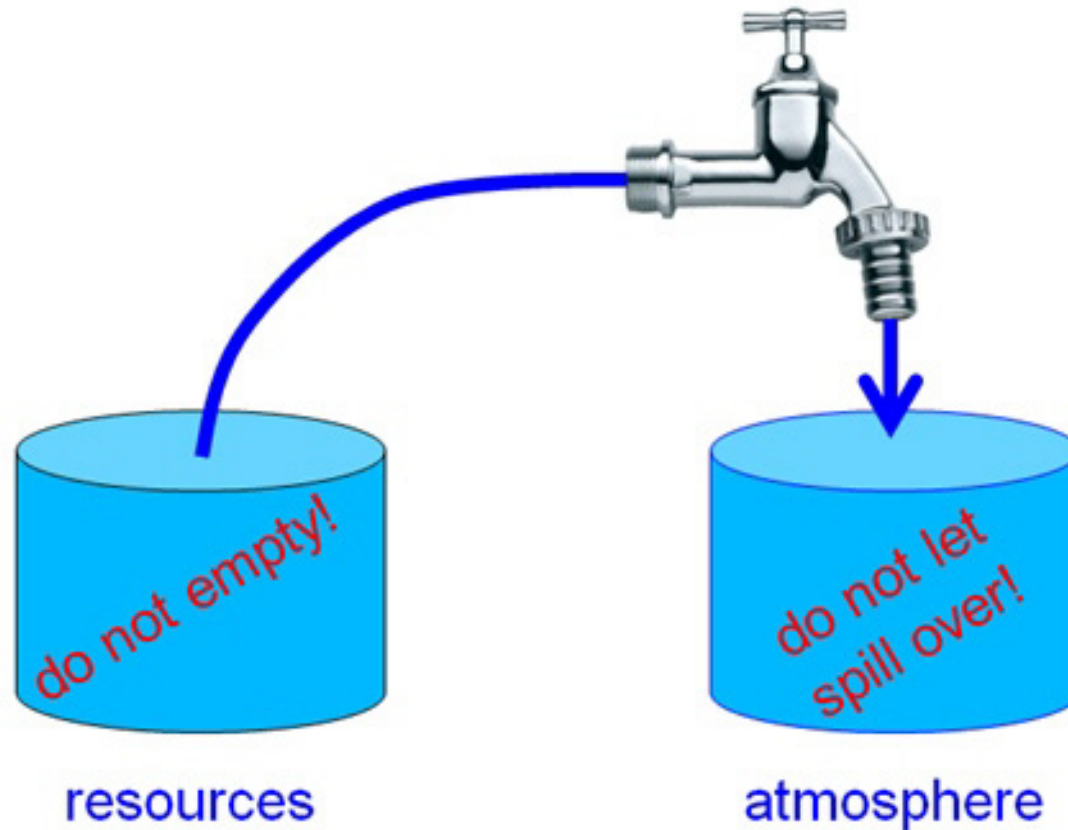

With carbon neutral growth (CNG) the tap is left wide open.

Maybe it is time to close the tap a least a little?

Yes, with "zero emission"!

ICAO: CORSIA: "the basis for carbon neutral growth from 2020"

CORSIA: Carbon Offsetting and Reduction Scheme for International Aviation



Multiple Phases

- 2019-2020: Monitoring for determination of the emissions baseline
- 2021-2023: Pilot phase (voluntary participation of the states)
- 2024-2026: Phase 1 (voluntary participation of the states)
- **2027-2035**: Phase 2 (**mandatory** participation for all countries and their aircraft operators more than 0.5% of global air traffic in 2018, in ensuring that 90% of global air traffic is covered).

To begin the pilot phase alone took 5 years and let CORSIA start in 2021. The statement "the basis for carbon neutral growth from 2020" means in light of the regulations that **carbon-neutral growth may never be achieved** (its only the bases) and that it comes later than 2020 ("from") .

What Climate Goals Does the EU Have for Aviation?

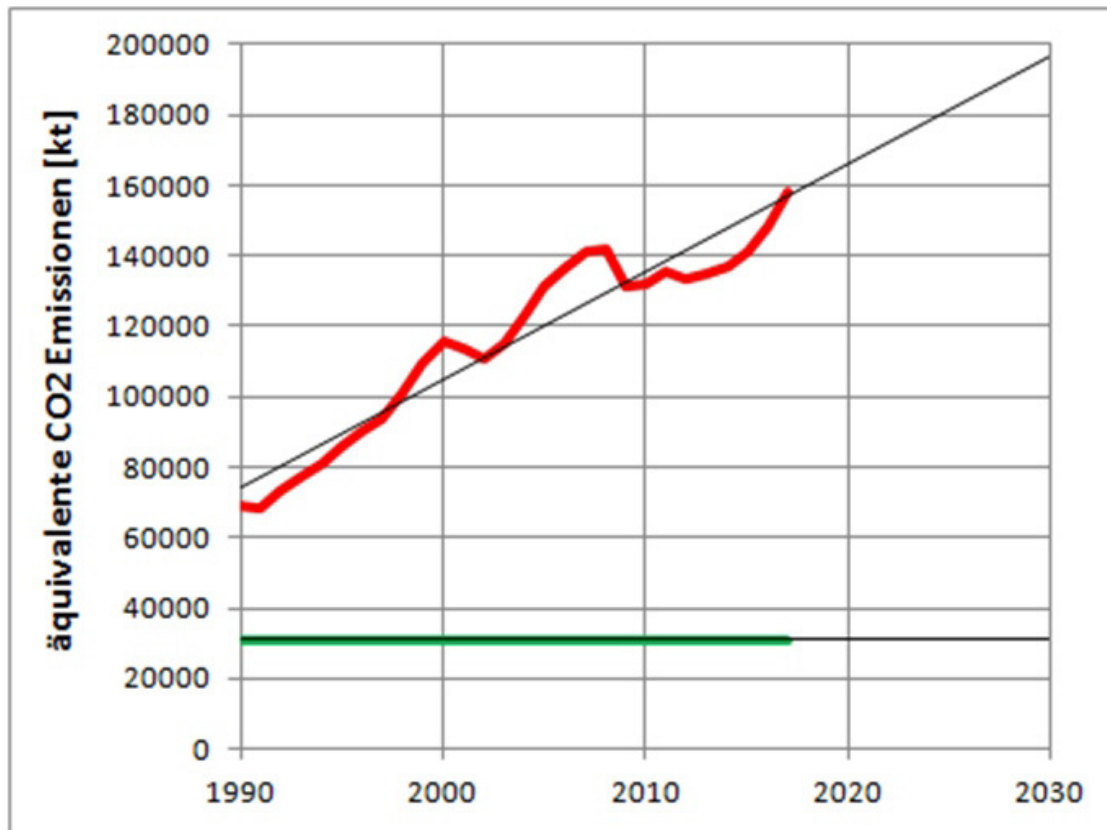

"Fit for 55"

- 1.) 2019: The EU's "**Green Deal**": "no more net greenhouse gas emissions should be released in 2050".
- 2.) 2020: Europe's climate target for 2030 was defined under the motto "**Fit for 55**". This is an interim goal for the Green Deal, greenhouse gas emissions are to be reduced by 55% compared to 1990 – i.e. only 45% of the 1990 value. This value should be reached by 2030.

What Climate Goals Does the EU Have for Aviation?

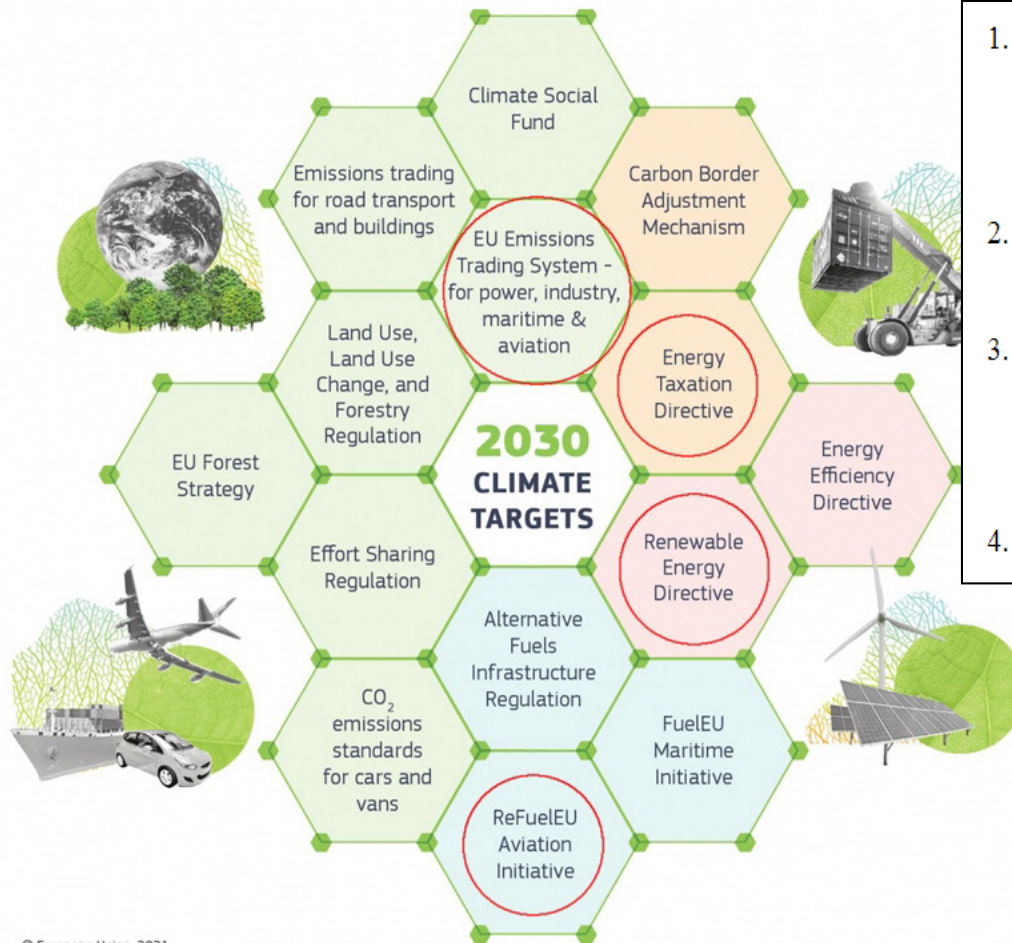

1. The **free emission** certificates for aviation in the EU emissions trading system (EU ETS) **will be phased out** (EU 2021c). For intra-European flights, the allowances are reduced by 4.2% each year. For flights outside the EU, CORSIA (EU 2021d) applies. All European countries will participate voluntarily from 2021 (EU 2021e).
2. A **tax on kerosene** will be gradually introduced from January 1st, 2023 before the final minimum rate of EUR 10.75/GJ is reached after a transitional period of ten years (EU 2021f, EU 2021g).
3. **Fuel suppliers must gradually add sustainable aviation fuel (SAF)** to the turbine fuel offered in the EU (Figure 5), including so-called e-fuels (EU 2021h). See below for details on e-fuels. The European Aviation Safety Agency (EASA) is to monitor and report (EASA 2021).
4. Aircraft must have access to clean electricity at airports (EU 2021b).

"Fit for 55"

What Climate Goals Does the EU Have for Aviation?

"Fit for 55"

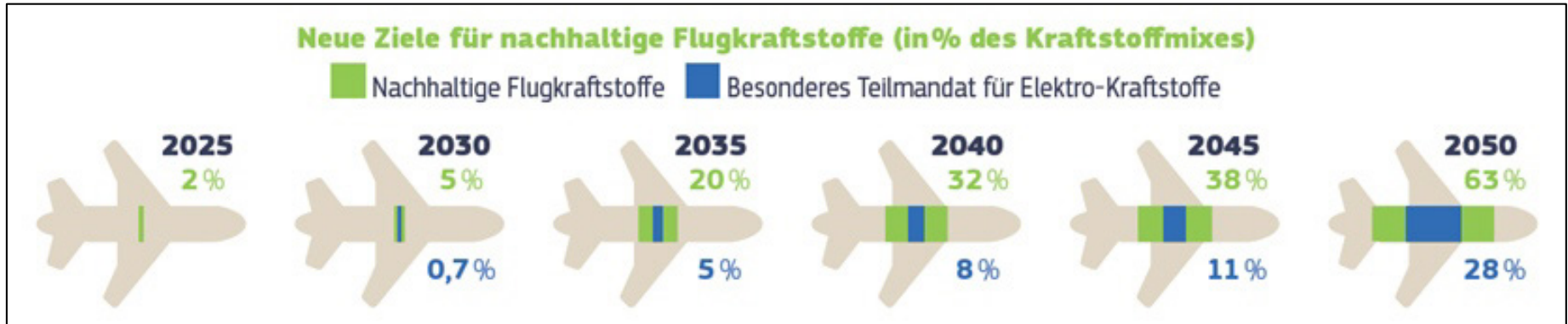

Airlines schmieden Bündnis gegen EU-Luftfahrpläne

Die großen europäischen Airlines, darunter auch die Lufthansa Gruppe, schließen eine Allianz, um Änderungen beim Klimapaket "Fit for 55" durchzusetzen. Grundsätzlich bekennen sich die Airlines zum CO2-Reduktion.



24.01.2022

How Do We Get from Oil to the New Energy Carriers in Aviation?

1.) Aviation should be fueled by **algae** (Reddy 2015).

REDDY, Chris, O'NEIL, Greg, 2015. Jet Fuel from Algae?. Archived at: <https://perma.cc/T5SG-7NFA>

2.) Renewable electricity should be stored in **batteries**.

Passenger aircraft should be battery-electric operated.

3.) **Hybrid-electric** passenger **aircraft** are discussed.

Many possible combinations of conventional and electrical technology.



AIRBUS, 2018. The Future is Electric. Press Release, 2018-07-17. Archived at: <https://perma.cc/V36S-7UVR>

LH2 and E-Fuel



<https://doi.org/10.2843/471510>
 Archived at: <https://perma.cc/BJJ6-5L74>

AIRBUS and many others

Emissions

Average values	CO ₂	NO _x	Water vapor	Contrails	Total
Kerosene	100%	100%	10%	100%	310%
Synfuel	0%	100%	10%	75%	185%
H₂ turbine	0%	35%	25%	60%	120% ≠ 0%
H ₂ fuel cell	0%	0%	25%	30%	55%

Energy / Primary Energy

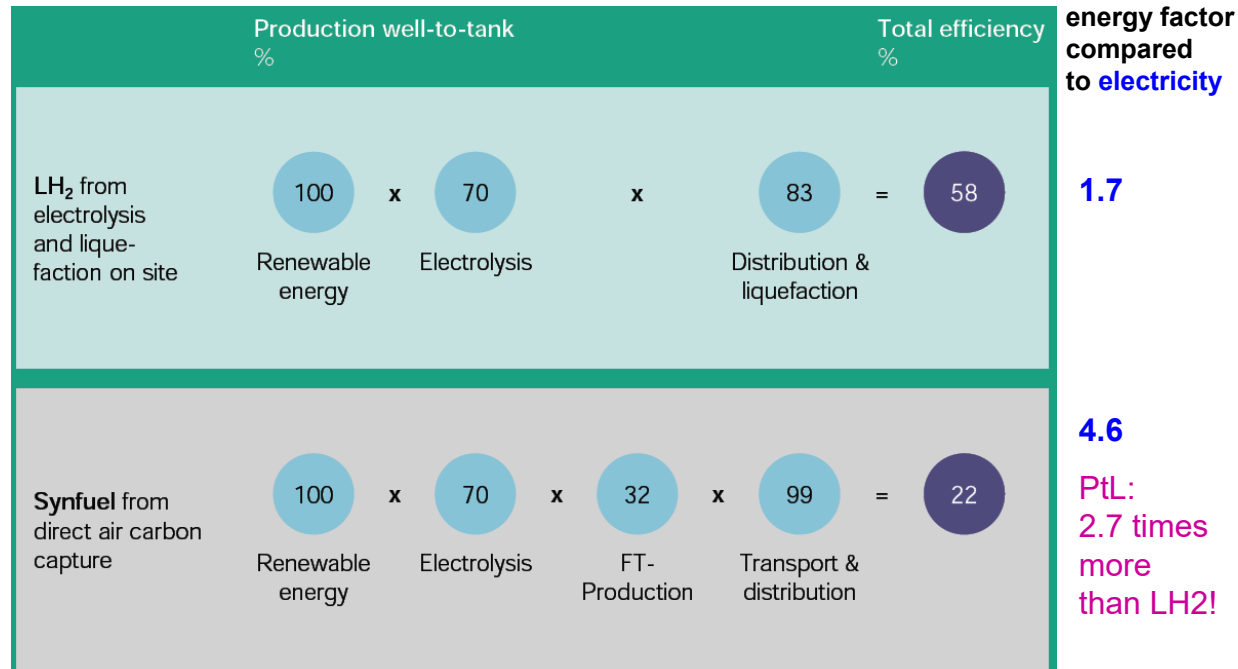

Refueling an A350 Once per Day Can Be Done with 52 Big Wind Power Plants (4.6 MW Each)

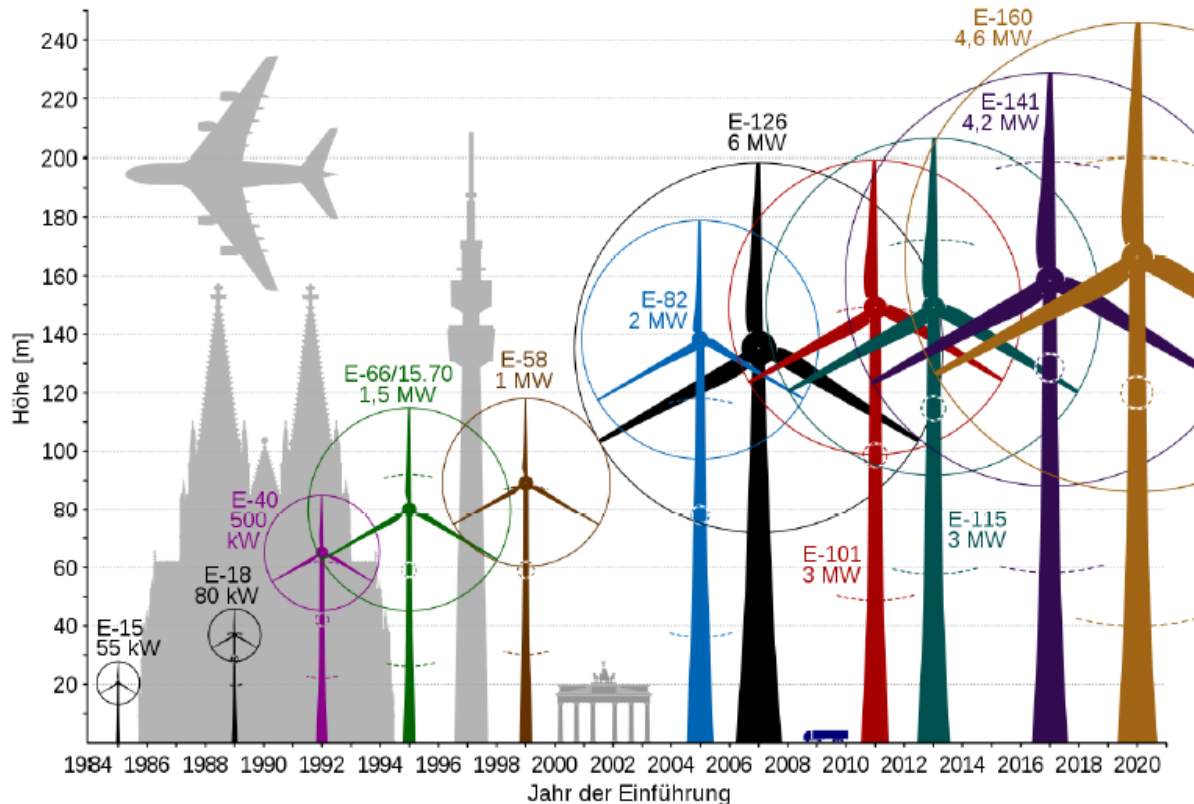

Airbus A350-900:

Kraftstoffkapazität: 138.000 L

1x Volltanken pro Tag
entspricht

52x E-160 4,6 MW

(Annahmen: CF=50%, $\eta_{PIL} = 0.45\%$)

Comparison with Solar Power

update pending

- 1.) From the panels below not even one return flight over the Atlantic per year one person.
- 2.) From panels on 1 ha = 10000 m² energy equivalent to 93 t fuel per year (fueling one A321 with e-fuel, fuel production efficiency 25%).
- 3.) From panels on 100 ha (a strip 300 m wide along the 3,5 km runway) Airport 18 h open, take-off each 6 min. 65700 movements p.a., 0.15% fueled by airport.

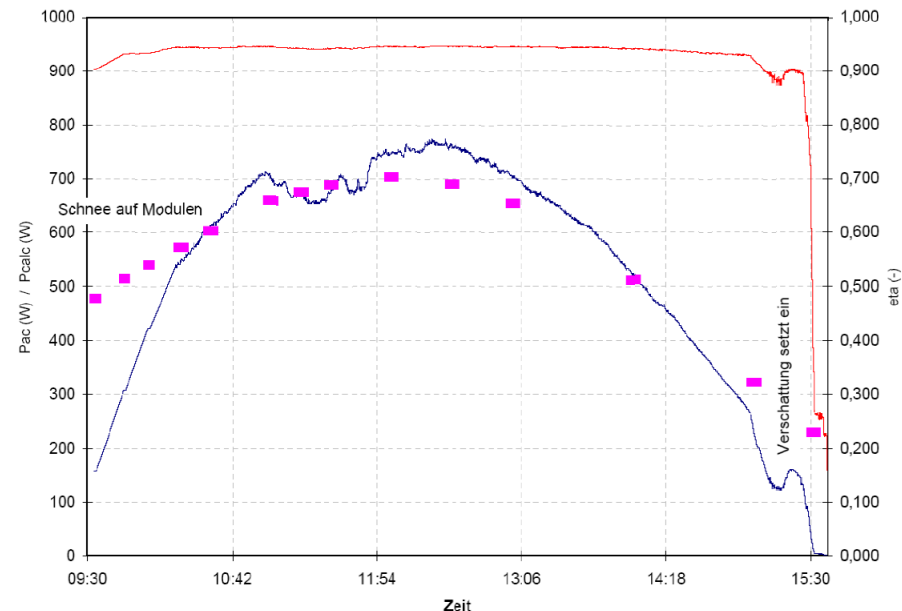

EU-Study, May 2020: Aviation's Energy Demand – Too Much

The full global demand for LH₂ in aviation would require as much as 500 or 1,500 gigawatts of renewable energy capacity, depending on the scenario assumed, or about 20 or 60 percent of the total capacity of renewable energy available today.³⁸ Scaling up to this capacity would obviously raise significant planning challenges. That being said, if an energy-equivalent amount of synfuel from direct air capture were produced, it would require about three times the amount of renewable energy and one and a half times the amount of electrolysis. This is a significant drawback for synfuel, as the global energy system will already be challenged to scale up enough renewable energy to make the overall energy transition a success (as illustrated in the box on the next page.)

Footnote 38: Total generation capacity of renewable energy: 2351 GW (2018)

Globally, total renewable energy generation capacity reached 2,351 GW at the end of last year – about a third of total installed electricity capacity. Hydropower accounts for the largest share with an installed capacity of 1,172 GW – about half of the total. Wind and solar energy account for most of the remainder, with capacities of 564 GW and 480 GW, respectively. Other renewables included 121 GW of bioenergy, 13 GW of geothermal energy and 500 MW of marine energy (tide, wave and ocean energy).

<https://www.hydroreview.com/2019/04/03/irena-reports-renewable-energy-now-accounts-for-a-third-of-global-power-capacity>
 Archived at: <https://perma.cc/YLY4-CG2R>

Aviation's energy demand today is too high: Minimum all wind or solar energy available today!

First we need to reduce the amount of air travel.

Then we may have a chance to power aviation with renewable energy.

Biggest Emission Reduction in Aviation History Thanks to the Corona Pandemic



Ikreis, CC BY-SA, <https://bit.ly/2Jn11T0>



Traffic reduction is
more efficient than
technology



<https://stay-grounded.org>

It's about more than just CO2

Aviation must reduce its total impact on climate

Power to Liquid (PTL), E-Fuel, Sustainable Aviation Fuel (SAF)

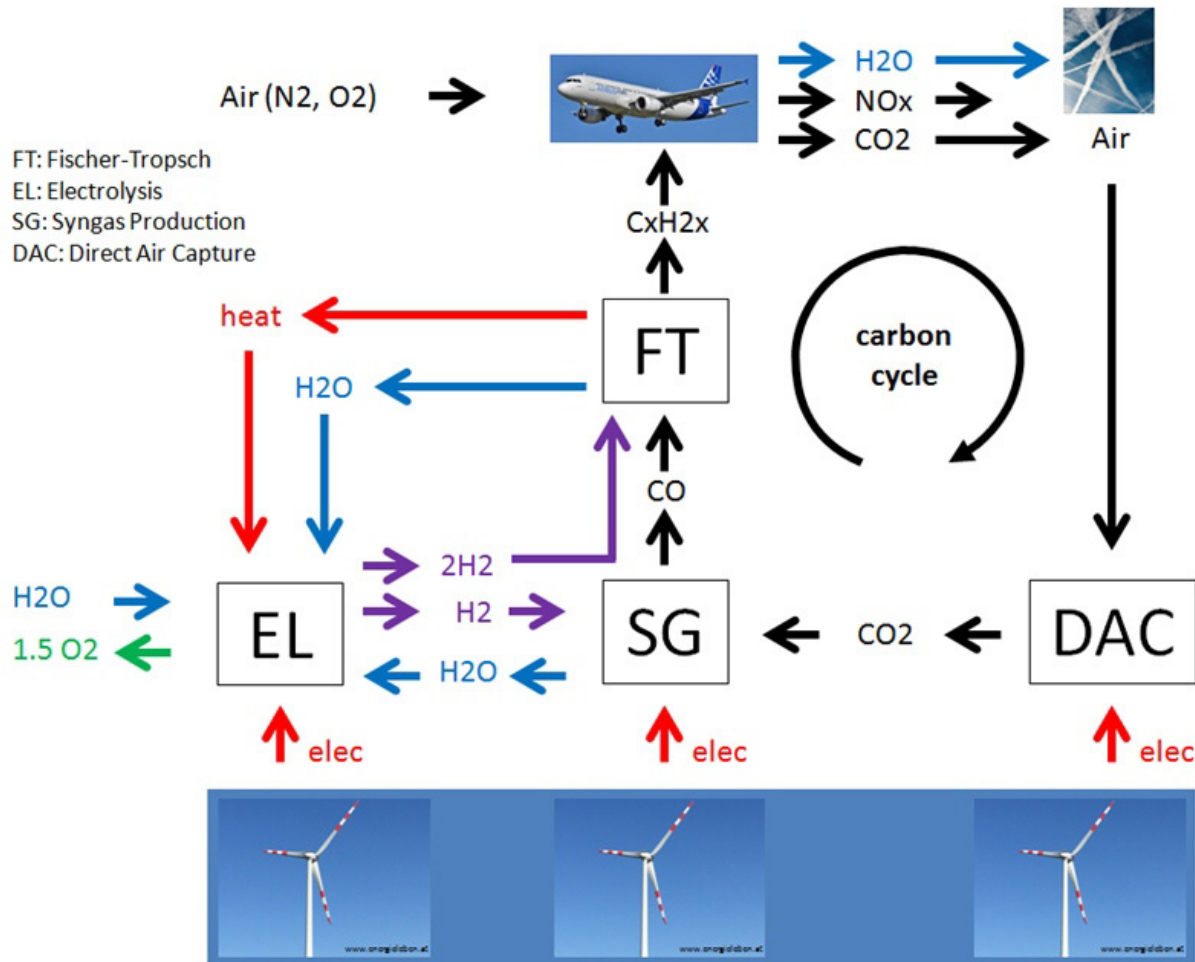

The Carbon Cycle

How Much More CO2 Would Need to Be Captured?

Hamburg Aerospace Lecture Series
 Hamburger Luft- und Raumfahrtvorträge
 RAeS Hamburg in cooperation with the DGLR, VDI, ZAL & HAW invites you to a lecture

Aviation and the Climate – An Overview

Prof. Dr.-Ing. **Dieter Scholz**, MSME, HAW Hamburg
 Date: Thursday, 27 January 2022, 18:00 CET
 Online: <https://purl.org/ProfScholz/zoom/2022-01-27>

Introduction to Emissions from Aviation
 Are emissions from aviation relevant?
 What climate goals does the EU have for aviation?
 LH2 and SAF, the new energy carriers in aviation
 From Energy to Emission Comparison
 What is better for the environment - plane or train?

Sustainable Aviation Fuel (SAF) in Germany
 History of SAF in Germany, SAF from Atmosfair
 SAF Production, Virtual SAF, The SAF-Seal

Kerosene and Hydrogen Emissions
 Primary Energy for SAF and Hydrogen
 Altitude-Dependent Equivalent CO2 Mass
 Aviation-Induced Cloudiness (AIC): Contrail Cirrus & Persistent Contrails
 Schmidt-Appelman Criterion for Contrail Formation
 Heating Value Q_h, Emission Index EI, and Slope G
 Hydrogen: Less NOx in Lean Combustion
 The "Ice Sphere Model", Estimating the Emission Characteristics of Kerosene and Hydrogen

Mitigating Aviation Emissions at Altitude
 Operational Measures to Avoid Contrails
 Flying Lower, Redirecting Flights
 Regulatory Policies for Aviation Emissions

Action?
 EcoLabels for Aircraft
 What can we actually do ourselves?

The carbon cycle. CO₂ that is released into the atmosphere has to be captured from the air. In the long run CO₂ from e.g. a coal power plant cannot be used, because there will be no such plants left. The carbon cycle by itself does not make aviation climate neutral, because NO_x and H₂O are still released. How much more CO₂ would need to be captured and stored underground to make synthetic fuel a truly sustainable aviation fuel (SAF)?

DGLR / HAW Prof. Dr.-Ing. Dieter Scholz Tel.: 040 42875 8825 info@ProfScholz.de
 RAeS Richard Sanderson Tel.: 04167 92012 events@raes-hamburg.de

Hamburg Aerospace Lecture Series
 DGLR Bezirksgruppe Hamburg <https://hamburg.dglr.de>
 RAeS Hamburg Branch <https://www.raes-hamburg.de>
 VDI, Arbeitskreis L&R Hamburg <https://www.vdi.de>
 ZAL TechCenter <https://www.zal.aero>

Hamburg Aerospace Lecture Series (AeroLectures). Jointly organized by DGLR, RAeS, ZAL, VDI and HAW Hamburg (aviation seminar). Information about current events is provided by means of an e-mail distribution list. Current lecture program, archived lecture documents from past events, entry in e-mail distribution list. All services via <http://AeroLectures.de>

The **carbon cycle**. CO₂ that is released into the atmosphere has to be captured from the air. In the long run CO₂ from e.g. a coal power plant cannot be used, because there will be no such plants left. The carbon cycle by itself does not make aviation climate neutral, because NO_x and H₂O are still released. How much more CO₂ would need to be captured and stored underground to make synthetic fuel a truly sustainable aviation fuel (SAF)?

Carbon Capture and Storage (CCS)

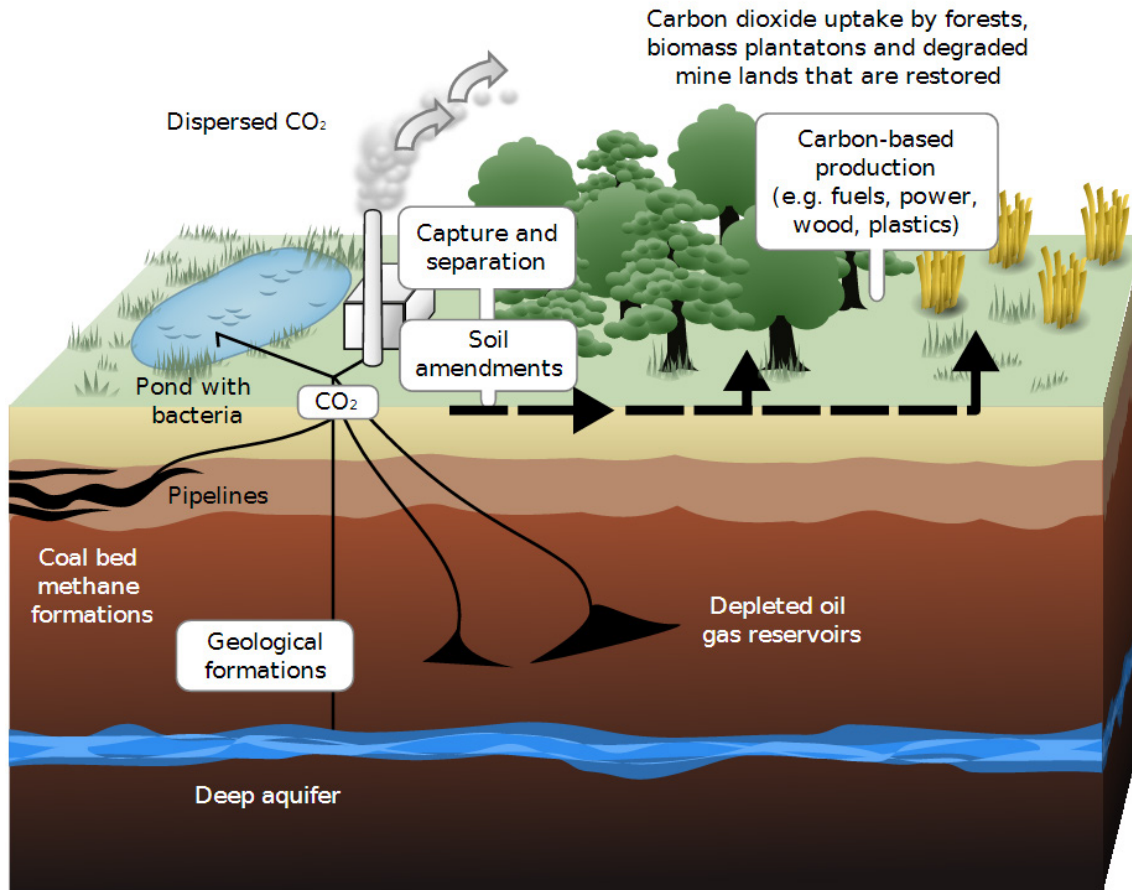

The Electricity Energy Mix

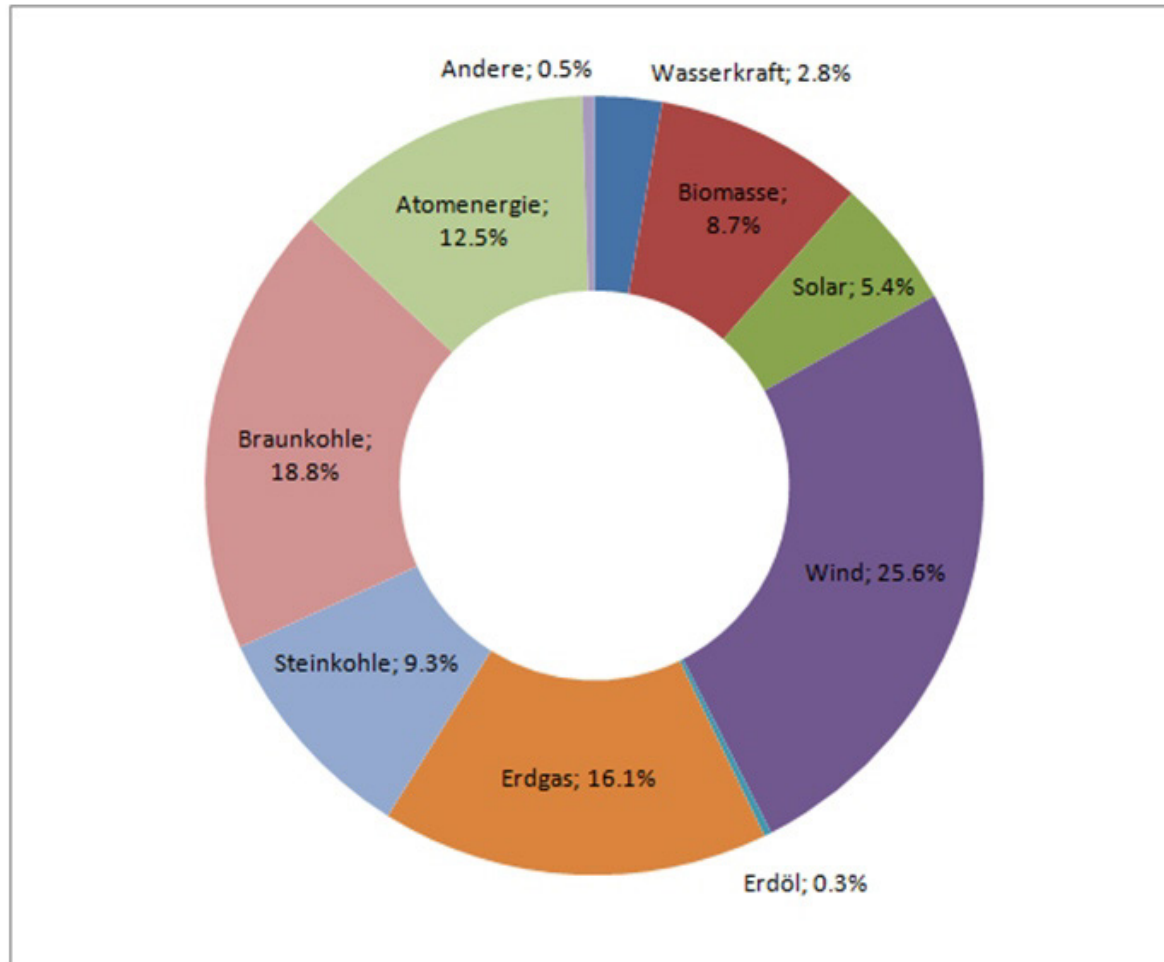

Do Not Use Electricity from the Grid to Power Aviation

<http://ptl.ProfScholz.de>



Substituting coal
is better by a factor of $0.9/0.057 = 15.7$

The idea using PtL fuels in aviation

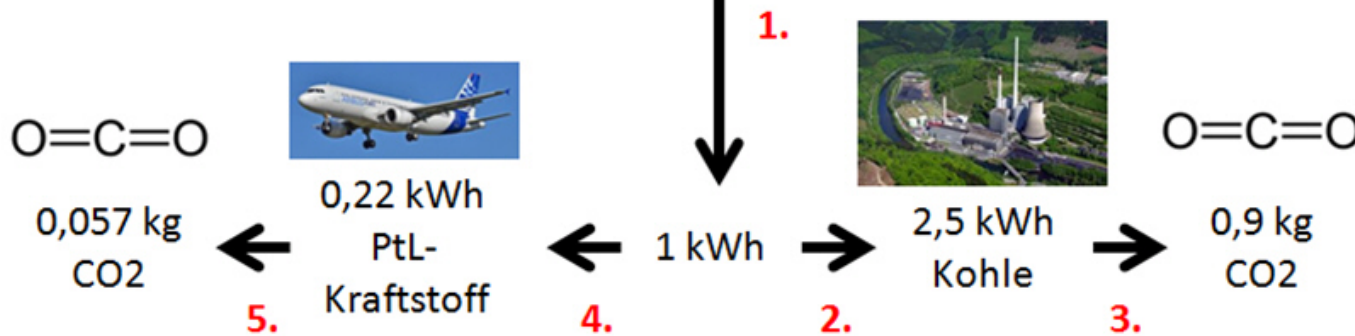

- 1.) 1 kWh erneuerbarer Energie ...
- 2.) ... kann 2,5 kWh Braunkohle im Kohlekraftwerk ersetzen (Wirkungsgrad 40 %);
- 3.) das entspricht 0,9 kg CO2 (0,36 kg CO2 für 1 kWh Energy durch Braunkohle*).
- 4.) ... umgewandelt in Sustainable Aviation Fuel (SAF) bleiben davon nur 0.22 kWh (Wirkungsgrade: 70 % Elektrolyse, 32 % Fischer-Tropsch, EU 2020, S. 44),
- 5.) die nur 0.057 kg CO2 einsparen (0.26 kg CO2 für 1 kWh of Kerosin*).

* UBA, 2016: CO2 Emission Factors for Fossil Fuels. <https://bit.ly/3r8avD1>

Aircraft Fuel Consumption –

Short Range Not Efficient

Use the Train!

- Train is about 3 times more energy-efficient (certainly on short range)
- Train uses 50% Eco Electricity Mix (factor 2)
- Aircraft Factor 3, because in addition non-CO2 effects from:
 - NOX and
 - H2O (AIC)
- 3*2*3: aircraft is 18 times worse on global warming!

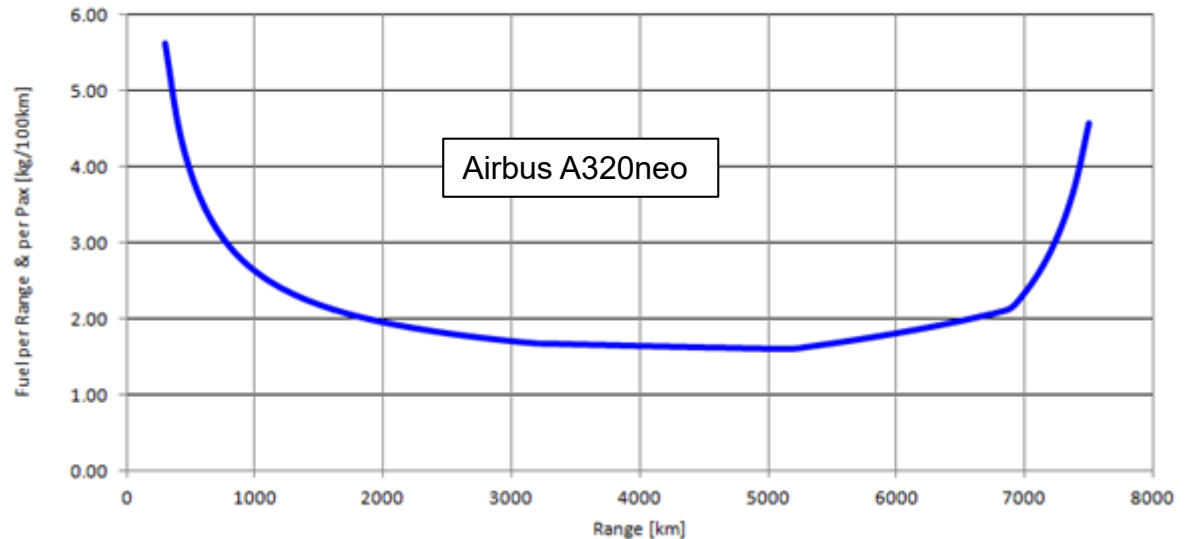

Simple Calculation of Aircraft Fuel Consumption with Public Data:

See details: <https://bit.ly/3mWWho6c>

$$\text{Fuel Consumption} = (MTOW - MZFW) / (R \cdot \text{Seats}) \cdot 100$$

R: Range at maximum payload, from payload range diagram (Document for Airport Planning).

Example calculation with Airbus A320neo:

$$2.2 \text{ kg per } 100 \text{ km per seat} = (73500 \text{ kg} - 62800 \text{ kg}) / (3180 \text{ km} \cdot 150) \cdot 100$$

Can Fuel Consumption and Emissions be Reduced?

Two "Schools" Marching towards Zero Emission

1.) The **traditional** school: "We have to **increase efficiency**."

Critique: "You will never make it to zero emission!"

2.) The **new** school: "We have to **apply new fuels** and do **not care about their overall inefficiency**, because all energy will be renewable energy, which is without harm."

Critique: "You will run out of energy resources!"

Can Fuel Consumption and Emissions be Reduced?

The Way towards Zero Emission

Zero Emission can be achieved by a combination of these principles:

1. apply new technologies to **increase efficiency**, and:
2. apply **new fuels** and with new means of propulsion/flying with no or **less emissions**, and:
3. apply the **carbon (CO₂) cycle** with biofuels or SAF from PtL, and:
4. **compensate** remaining emissions.

Sustainable Aviation Fuel

SAF in Germany

History of Using Synthetic Fuels in **Germany and Beyond**

- Many **demo flights** with SAF since 2008
- 2011: New fuel standard: ASTM D7566
- **Lufthansa**, 2011: Synfuel from Jatropha (oil bean) in regular flight operation for **6 month**.
- Only very few refineries for SAF in the world. One is Neste in Finland.
- 2014 start of **Sunfire** with a pilot plant for 160 l of crude oil per day.
- Land **Hessen**: A pilot plant for E-fuel.
- 15 Million Euro, plus 2 Million Euro p.a. for pilot plant.
- 2019: **Kopernikus- Project P2X** at Karlsruher Instituts für Technologie (**KIT**).
- 2021: Government, aviation industry and others agree on "**PtL-Roadmap for Aviation**".
- Nationalen Luftfahrtkonferenz, 18.06.2021 mentions "**PtL-Development-Platform**"
- Government reserves 1,54 Mrd. Euro for SAF.
- 2021: **PtX-Lab Lausitz**
- **Norsk E-Fuel** plans a plant in Herøya in the South of Norwegen

E-Fuel from Atmosfair

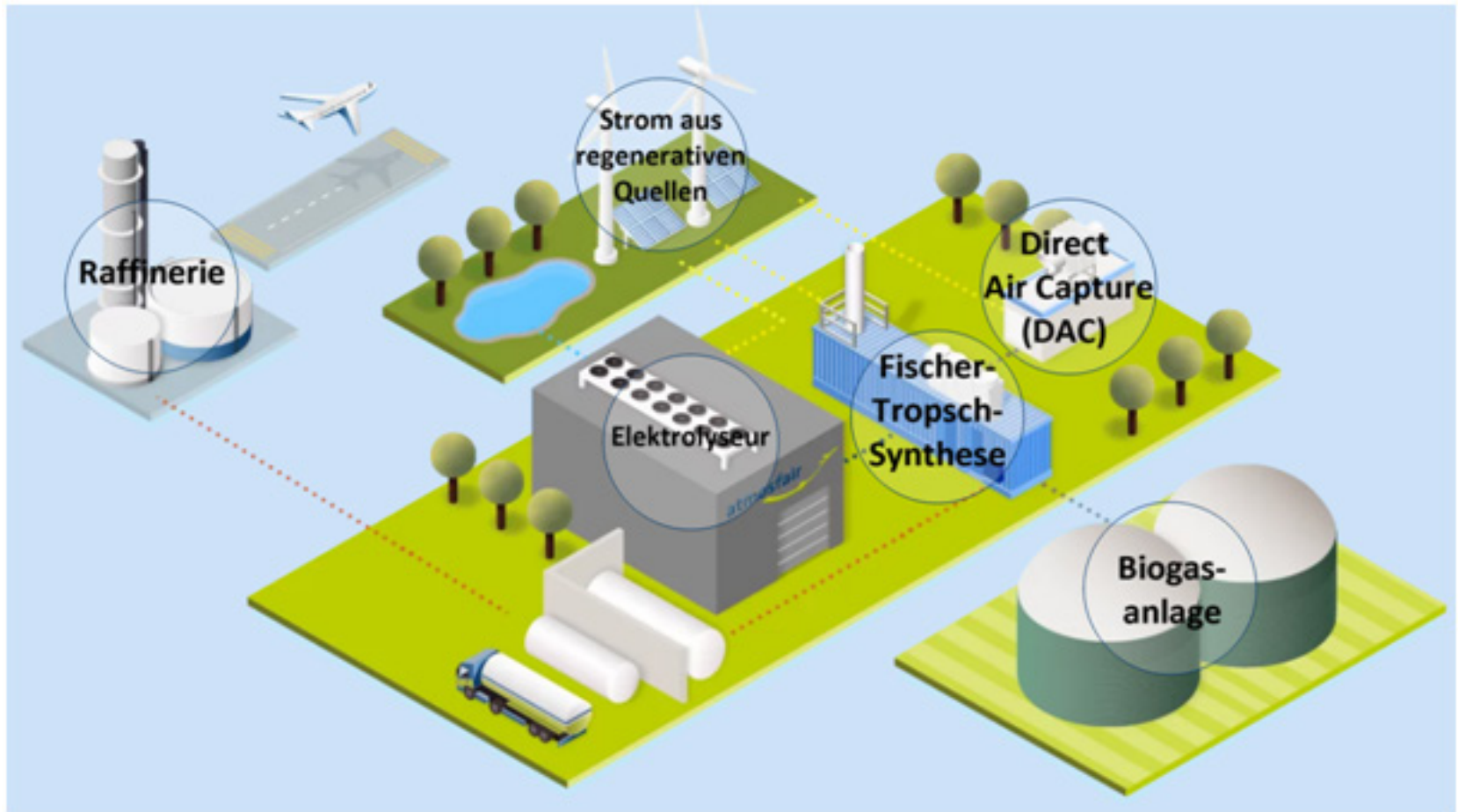

E-Fuel from Atmosfair



- Erneuerbare-Energien-Gesetz (EEG)
- Power Purchase Agreements, PPA
- Herkunftsnachweise (HKN)

Seal (Gütesiegel) for Green Synthetic Kerosene

- The crude oil is produced from **renewable energy**.
- The source of renewable energy is **not in competition with the energy transition**.
- The **CO₂** is obtained 95% from plants (which have captured CO₂ from the air) and 5% directly from the air (through Direct Air Capture, DAC). This makes a CO₂ cycle possible. CO₂ is first removed from the atmosphere and then emitted back into the atmosphere in the aircraft through conventional combustion. The process is therefore CO₂-neutral.
- Up to crude oil production, **everything is done at one location**. As a result, no further energy is required for transport and no overhead lines are used to transport the electricity.
- The production is **not done on a laboratory scale** (production of about 1 kg of fuel per day), but on a much larger scale (production of about 1000 kg of fuel per day). This is very little compared to the fuel requirements of the aircraft, but it is a first step.

Virtual E-Fuel – Bilanzielle Vermarktung

- In this system, the **customer pays for** a certain amount of **SynCrude** that the Atmosfair/Solarbelt physically produced for him and which the refinery brings to market.
- The associated **CO2 reduction is certified** by Atmosfair/Solarbelt with an independently tested seal of quality (TÜV) for the buyer and allocates the CO2 to the customer, although the kerosene physically co-processed with other crude oil and delivered to all airports.
- The **customer pays** for this directly **to Atmosfair/Solarbelt**.
- Established supply routes for crude oil and delivery routes for kerosene **are unchanged**.

Kerosene and Hydrogen Emissions from Aviation

in more Detail

Equivalent CO₂ Mass

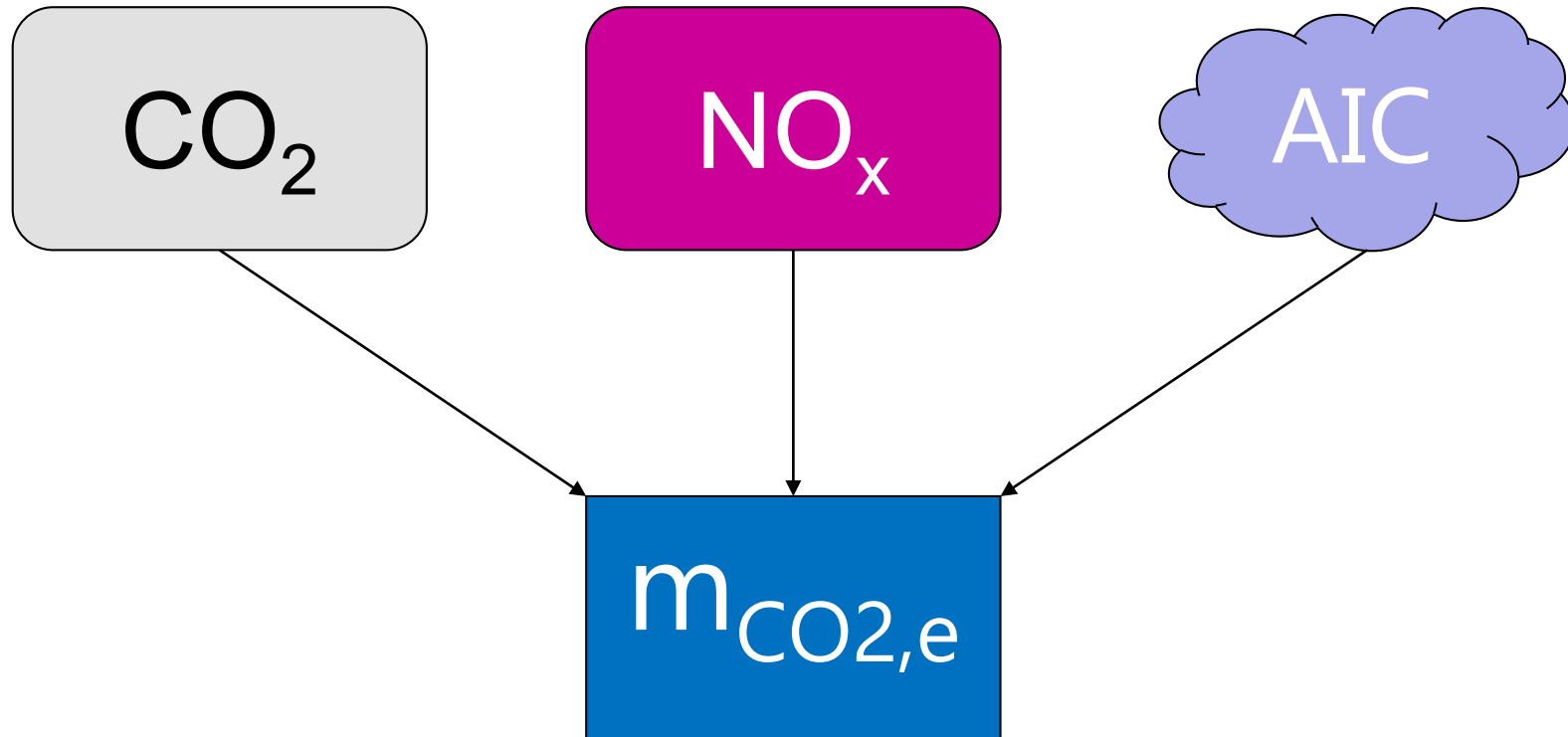

CAERS, Brecht, SCHOLZ, Dieter, 2020. *Conditions for Passenger Aircraft Minimum Fuel Consumption, Direct Operating Costs and Environmental Impact*. German Aerospace Congress 2020 (DLRK 2020), Online, 01.-03.09.2020.
 Available from: <https://doi.org/10.5281/zenodo.4068135>

Aviation Emissions and Climate Impact

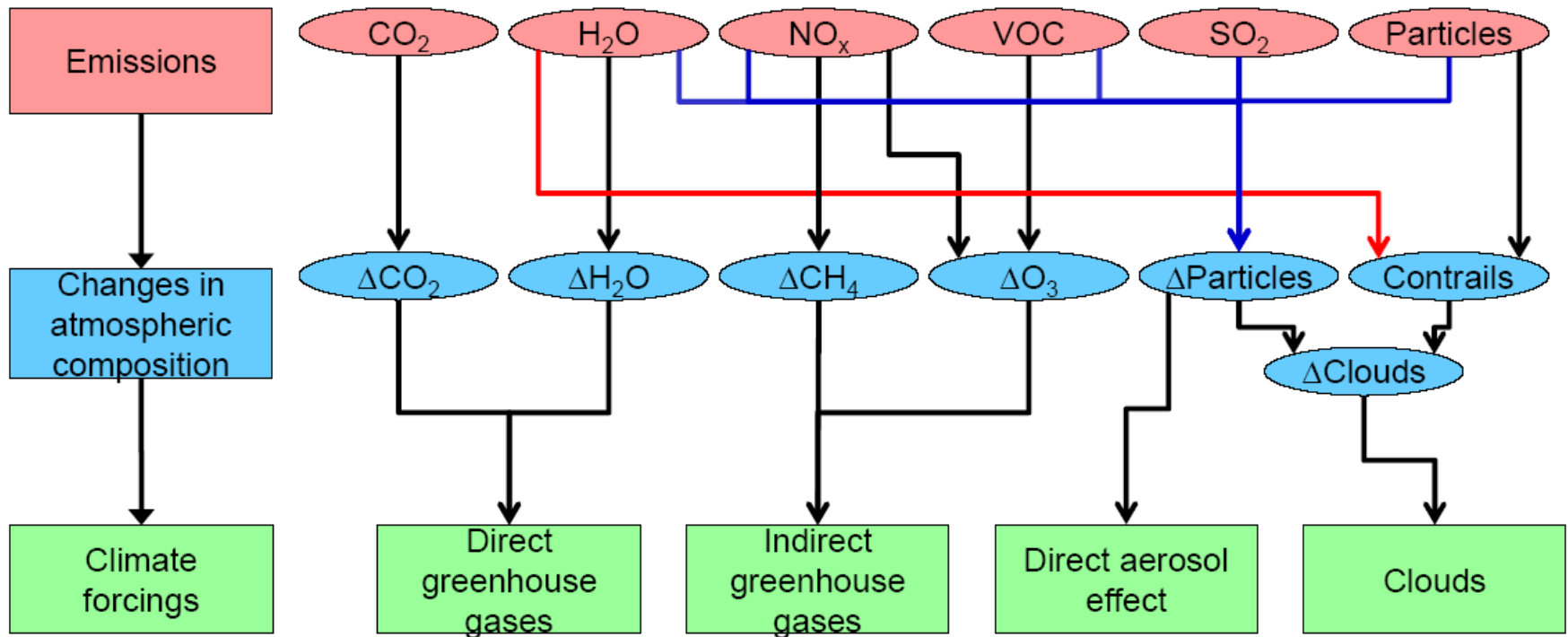



CO₂: **Long term influence**

Non-CO₂: **Short term influence** (immediate mitigation is possible)

RAPP, Markus, 2019. Perspektive: Wasserstoff & Hybride. Meeting: "Emissionsfreies Fliegen-wie weit ist der Weg?", Berlin, 13.11.2019

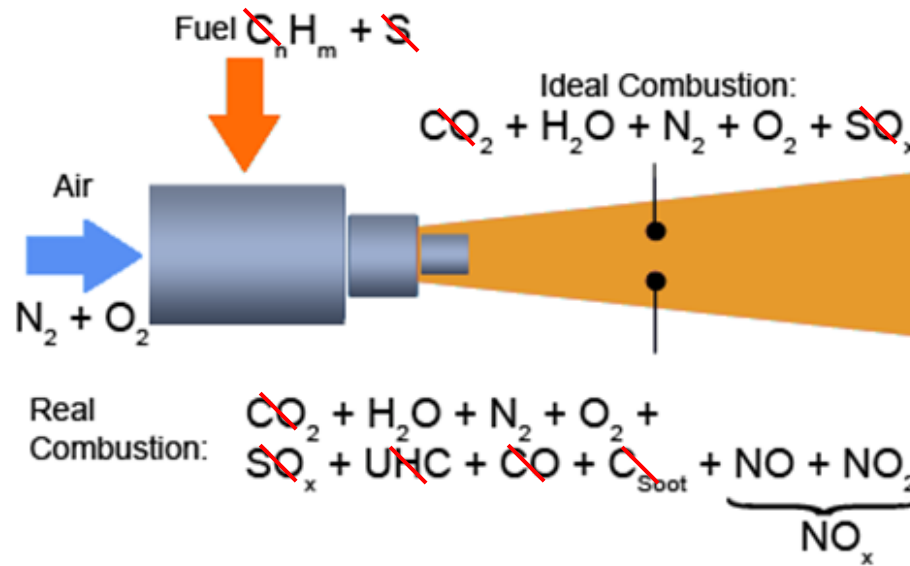
Kerosene and LH2 Combustion



 not included in LH2 combustion

EI_{NOx}

↑

EMEP/EEA Guidebook
<https://www.eea.europa.eu>

m_F

↑

Own Fuel Calculation

Altitude-Dependent Equivalent CO2 Mass

$$m_{CO_2,eq} = \frac{EI_{CO_2} \cdot f_{NM}}{n_{seat}} \cdot 1 + \frac{EI_{NO_x} \cdot f_{NM}}{n_{seat}} \cdot CF_{midpoint,NO_x} + \frac{R_{NM}}{R_{NM} \cdot n_{seat}} \cdot CF_{midpoint,AIC}$$

Sustained Global Temperature Potential, SGTP (similar to GWP):

$$CF_{midpoint,NO_x}(h) = \frac{SGTP_{O_{3S},100}}{SGTP_{CO_2,100}} \cdot s_{O_3,S}(h) + \frac{SGTP_{O_{3L},100}}{SGTP_{CO_2,100}} \cdot s_{O_3,L}(h) + \frac{SGTP_{CH_4,100}}{SGTP_{CO_2,100}} \cdot s_{CH_4}(h)$$

$$CF_{midpoint,cloudiness}(h) = \frac{SGTP_{contrails,100}}{SGTP_{CO_2,100}} \cdot s_{contrails}(h) + \frac{SGTP_{cirrus,100}}{SGTP_{CO_2,100}} \cdot s_{cirrus}(h)$$

Species	Emission Index, EI (kg/kg fuel)
CO ₂	3,15
H ₂ O	1,23
SO ₂	2,00 · 10 ⁻⁴
Soot	4,00 · 10 ⁻⁵

Species	SGTP _{1,100}
CO ₂ (K/kg CO ₂)	3,58 · 10 ⁻¹⁴
Short O ₃ (K/kg NO _x)	7,97 · 10 ⁻¹²
Long O ₃ (K/NO _x)	-9,14 · 10 ⁻¹³
CH ₄ (K/kg NO _x)	-3,90 · 10 ⁻¹²
Contrails (K/NM)	2,54 · 10 ⁻¹³
Contrails (K/km)	1,37 · 10 ⁻¹³
Cirrus (K/NM)	7,63 · 10 ⁻¹³
Cirrus (K/km)	4,12 · 10 ⁻¹³

EI emission index
f_{NM} fuel consumption per NM or km
R_{NM} range in NM or km
CF characterization factor

Cirrus/Contrails = 3.0

water vapor not considered

AIC aviation-induced cloudiness

$$s_{O_{3,L}}(h) = s_{CH_4}(h)$$

$$s_{contrails}(h) = s_{cirrus}(h) = s_{AIC}(h)$$

Altitude-Dependent Equivalent CO2 Mass

$$m_{CO_2,eq} = \frac{EI_{CO_2} \cdot f_{NM}}{n_{seat}} \cdot 1 + \frac{EI_{NOx} \cdot f_{NM}}{n_{seat}} \cdot CF_{midpoint,NOx} + \frac{R_{NM}}{R_{NM} \cdot n_{seat}} \cdot CF_{midpoint,AIC}$$

↓ units only

$$\frac{kg\ CO_2}{NM \cdot n_{seat}} =$$

$$\frac{kg\ CO_2/kg\ fuel \cdot kg\ fuel/NM}{n_{seat}} \cdot 1 + \frac{kg\ NOx/kg\ fuel \cdot kg\ fuel/NM}{n_{seat}} \cdot \frac{kg\ CO_2}{kg\ NOx} + \frac{NM}{NM \cdot n_{seat}} \cdot \frac{kg\ CO_2}{NM}$$

SCHWARTZ, Emily, KROO, Ilan M., 2009. *Aircraft Design: Trading Cost and Climate Impact*. 47th AIAA Aerospace Sciences Meeting including The New Horizons Forum and Aerospace Exposition, 05.01.-08.01.2009, Orlando, Florida, AIAA 2009, No.1261. Available from: <https://doi.org/10.2514/6.2009-1261>

JOHANNING, Andreas, SCHOLZ, Dieter, 2014. *Adapting Life Cycle Impact Assessment Methods for Application in Aircraft Design*. German Aerospace Congress 2014 (DLRK 2014), Augsburg, 16.-18.09.2014. Available from: <https://nbn-resolving.org/urn:nbn:de:101:1-201507202456>. Download: <http://Airport2030.ProfScholz.de>

Altitude-Dependent Equivalent CO2 Mass

E.g.:
$$CF_{midpoint, cloudiness}(h) = \frac{SGTP_{contrails, 100}}{SGTP_{CO_2, 100}} \cdot s_{contrails}(h) + \frac{SGTP_{cirrus, 100}}{SGTP_{CO_2, 100}} \cdot s_{cirrus}(h)$$

$$s_{contrails}(h) = s_{cirrus}(h) = s_{AIC}(h)$$

Forcing Factor $s = f(h)$

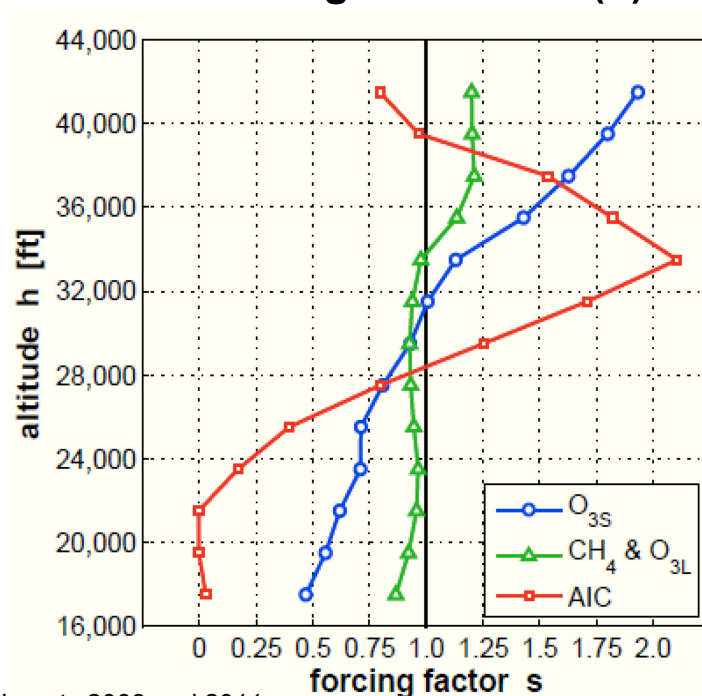

Schwartz 2009 and 2011

- The curves go along with the ICAO Standard Atmosphere (ISA) applicable for average latitudes. With a first approximation, the curves could be adapted to other latitudes by stretching and shrinking them proportionally to the altitude of the tropopause.
- The curves from SVENSSON 2004 (Fig. 1) show similar shapes. However, the importance of AIC is not yet as distinct.

SVENSSON, Fredrik, HASSELROT, Anders, MOLDANOVA, Jana, 2004. Reduced Environmental Impact by Lowered Cruise Altitude for Liquid Hydrogen-Fuelled Aircraft. In: *Aerospace Science and Technology*, Vol. 8 (2004), Nr. 4, pp. 307–320. Available from: <https://doi.org/10.1016/j.ast.2004.02.004>

Altitude-Dependent Equivalent CO2 Mass

Forcing Factor $s = f(h)$

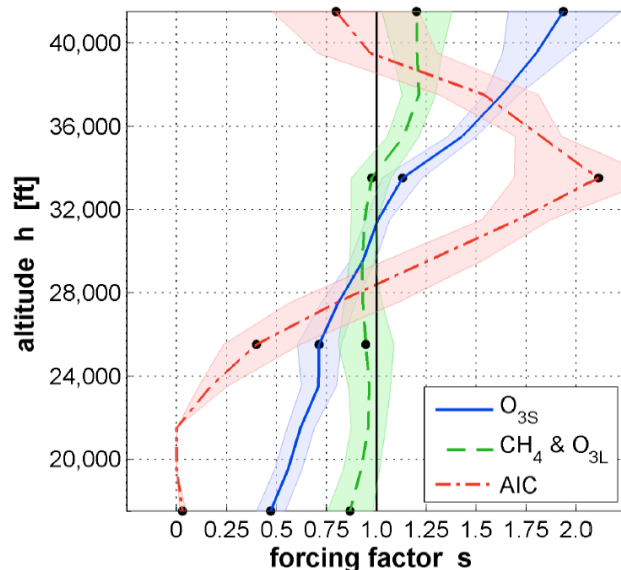

Forcing factors (lines) with **66% likelihood ranges** (shaded areas). Altitudes with forcing factors based on radiative forcing data with independent probability distributions. (SCHWARTZ 2011)

Based on KÖHLER 2008 and RÄDEL 2008.

SCHWARTZ DALLARA, Emily, 2011. *Aircraft Design for Reduced Climate Impact*. Dissertation. Stanford University. Available from: <http://purl.stanford.edu/yf499mg3300>

KÖHLER, Marcus O., RÄDEL, Gaby, DESSENS, Olivier, SHINE, Keith P., ROGERS, Helen L., WILD, Oliver, PYLE, John A., 2008. Impact of Perturbations to Nitrogen Oxide Emissions From Global Aviation. In: *Journal of Geophysical Research*, 113. Available from: <https://doi.org/10.1029/2007JD009140>

RÄDEL, Gaby, SHINE, Keith P., 2008. Radiative Forcing by Persistent Contrails and Its Dependence on Cruise Altitudes. In: *Journal of Geophysical Research*, 113. Available from: <https://doi.org/10.1029/2007JD009117>

Aviation-Induced Cloudiness: Contrail Cirrus & Persistent Contrails

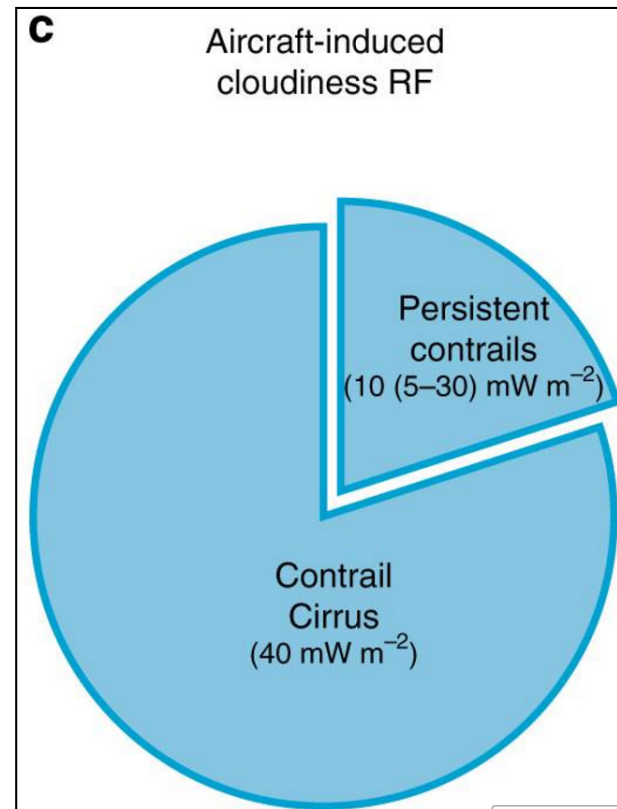
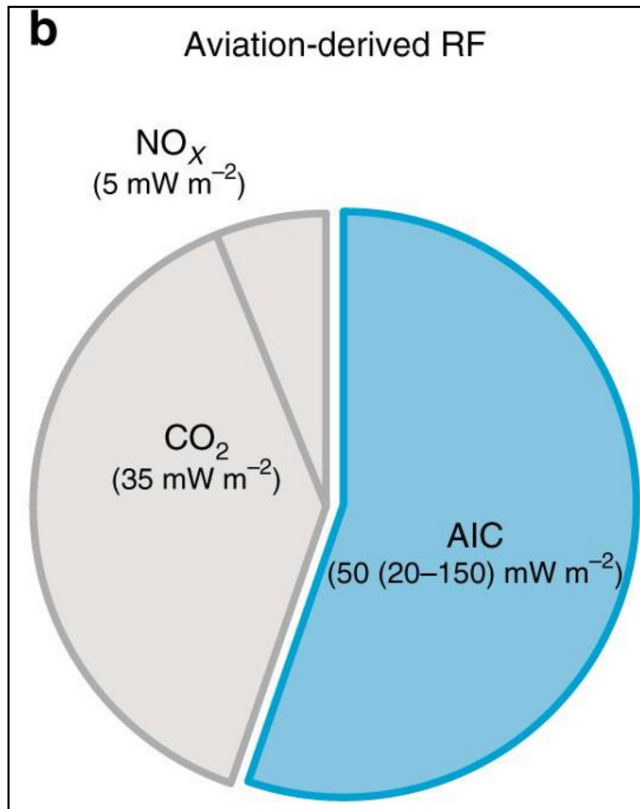

Cirrus/Contrails = 4.0

- (b) Aviation forcing components, of which aviation-induced cloudiness (AIC) account for more than half.
 (c) Breakdown of AIC radiative forcing into contrail cirrus and persistent contrails.

KÄRCHER, Bernd, 2018. Formation and Radiative Forcing of Contrail Cirrus. In: *Nature Communications*, Vol. 9, Article Number: 1824. Available from: <https://doi.org/10.1038/s41467-018-04068-0>

Relative Contributions to Global Warming

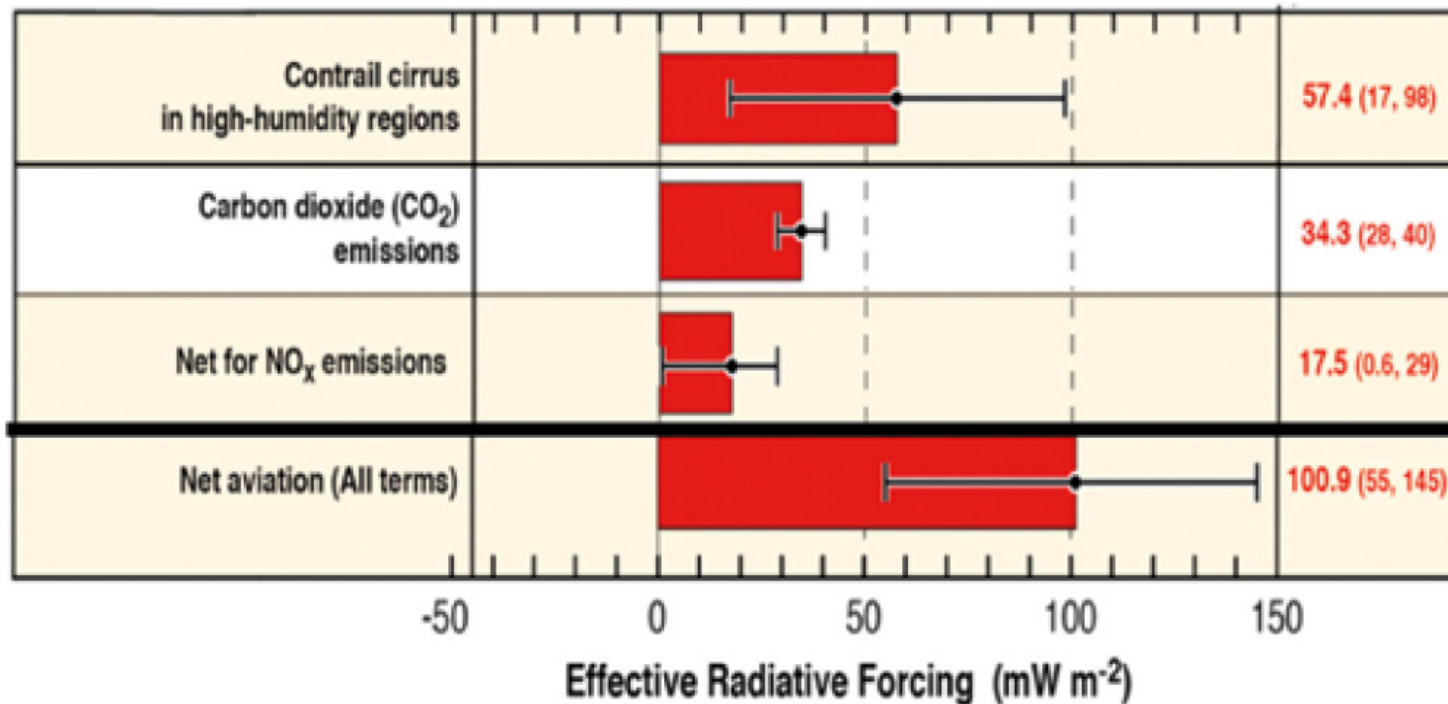

This can be compared to equivalent CO₂ at peak AIC ("33548 ft") according to the model by SCHWARTZ 2009 due to

- 54.7% AIC
- 23.6% CO₂
- 21.7% NO_x

Contrail Radiative Forcing (CRF) as a Function of Fuel Flow (ff)

Aircraft	A319-111	A340-311	A380-841
Encounter time	09:14–09:27	08:45–08:48	12:14–12:29
Contrail altitude (km)	10.5–10.7	10.5–10.7	10.3–10.7
Latitude	52.91° N	53.35° N	52.37° N
Longitude	8.06° E	8.94° E	9.66° E
Pressure p (hPa)	241	242	241
Temperature T (K)	217	217	218
T_C (K)	223.5	223.6	223.6
Brunt–Väisälä frequency	0.0170	0.0126	0.0132
NO_y (nmol mol ⁻¹)	4.3	4.4	6.7
EI_{NO_x} (g kg ⁻¹)	8.7	11.6	19.7
RHI (%)	91	94	92
Contrail age (s)	105–118	80–90	102–115
Fuel flow (Mg engine ⁻¹ h ⁻¹)	0.9	1.3	3.6
Fuel flow rate (kg km ⁻¹)	2.2	6.4	15.9
Aircraft engine	CFM56-5B6/P	CFM56-5C2	Trent 970-84
Mach	0.76	0.737	0.85
Fuel sulphur content (mg kg ⁻¹)	1155	940	–
Aircraft weight (Mg)	47	150	508
Wingspan (m)	34.09	60.30	79.81

τ	ff	τ / ff [km/kg]	aircraft
0.25	2.2	= 0.114	A319
0.55	6.4	= 0.0859	A340
0.94	15.9	= 0.059	A380

update pending

JERßBERGER, Philipp, et al. Aircraft type influence on contrail properties. Atmospheric Chemistry and Physics, 2013, 13. Jg., Nr. 23, S. 11965-11984. Available from: <https://10.5194/acp-13-11965-2013>

Aircraft	n_{ice} (cm ⁻³)	D_{eff} (µm)	Projected surface area A (µm ² cm ⁻³)	IWC (mg m ⁻³)	Extinction (km ⁻¹)	Vertical extension (m)	Optical depth τ
A319	162±18	5.2(±1.5)	0.93(±0.14)×10 ³	4.1(±1.0)	2.1(±0.3)	120	0.25
A340	164±0.11	5.8(±1.7)	1.12(±0.17)×10 ³	4.0(±1.0)	2.5(±0.4)	220	0.55
A380	235±10	5.9(±1.7)	1.45(±0.22)×10 ³	5.2(±1.3)	3.2(±0.5)	290	0.94

Contrail Radiative Forcing (CRF) as a Function of Fuel Flow (ff)

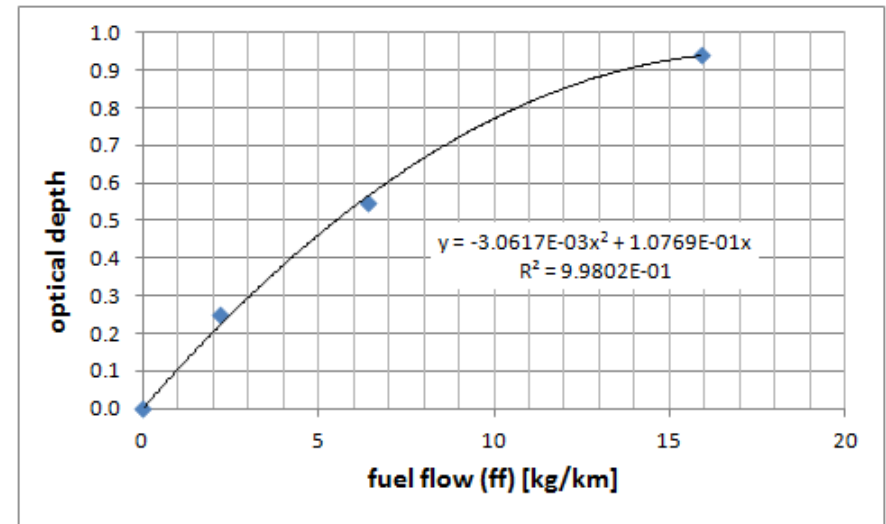
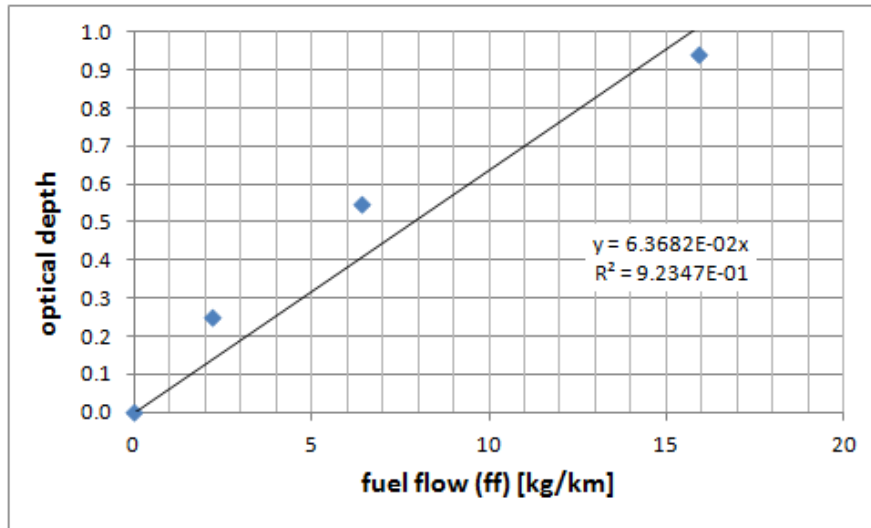

The quadratic regression (right) fits amazingly well. However, from the small number of aircraft tested, no such general law may be derived from it.

The climate model by SCHWARTZ 2009, which calculates AIC effects only based on contrail length (flight distance) could be extended to include fuel burn (in kg/km) into the equation!
This remains to be done!

update pending

Schmidt-Appleman Criterion for Contrail Formation

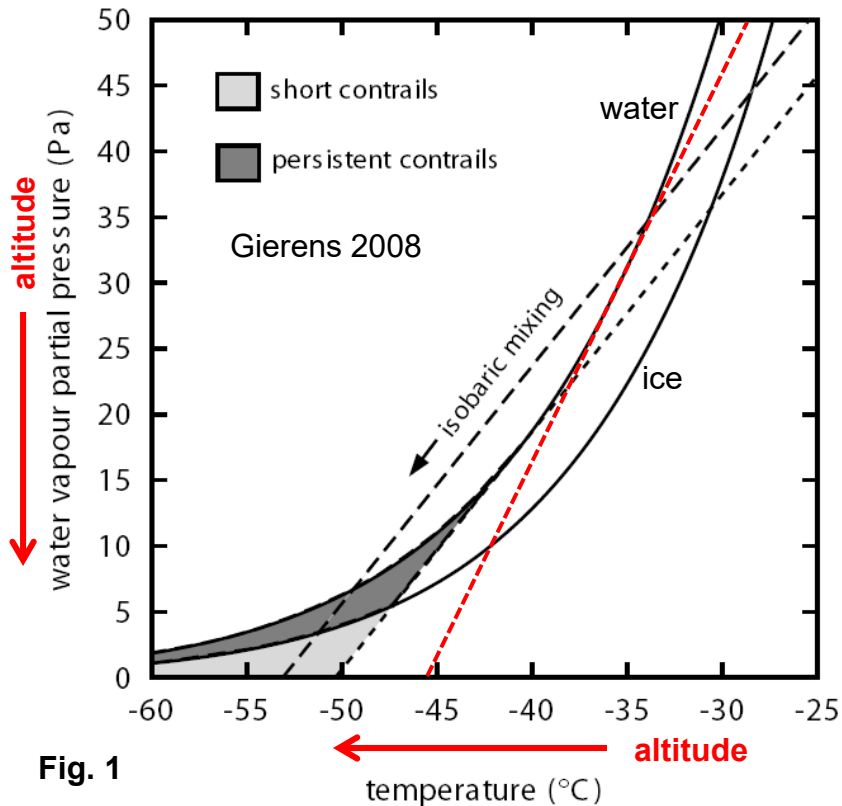

Fig. 1

G is the slope of the dotted line.
The dotted line is tangent to the water saturation line.

The mixing process is assumed to take place isobarically, so that on a $T-e$ diagram the mixing (phase) trajectory appears as a straight line (e is the partial pressure of water vapour in the mixture, T is its absolute temperature, see Fig. (1)). The slope of the phase trajectory, G (units Pa/K), is characteristic for the respective atmospheric situation and aircraft/engine/fuel combination. G is given by

$$G = \frac{EI_{H_2O} p c_p}{\varepsilon Q (1 - \eta)}$$

where ε is the ratio of molar masses of water and dry air (0.622), $c_p = 1004$ J/(kg K) is the isobaric heat capacity of air, and p is ambient air pressure. G depends on fuel characteristics (emission index of water vapour, $EI_{H_2O} = 1.25$ kg per kg kerosene burnt; chemical heat content of the fuel, $Q = 43$ MJ per kg of kerosene), and on the overall propulsion efficiency η of aircraft. Modern airliners have a propulsion efficiency (η) of approximately 0.35.

A steep dotted line (large G) means:
Contrails more often and also at lower altitudes.

GIERENS, Klaus, LIM, Limg, ELEFATHERATOS, Kostas, 2008. A Review of Various Strategies for Contrail Avoidance. In: The Open Atmospheric Science Journal, 2008, 2, 1-7. Available from: <https://doi.org/10.2174/1874282300802010001>

Heating Value Q, Emission Index EI, and Slope G

fuel	Q [MJ/kg]	EI _{H₂O} [kg/kg]	EI _{H₂O} /Q [kg/MJ]	G _{H₂} /G _{Jet-A1}
H2	120	8,94	0,0745	2,58
Jet –A1	43	1,24	0,0288	

The **slope G** of the dotted line is **2,58 times steeper** in case of LH2 combustion. This means: **Contrails more often** and **also at lower altitudes**.

2,58 times more water vapor is produced with LH2 combustion compared to kerosene combustion (for the same energy used).

Literature Review: Hydrogen and Water Emissions

Types of water based emissions:

- water **vapor** emissions
- aviation-induced cloudiness (AIC)
 - line-shaped **contrails**
 - **cirrus clouds** (aged contrails)

*the **water vapour** RF [radiative forcing] increases in the cryoplane case, but by absolute magnitude this **contribution** remains the **smallest**.*

Ponater, 2006, <https://doi.org/10.1016/j.atmosenv.2006.06.036>

*For H2 turbines and fuel cells, as they use H2 as fuel, **2.55 times more water vapor** is formed compared to kerosene combustion [for the same energy content].*

*H2 turbines emit **less soot** compared to kerosene; therefore, their emission leads to **optically thinner ice crystals** and thus lower climate impact. [Reduction assumed down to **60%** (40% reduction). See table on page 76 in report.]*

EU, 2020. Hydrogen-Powered Aviation. <https://doi.org/10.2843/471510>. Archived at: <https://perma.cc/BJJ6-5L74>

Literature Review: Hydrogen and Water Emissions

Current *state of knowledge does not allow a conclusive assessment* whether the net radiative impact of cryoplane contrails will be smaller or larger than that of conventional contrails. Uncertainty with respect to radiative forcing arises mainly from insufficient knowledge regarding the mean effective ice crystal radius for both conventional and, especially, cryoplane contrails.

it would be *strongly desirable* to compare model results to observations, i.e., *measurements* taken in the wake of a *prototype cryoplane*, which presently *does not exist*.

crystal radius is about a factor of 0.3 smaller for conventional contrails than for cryoplane contrails. [Hence, the radius of cryoplane's ice *crystals is 3.33 times larger* and the volume is 37 times larger. That means with 2.58 the amount of water there are only 7% of the ice crystals by numbers compared to kerosene. The area of the ice crystals is 11 time larger and the *coverage of the sky is only 77.4% of that for kerosene*. Everything calculated from simple geometry.]

the substitution of conventional aviation by a fleet of cryoplanes would lead to ... *increase in the coverage* with all contrails by a *factor of 1.2*

However, contrails are only visible (from satellite or an Earth-bound observer) if their optical depth exceeds a certain threshold value. In our studies, we have used a visibility-threshold of 0.02 and, therefore, have distinguished between the "visible" contrail cover and the cover with "all" contrails. Though, as just explained, the *coverage with all contrails increases all over the world* in our cryoplane simulations, the *coverage with visible contrails decreases over a substantial part of the globe*

Marquart 2005, <https://doi.org/10.1127/0941-2948/2005/0057>

Literature Review: Hydrogen and Water Emissions

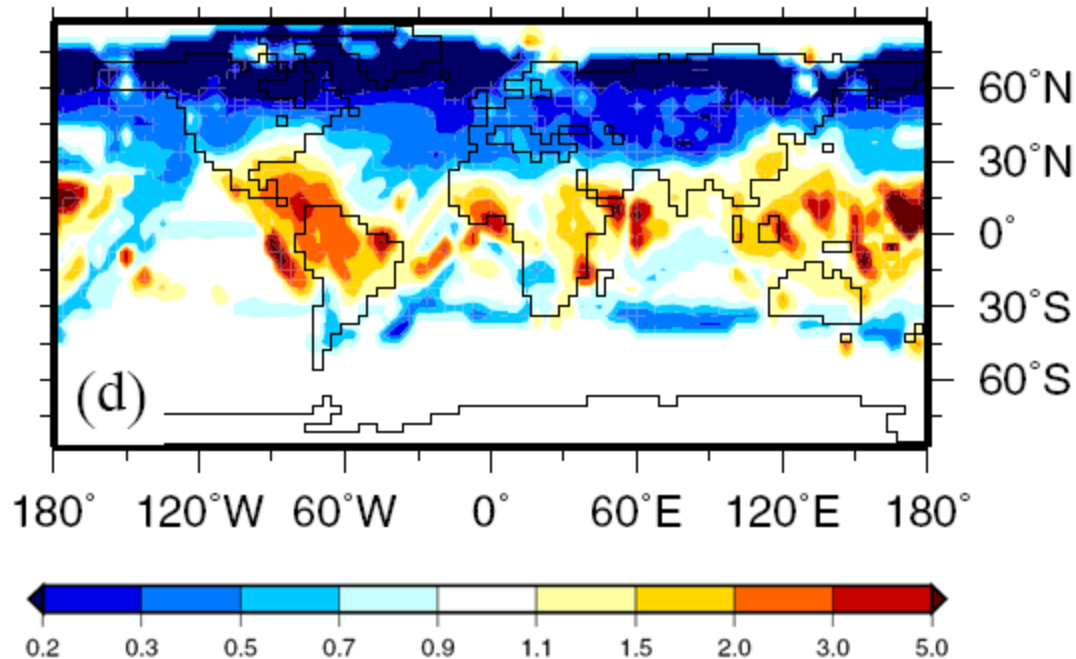

Change in annual mean total *contrail cover* for the time slice 2015 if the *conventional fleet of aircraft is replaced by a fleet of cryoplanes*. (d) *ratio cryoplane/conventional for visible contrails*.

Marquart 2005, <https://doi.org/10.1127/0941-2948/2005/0057>

Literature Review: Hydrogen and Water Emissions

the global mean radiative forcing of cryoplane contrails is simulated to be by about ... 30% [lower] in 2050 compared to the radiative forcing of conventional contrails. The global mean decrease in radiative forcing results from the decrease in contrail optical depth, which outweighs the effect of increased contrail cover due to the higher specific emission of water vapour. However, in tropical regions, where it is often too warm for contrail formation in the case of conventional aircraft, the increase in contrail cover for the cryoplane case is found to be relatively strong, leading to an increase in radiative forcing there.

Marquart 2005, <https://doi.org/10.1127/0941-2948/2005/0057>

Contrail cirrus, consisting of linear contrails and the cirrus cloudiness arising from them, yields the largest positive net (warming) ERF term followed by CO₂ and NO_x emissions.

Lee, 2020, <https://doi.org/10.1016/j.atmosenv.2020.117834>

Flying at lower altitudes can also lead to contrail reduction in the mid-latitudes.

Gierens, 2008, <https://doi.org/10.2174/1874282300802010001>

Cryoplanes should cruise at an altitude of about 2–3 km below where conventional aircraft cruise today. At this reduced flight level, the contribution to global warming from the cryoplane is slightly less than about 15% of that of the conventional aircraft cruising at the datum level. In addition to the aspects considered here, reducing the flight altitude will help to avoid the formation of contrails. Inevitably, this change in cruise altitude causes increased aircraft investments and operating costs.

Svensson, 2004, <https://doi.org/10.1016/j.ast.2004.02.004>

Hydrogen Combustion at Altitude and the "Ice Sphere Model"

- Hydrogen burns without soot and therefore without condensation nuclei. The water from the combustion condenses on the **few condensation nuclei** in the atmosphere.
- There is **more water by a factor of 2.58**.
- The ice crystals are bigger, but there are fewer ice crystals.
- **Assumption:** If the **effective diameter of the ice crystals** (imagined as a sphere) is **3.33 times as large as in the case of kerosene combustion**, then the volume is $3.33 \times 3.33 \times 3.33 = 37$ times as large and the number spheres goes down by a factor of $1/37$. The cross-section of the sphere is $3.33 \times 3.33 = 11$ times as big. Taking the increased amount of water into account, the **sky is covered by only $11/37 \times 2.56 = 77.4\%$** compared to burning kerosene (with the same amount of energy).

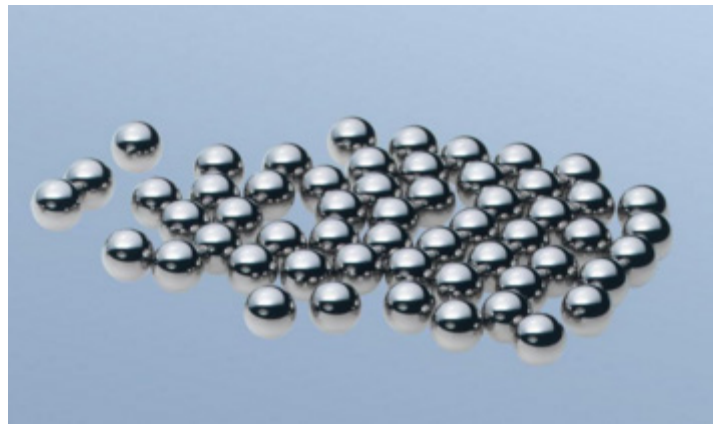

Hydrogen: Less NOx in Lean Combustion

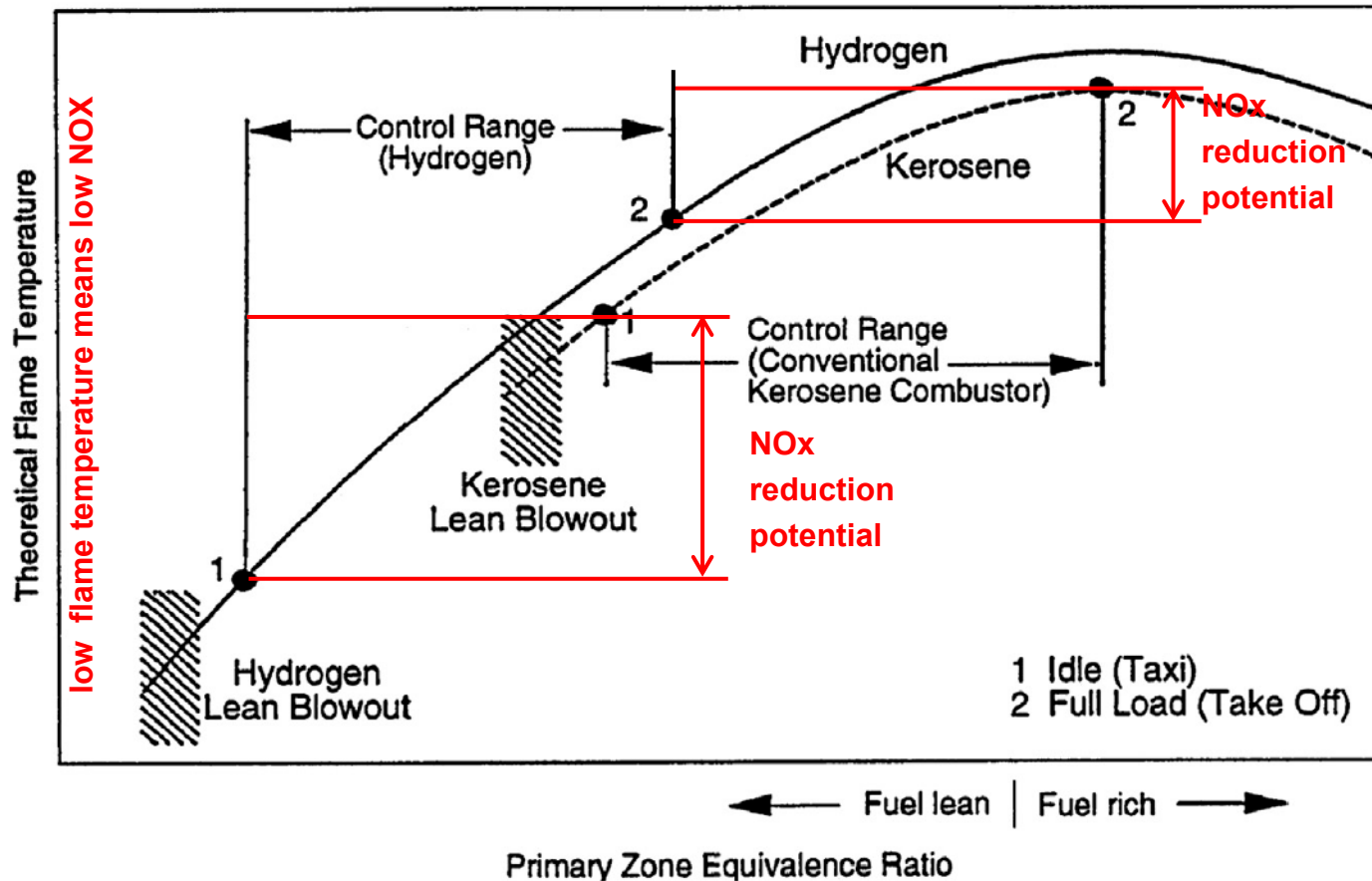

Primary effect:
Hydrogen burns **hotter** and produces **more NOx**.

Secondary effect:
Hydrogen allows **leaner** combustion for **less NOx**.

NOx reduction potential, but **not zero NOx** for LH2 combustion.

KHANDELWAL et al., 2013. Hydrogen powered aircraft: The future of air transport. In: *Progress in Aerospace Sciences*. Vol. 60, July 2013, pp. 45-59. Available from: <https://doi.org/10.1016/j.paerosci.2012.12.002>

Literature Review: Hydrogen and NOx Emissions

For H2 turbines (vs. kerosene), hydrogen's *wider flammability limits* enable *leaner combustion* that results in *lower flame temperatures*. In addition, higher burning velocities and diffusivity allow for higher reaction rates and faster mixing respectively, resulting in lower residence time. These factors cumulatively contribute to lower thermal NOx and allow for shorter combustor designs. As the total amount of *NOx reduction* is *promising but still uncertain*, a range of 50 percent to 80 percent compared to kerosene was considered. Translating this to GWP and in reference to kerosene aircraft, we used a range of GWP for NOx from H2 turbines of 10 percent (lower limit) to 75 percent (upper limit), *resulting in an average GWP value of 35 percent*.

EU, 2020. Hydrogen-Powered Aviation. <https://doi.org/10.2843/471510>. Archived at: <https://perma.cc/BJJ6-5L74>

As for the NOx emissions when burning hydrogen, *theoretically* there is, in spite of the *higher stoichiometric flame temperature of hydrogen*, a potential to achieve lower emissions as compared with engines using kerosene. The main reason for this is that the hydrogen flame has a *wider flammability range*; particularly the *lean limit is substantially lower* than that encountered for kerosene flames. Therefore the entire operating range may be shifted further into the lean region, with considerably *reduced NOx emissions* as a consequence.

Svensson, 2004, <https://doi.org/10.1016/j.ast.2004.02.004>

Calculation of the Emission Characteristics of Aircraft Kerosene and Hydrogen Propulsion – A Comparison with Primary Effects

Altitude [ft]	rel. to kero
18000	-1%
24000	59%
30000	144%
33548	163%
36000	149%
41000	112%

<https://doi.org/10.7910/DVN/DLJUUK>

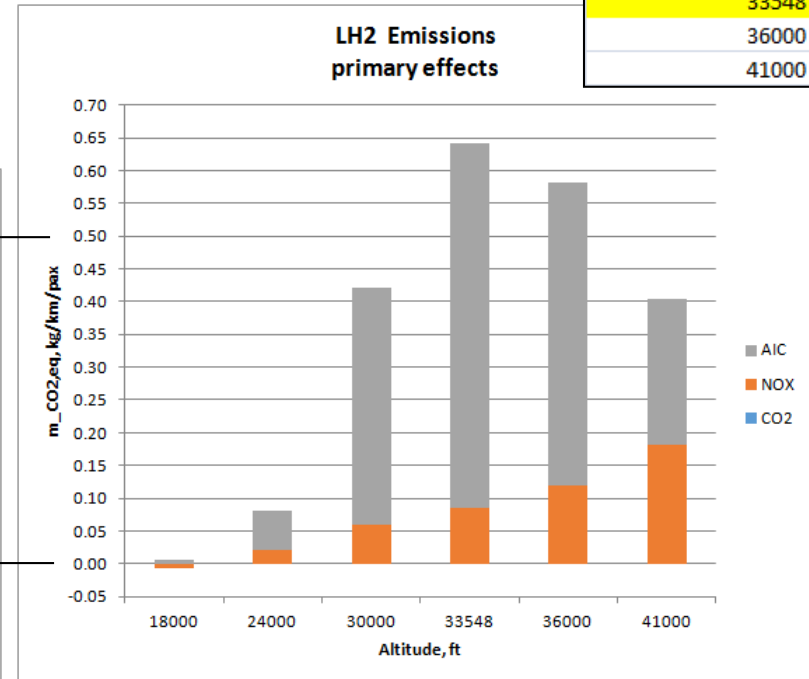
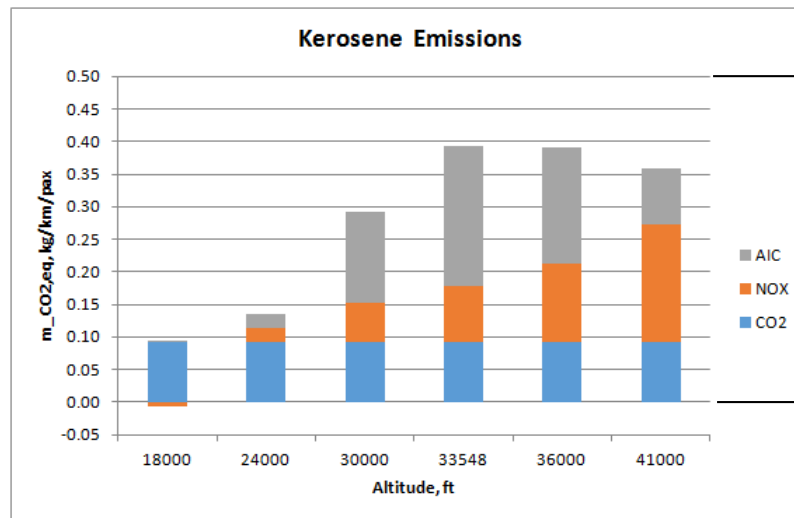

The method from SCHWARTZ 2009 was applied and adapted. Hydrogen combustion has 2.58 times more water emissions. If this primary effect is applied to aviation-induced cloudiness (AIC) with its line-shaped contrails and cirrus clouds, the equivalent CO2 mass would be 50% higher as for kerosene. Hydrogen flame temperature is higher (without applying special technologies) and as such NOx would be higher. It is assumed here that NOx are the same as for kerosene.

Calculation of the Emission Characteristics of Aircraft Kerosene and Hydrogen Propulsion – A Comparison with Secondary Effects

Altitude [ft]	rel. to kero
18000	0%
24000	21%
30000	52%
33548	59%
36000	53%
41000	40%

<https://doi.org/10.7910/DVN/DLJUUK>

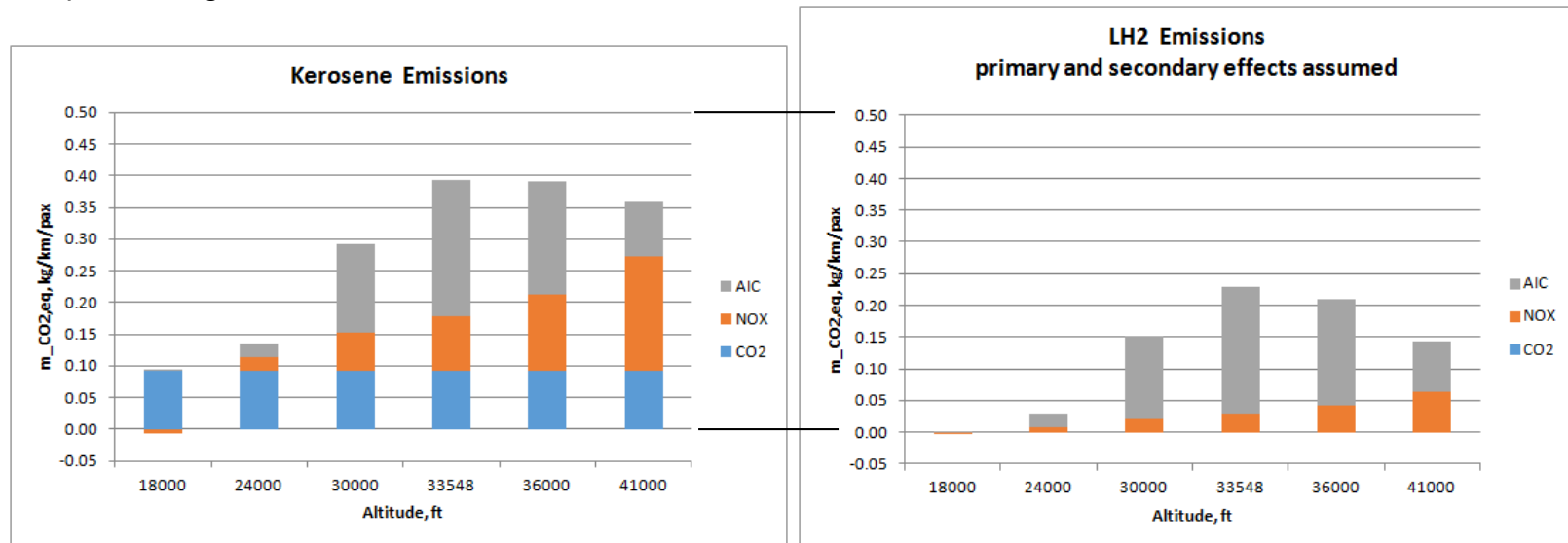

Now **secondary effects** are applied on top of the primary effect for **contrails** due to 3.333-fold larger ice crystals (factor 0.774) and for increase coverage (factor 1.2) leading all together to a **reduction factor** of $0.774 \cdot 1.2 = 0.929$. Note: This **factor** already **includes** the **2.58** for more water emissions. If the "2.58" are kept separately, the **reduction factor** is **0.358**! The **same factor** is **assumed** for cirrus clouds. For NOx a factor of 0.35 is **assumed** due to lean combustion and low flame temperature. With that **equivalent CO2 mass** is now in the order of that for **kerosene propulsion**.

Estimated Hydrogen Emission Effect – Unknown Ice Sphere Equivalent Diameter

d_eff_LH2 / d_eff_kero	f_red	f_red * 1.2	f_red * 1.2*2.58	f_final (33548 ft)
1.000	1.000	1.200	3.096	1.769
1.500	0.667	0.800	2.064	1.205
2.000	0.500	0.600	1.548	0.923
2.500	0.400	0.480	1.238	0.753
3.000	0.333	0.400	1.032	0.640
3.333	0.300	0.360	0.929	0.584
4.000	0.250	0.300	0.774	0.499
5.000	0.200	0.240	0.619	0.415
6.000	0.167	0.200	0.516	0.358

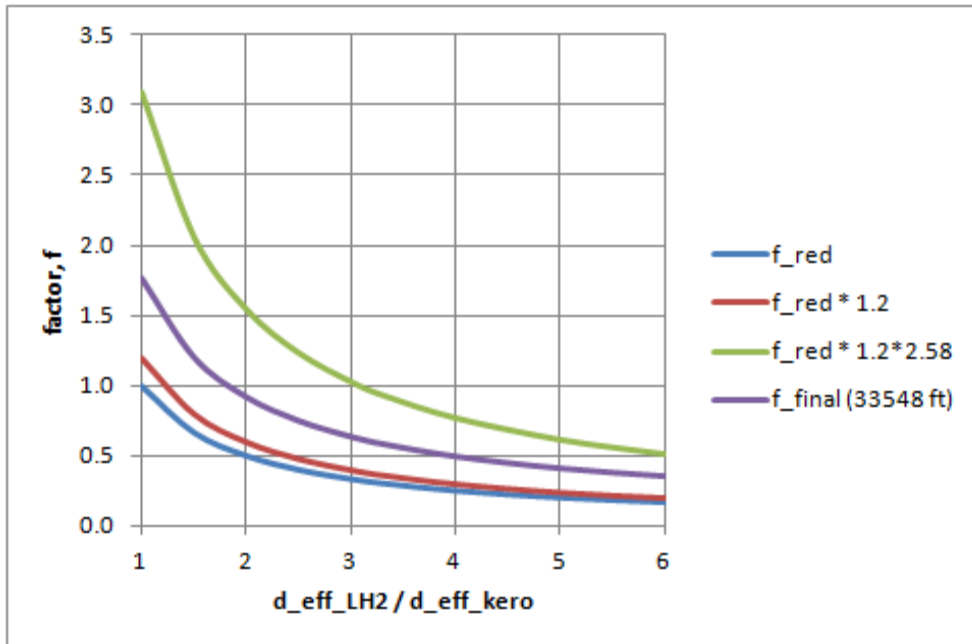

The "ice sphere model" gives a geometric reduction factor of $f_{red} = 1 / (d_{eff_LH2} / d_{eff_kero})$. It is calculated from the ratios of the equivalent diameter of the ice sphere in case of hydrogen combustion with respect to kerosene combustion.

According to Marquart 2005, contrail cover is increased by a factor of 1.2. This is due to contrails forming based on the Schmidt-Appleman Criterion and a slope G steeper by a factor of 2.58. The factor of 1.2 is a global estimate.

Hydrogen combustion produces more water for the same energy. The factor is 2.58.

Hydrogen combustion produces no CO2.

The possibility exists to reduce NOX if combustion chambers are applied to optimize hydrogen combustion. A factor of 0.35 is assumed.

The overall (final) reduction effect of hydrogen combustion depends on the composition of the equivalent CO2 mass. This is a strong function of altitude. According to the model by SCHWARTZ 2009 at peak AIC ("33548 ft") it is: 54.7% AIC, 23.6% CO2, and 21.7% NOX. Hydrogen emission reductions are calculated based on this composition.

Mitigating Aviation Emissions

Literature Review: Operational Measures to Avoid Contrails

Contrails cool the surface during the day and heat the surface during the night... Whereas the longwave (terrestrial) radiative forcing varies only little over the day, the shortwave (solar) forcing displays a strong diurnal cycle due to the variation of the sun's position (zenith angle). Hence... altering the time for aircraft traffic has the potential for reducing the radiative forcing due to contrails.

that most of the RF from contrails can be attributed to night-time flights. Even though only 25% of aircraft movements occur at night, they account for 60-80% of the contrails' RF.

although 22% of annual air traffic movements are winter flights, they contribute about half of the annual mean RF from contrails.

A strategy [can be] designed to achieve environmentally optimum flight routings (avoiding ice supersaturated air masses) especially for flights in the evening and night hours... As air traffic density is lower during the night, when contrails have a large individual radiative forcing, there is a greater opportunity for redirecting flights out of ice supersaturated regions without dramatically enhancing the work load of air traffic controllers.*

Gierens, 2008, <https://doi.org/10.2174/1874282300802010001>

* Redirecting flights can be done either laterally or vertically.

Hence, **only a small number of flights need to be redirected** e.g. to lower altitudes to achieve still a significant effect.



AIRCRAFT DESIGN AND SYSTEMS GROUP (AERO)

Conditions for Passenger Aircraft Minimum Fuel Consumption, Direct Operating Costs and Environmental Impact

Brecht Caers Hamburg University of Applied Sciences
Dieter Scholz

<https://doi.org/10.5281/zenodo.4068135>

Deutscher Luft- und Raumfahrtkongress 2020

German Aerospace Congress 2020

Online, 01 - 03.09.2020

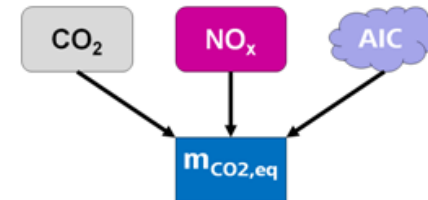

$$m_{CO_2,eq} = f(M, h)$$

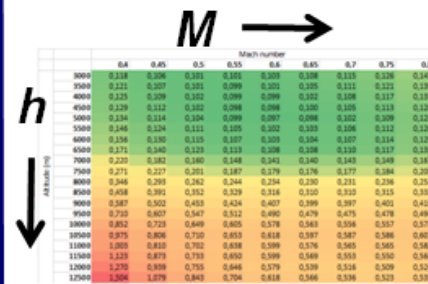

Environmental Impact – Flying Lower

		Mach number									
		0,4	0,45	0,5	0,55	0,6	0,65	0,7	0,75	0,8	
Altitude (m)	3000	0,053	0,023	0,012	0,011	0,018	0,035	0,058	0,092	0,155	
	3500	0,062	0,027	0,012	0,008	0,013	0,026	0,047	0,078	0,135	
	4000	0,072	0,032	0,013	0,006	0,008	0,019	0,037	0,064	0,117	
	4500	0,083	0,038	0,015	0,005	0,005	0,013	0,028	0,052	0,100	
	5000	0,097	0,046	0,018	0,006	0,002	0,008	0,020	0,042	0,085	
	5500	0,114	0,057	0,025	0,009	0,003	0,006	0,016	0,035	0,074	
	6000	0,133	0,068	0,032	0,012	0,003	0,004	0,012	0,028	0,065	
	6500	0,155	0,083	0,041	0,018	0,006	0,004	0,009	0,023	0,057	
	7000	0,192	0,110	0,062	0,035	0,020	0,015	0,018	0,030	0,061	
	7500	0,231	0,140	0,087	0,054	0,036	0,029	0,030	0,039	0,066	
	8000	0,282	0,180	0,119	0,082	0,060	0,050	0,048	0,055	0,079	
	8500	0,349	0,233	0,164	0,121	0,095	0,082	0,077	0,082	0,103	
	9000	0,425	0,294	0,215	0,166	0,135	0,118	0,111	0,112	0,131	
	9500	0,502	0,354	0,265	0,209	0,173	0,153	0,142	0,141	0,157	
	10000	0,589	0,422	0,320	0,256	0,215	0,190	0,176	0,172	0,184	
10500	0,675	0,481	0,364	0,289	0,241	0,211	0,193	0,186	0,196		
11000	0,685	0,483	0,361	0,284	0,234	0,203	0,185	0,178	0,189		
11500	0,769	0,535	0,394	0,305	0,247	0,211	0,188	0,178	0,186		
12000	0,867	0,591	0,426	0,322	0,255	0,211	0,184	0,170	0,175		
12500	1,000	0,677	0,485	0,364	0,285	0,234	0,201	0,183	0,184		

“Neutral” mix of 50 – 50 resource depletion and engine emissions

Clear altitude boundary from $m_{CO2,eq}$ visible

Fuel consumption shape visible

Fly low and slow

Units: normalized value between 0 and 1

Environmental Impact – Flying Lower

Changing the regular cruise altitude of an Airbus A320-200 of about 11500 m to an altitude of 6500 m at a constant Mach 0.78 would result in:

- a decrease of equivalent CO₂ mass of 78 % and
- an increase of fuel consumption of 5.6 %.

The increase of fuel consumption is mostly influenced by

- an increase of TSFC of 6.0 % and
- a decrease of the aerodynamic efficiency of 5.4 %.

Combining equivalent CO₂ mass and resource depletion (fuel consumption) into the environmental impact would result in a decrease of 70 % in environmental impact.

As the Mach number is kept constant, DOC are only effected by fuel consumption and increase by only 0.6%.

However, for the atmosphere this is an exchange of considerable less short term non-CO₂ warming potential versus more CO₂ long term warming potential. This exchange can be questioned, because it is not good for future generations.

Redirecting Flights

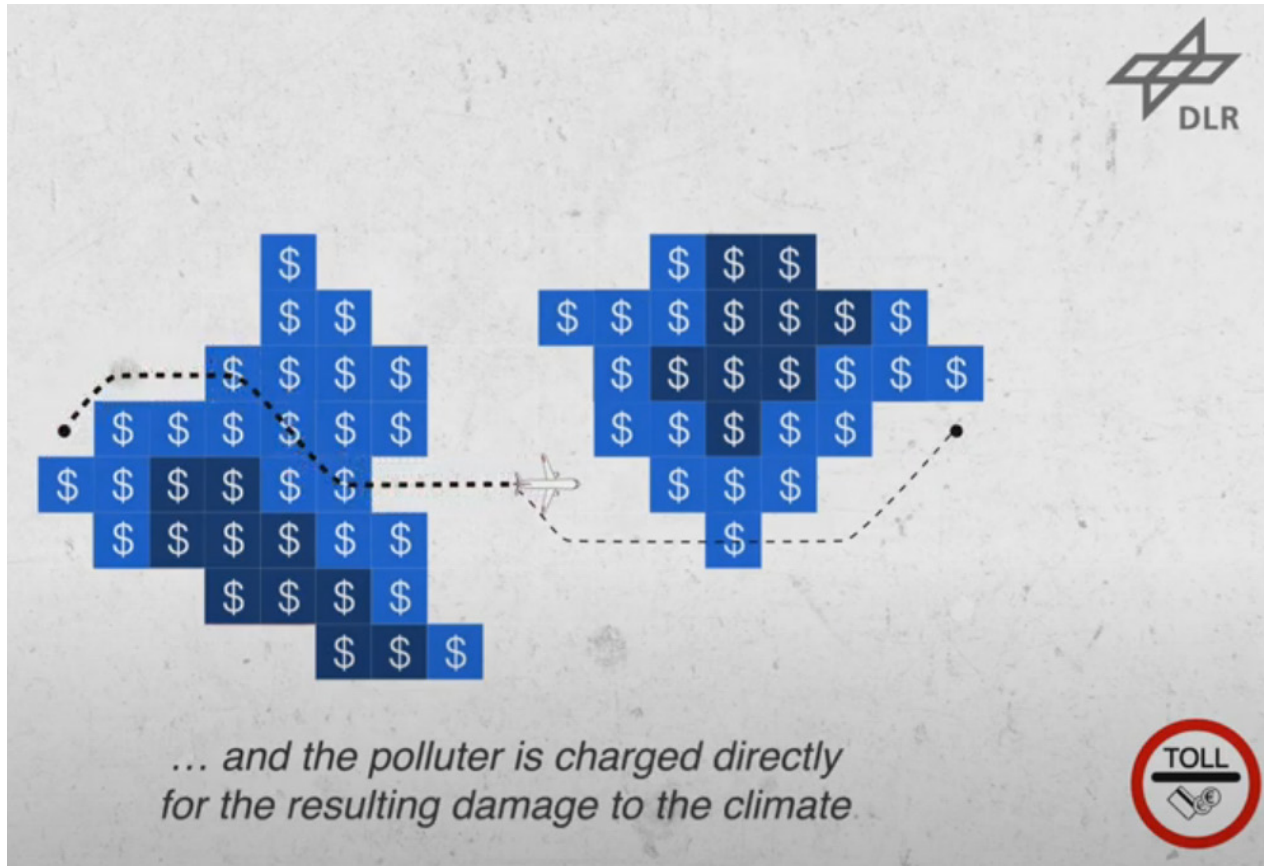

The concepts of **climate-restricted airspaces** (regulatory approach) and **climate-charged airspaces** (price-based approach) show their mitigation potential. A trajectory simulation in the North Atlantic shows that more than 90% of the maximum mitigation potential of eco-efficient flying can be achieved by these concepts. The concepts resolve the existing conflict of objectives between ecology and economy in aviation. **Climate-friendly flying becomes economically attractive.**

Climate Charged Airspaces, <https://youtu.be/BZbOANbAG-A>

NIKLAß, Malte, 2019. *Ein systemanalytischer Ansatz zur Internalisierung der Klimawirkung der Luftfahrt*. Dissertation. Available from: <https://elib.dlr.de/126415>

Summary

Aviation and the Climate – An Overview

Summary (1 of 2)

- When fossil fuels come to an end, **we need an efficient energy carrier** to bring renewable energies (electricity) into the aircraft.
- At the same time we need to **make sure that flying is done with as little emissions** as possible.
- An **aircraft flying with PtL compared with** one flying on **hydrogen needs** $2.7/1.4 = 1.9$, or **roughly two times more primary energy**.
- **Cryoplanes** need lean combustion for low NO_x and **should fly lower** to limit contrails.
- Research in contrails forming behind a hydrogen aircraft is needed. This research should find the average equivalent diameter of the ice crystals in case of hydrogen combustion.
- For decades to come we will have an electricity energy mix including fossil fuels and renewable energies. No one should claim the clean energy and leave the dirty energy to others.
- With **all measures** together, cryoplanes can **reduce emissions** (tank to wake) down to $59\% \cdot 1.4 = 83\%$ compared to kerosene planes (this is a reduction of **17%**). **Considering** however **the energy mix**, cryoplanes are **as polluting as the kerosene planes**. All the efforts do not pay off related to *overall* emissions!

* Strongly depending on cruise altitude (here for peak AIC).

Aviation and the Climate – An Overview

Summary (2 of 2)

- Cryoplane emission are more short term than the CO2 long term emissions from kerosene aircraft. This means that **in the long term, cryoplanes burden future generations less with global warming**. If we fly cryoplanes today, less CO2 piles up. Future generations could decide to stop (or reduce) flying and will see an immediate effect when cutting the short term non-CO2 effects.
- **Renewable energy** will by far **not** be **sufficient to maintain flying at the level we know today** (2019).
- It is therefore paramount to **reduce flying** as it happened already during the Corona pandemic. If we do not gently start changing the aviation industry now (while change takes place), the laws of physics will tell us, with the consequence that our children will later struggle harder to make this transformation.

Contact

info@ProfScholz.de

<http://www.ProfScholz.de>

Quote this document:

SCHOLZ, Dieter, 2022. *Aviation and the Climate – An Overview*.
Hamburg Aerospace Lecture Series, Online, 27.01.2022.
Available from: <https://doi.org/10.5281/zenodo.xxxxxxx>

Copyright by Author, CC BY-NC-SA, <https://creativecommons.org/licenses/by-nc-sa/4.0>



Video "The Bill"

Watch "The Bill", a short video (4:21).

The video may make you think about how we live and what we really need.

<https://youtu.be/EmirohM3hac> (German)

<https://youtu.be/rWfb0VMCQHE> (English Subtitles)

